



INSTRUCTION MANUAL

DUAL BAND FM TRANSCEIVER
IC-2725E



Icom Inc.

FOREWORD

Thank you for purchasing this Icom product. The IC-2725E VHF/UHF FM TRANSCEIVER is designed and built with Icom's superior technology and craftsmanship. With proper care, this product should provide you with years of trouble-free operation.

We want to take a couple of moments of your time to thank you for making your IC-2725E your radio of choice, and hope you agree with Icom's philosophy of "technology first." Many hours of research and development went into the design of your IC-2725E.

◆ FEATURES

- *V/V, U/U simultaneous receive capability*
- *Independent controls for each left and right bands*
- *Separate controller for flexible installation*
- *50 W* of high transmit output power*
*VHF band; 35 W for UHF
- *Remote control microphone standard*
- *New DMS (Dynamic Memory Scan) system*

IMPORTANT

READ ALL INSTRUCTIONS carefully and completely before using the transceiver.

SAVE THIS INSTRUCTION MANUAL— This instruction manual contains important operating instructions for the IC-2725E.

EXPLICIT DEFINITIONS

WORD	DEFINITION
⚠ WARNING!	Personal injury, fire hazard or electric shock may occur.
CAUTION	Equipment damage may occur.
NOTE	Recommended for optimum use. No risk of personal injury, fire or electric shock.

Icom, Icom Inc. and the ICOM logo are registered trademarks of Icom Incorporated (Japan) in the United States, the United Kingdom, Germany, France, Spain, Russia and/or other countries.

PRECAUTION

⚠ WARNING RF EXPOSURE! This device emits Radio Frequency (RF) energy. Extreme caution should be observed when operating this device. If you have any questions regarding RF exposure and safety standards please refer to the Federal Communications Commission Office of Engineering and Technology's report on Evaluating Compliance with FCC Guidelines for Human Radio frequency Electromagnetic Fields (OET Bulletin 65).

⚠ WARNING! NEVER connect the transceiver to an AC outlet. This may pose a fire hazard or result in an electric shock.

⚠ WARNING! NEVER operate the transceiver while driving a vehicle. Safe driving requires your full attention—anything less may result in an accident.

NEVER connect the transceiver to a power source of more than 16 V DC. This will damage the transceiver.

NEVER connect the transceiver to a power source using reverse polarity. This will damage the transceiver.

NEVER cut the DC power cable between the DC plug and fuse holder. If an incorrect connection is made after cutting, the transceiver may be damaged.

NEVER expose the transceiver to rain, snow or any liquids. The transceiver may be damaged.

NEVER operate or touch the transceiver with wet hands. This may result in an electric shock or damage the transceiver.

NEVER place the transceiver where normal operation of the vehicle may be hindered or where it could cause bodily injury.

NEVER let objects impede the operation of the cooling fan on the rear panel.

DO NOT push the PTT when not actually desiring to transmit.

DO NOT allow children to play with any radio equipment containing a transmitter.

During mobile operation, **DO NOT** operate the transceiver without running the vehicle's engine. When the transceiver's power is ON and your vehicle's engine is OFF, the vehicle's battery will soon become exhausted.

BE CAREFUL! The transceiver will become hot when operating it continuously for long periods.

AVOID using or placing the transceiver in direct sunlight or in areas with temperatures below -10°C or above $+60^{\circ}\text{C}$.

AVOID the use of chemical agents such as benzine or alcohol when cleaning, as they can damage the transceiver's surfaces.

USE Icom microphones only (supplied or optional). Other manufacturer's microphones have different pin assignments and may damage the transceiver if attached.

/// IMPORTANT!

/// Detailed installation notes for Icom mobile transceivers to be fitted into vehicles are available. Contact your Icom dealer or distributor.

SUPPLIED ACCESSORIES

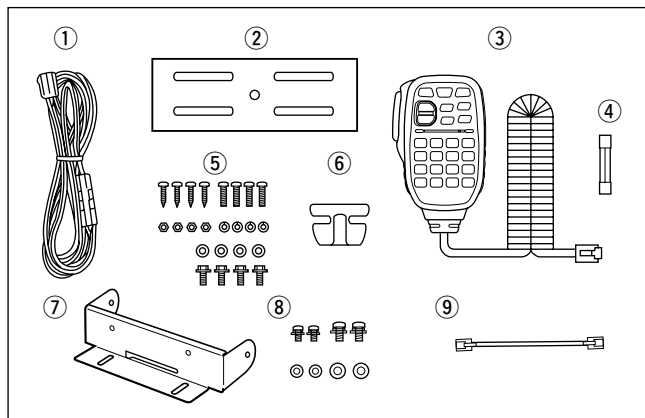

- ① DC power cable (3 m) 1
- ② Mobile mounting bracket 1
- ③ Microphone (HM-133)* 1
- ④ Fuse (20 A) 1
- ⑤ Mounting screws, nuts and washers 1 set
- ⑥ Microphone hanger 1
- ⑦ Remote controller bracket (MB-85) 1
- ⑧ Mounting screws and washers for MB-85 1 set
- ⑨ Separation cable (20 cm) 1

*HM-118N HAND MICROPHONE OR HM-118TN/TAN DTMF MICROPHONE supplied versions are also available.

TABLE OF CONTENTS

FOREWORD	i
IMPORTANT	i
EXPLICIT DEFINITIONS	i
PRECAUTION	ii
SUPPLIED ACCESSORIES	iii
TABLE OF CONTENTS	iii
QUICK REFERENCE GUIDE	I–XII
■ Installation	I
■ Your first contact	VIII
■ Repeater operation	X
■ Programming memory channels.....	XI
1 PANEL DESCRIPTION	1–10
■ Front panel— controller	1
■ Function display	3
■ Main unit	5
■ Microphone (HM-133)	7
■ Microphone keypad	8
■ Optional microphones (HM-118N/TN).....	10
2 SETTING A FREQUENCY	11–15
■ Preparation	11
■ Using the tuning dial	13
■ Using the [▲]/[▼] keys	13
■ Using the keypad	13
■ Tuning step selection	14
■ Lock functions	15
3 BASIC OPERATION	16–21
■ Receiving	16
■ Monitor function	16
■ Squelch attenuator	17
■ V/V, U/U simultaneous receive (Para-watch)	18
■ Sub band mute/sub band busy beep	19
■ Transmitting	20

■ Selecting output power	20	9 DTMF MEMORY ENCODER	47–50
■ One-touch PTT function	21	■ Programming a DTMF code	47
■ Audio mute function	21	■ Transmitting a DTMF code	49
4 REPEATER OPERATION	22–28	■ DTMF speed	50
■ General	22	10 POCKET BEEP AND TONE SQUELCH	51–54
■ Accessing a repeater	23	■ Pocket beep operation	51
■ Subaudible tones	25	■ Tone/DTCS squelch operation	53
■ Offset frequency	27	■ Tone scan	54
5 MEMORY OPERATION	28–36	11 OTHER FUNCTIONS	55–70
■ General description	28	■ Set mode	55
■ Memory channel selection	28	■ Initial set mode	59
■ Programming a memory channel	29	■ AM/FM narrow mode	63
■ Transferring memory contents	31	■ Microphone keys	64
■ Memory clearing	33	■ Partial reset	65
■ Memory bank selection	34	■ All reset	65
■ Memory bank setting	35	■ Data cloning	66
■ Transferring bank contents	36	■ Packet operation	67
6 CALL CHANNEL OPERATION	37–38	12 MAINTENANCE	71–72
■ Call channel selection	37	■ Troubleshooting	71
■ Call channel transferring	37	■ Fuse replacement	72
■ Programming a call channel	38	13 SPECIFICATIONS AND OPTIONS	73–74
7 SCAN OPERATION	39–44	■ Specifications	73
■ Scan types	39	■ Options	74
■ Scan start/stop	40	14 MODE ARRANGEMENT	75–76
■ Scan edges programming	41	15 CE	77
■ Skip channel setting	43		
■ Scan resume condition	44		
8 PRIORITY WATCH	45–46		
■ Priority watch types	45		
■ Priority watch operation	46		

1
2
3
4
5
6
7
8
9
10
11
12
13
14
15

QUICK REFERENCE GUIDE

■ Installation

◇ Installation methods

• *Single body installation*

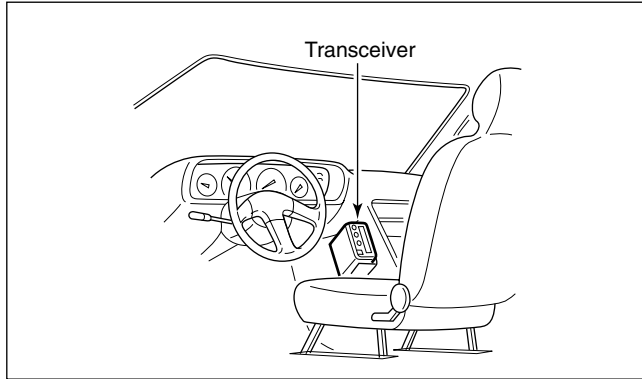

- The supplied MB-85 COMBINATION BRACKET is used to mount the controller to the main unit. (Use the supplied 20 cm separation cable.)
- The supplied mounting bracket (or optional MB-17A) can be used for the main unit installation.

• *Remote installation*

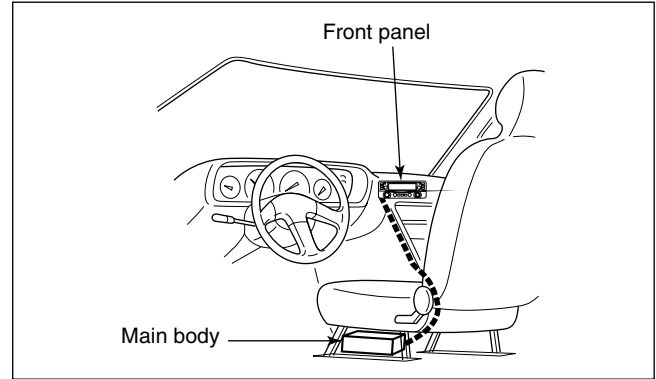

- Optional MB-84 REMOTE CONTROLLER BRACKET and OPC-1155 SEPARATION CABLE can be used for installation.
- Optional OPC-1156 SEPARATION CABLE (3.5 m) is available for extend the separation cable.
- Optional MB-65 MOUNTING BASE is available for increasing front panel mounting possibilities.
- Optional OPC-440 MICROPHONE CABLE (5.0 m) and OPC-647 (2.5 m) are available to extend the microphone cable.
- Optional OPC-441 SPEAKER CABLE (5.0 m) is available to extend the speaker cable.

◇ **Location**

Select a location which can support the weight of the transceiver and does not interfere with driving. We recommend the locations shown in the diagram below.

NEVER place the transceiver or remote controller where normal operation of the vehicle may be hindered or where it could cause bodily injury.

NEVER place the transceiver or remote controller where air bag deployment may be obstructed.

DO NOT place the transceiver or remote controller where hot or cold air blows directly onto it.

AVOID placing the transceiver or remote controller in direct sunlight.

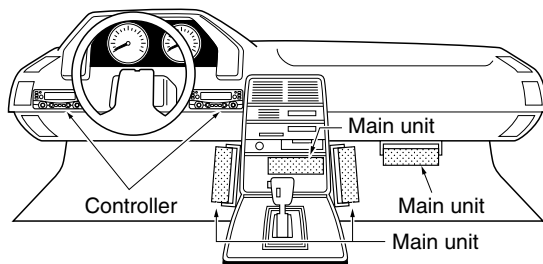

◇ **Using the mounting bracket**

- ① Drill 4 holes where the mounting bracket is to be installed.
 - Approx. 5.5–6 mm when using nuts; approx. 2–3 mm when using self-tapping screws.
- ② Insert the supplied screws, nuts and washers through the mounting bracket and tighten.
- ③ Adjust the angle for your suitable position.

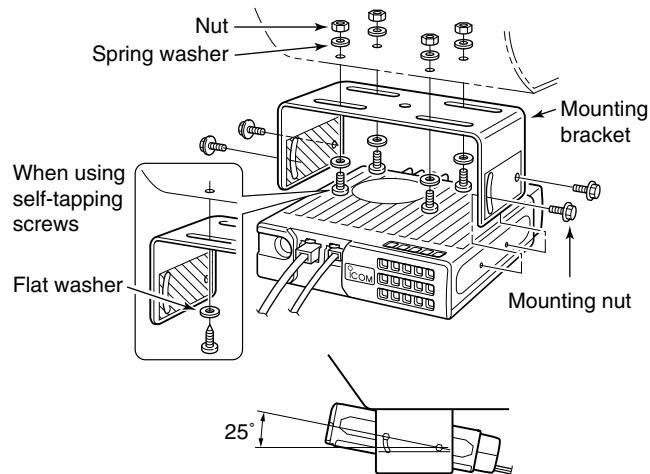

IMPORTANT!

Detailed installation notes for Icom mobile transceivers to be fitted into vehicles are available. Contact your Icom dealer or distributor.

QUICK REFERENCE GUIDE

◇ MB-85 installation

When using the supplied MB-85 (COMBINATION BRACKET), you can install the control head of the IC-2725E in one of 2 methods. A 20 cm remote control cable is supplied for connection, and connect the cable before attaching the bracket to the main unit is recommended.

• Example 1

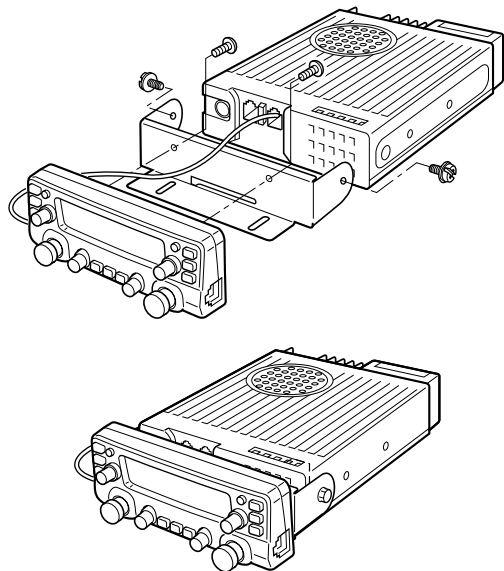

• Example 2

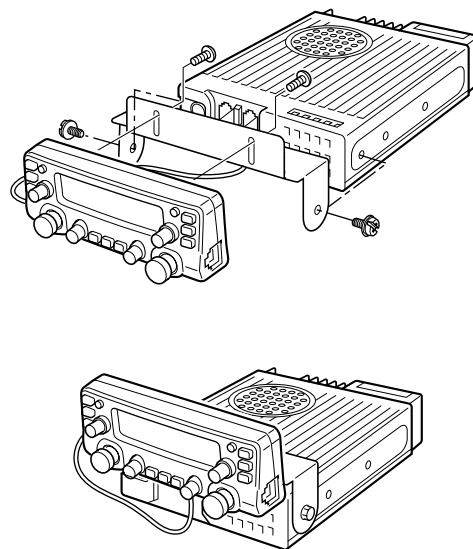

◇ **Optional MB-84 installation**

The optional MB-84 REMOTE CONTROLLER BRACKET IS used for separate installation.

- ① Drill 2 holes where the bracket is to be installed.
 - Approx. 4 mm when using nuts; approx. 1–2 mm when using self-tapping screws.

• **Over-head mounting**

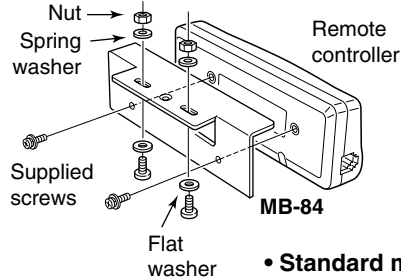

• **Standard mounting**

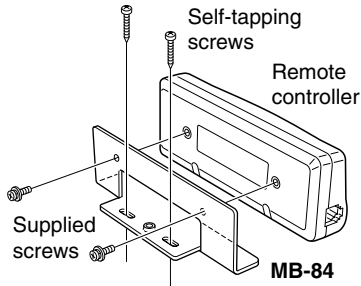

- ② Attach the remote controller to the MB-84 and tighten the controller using with the supplied screws.
- ③ Tighten the controller with bracket.

• **Using the optional MB-65**

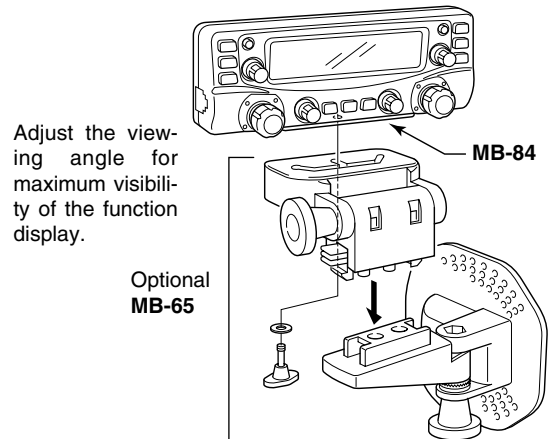

QUICK REFERENCE GUIDE

◇ Separation cable connection

A separation cable (20 cm) is supplied with the IC-2725E. Connect the controller and the main unit using with the separation cable as follows.

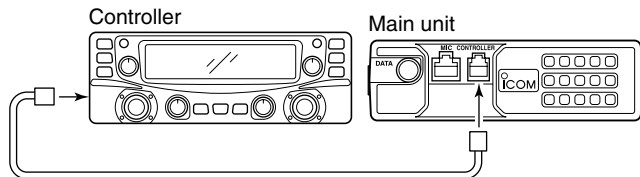

IMPORTANT!— When using the optional OPC-1155

A ferrite core is supplied within the OPC-1155. Connect the cable connector with the ferrite core into the main unit [CONTROLLER] socket as below.

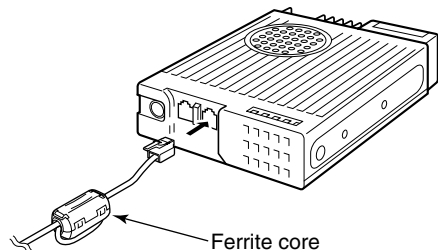

◇ Microphone connection

Two microphone connectors are available for the IC-2725E—one is on the controller side panel, and another is on the main unit front panel.

Connect the supplied microphone to either the desired connector as illustrated below.

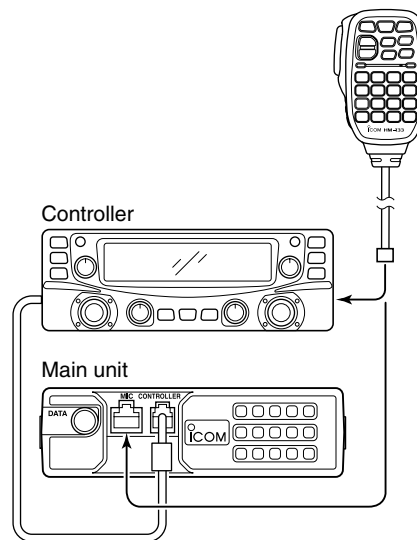

◇ **Battery connection**

- ⚠ **WARNING NEVER** remove the fuse holders from the DC power cable.
- ⚠ **NEVER** connect the transceiver directly to a 24 V battery.
- ⚠ **DO NOT** use the cigarette lighter socket for power connections. (See p. 6 for details)

Attach a rubber grommet when passing the DC power cable through a metal plate to prevent a short circuit.

• **CONNECTING TO A DC POWER SOURCE**

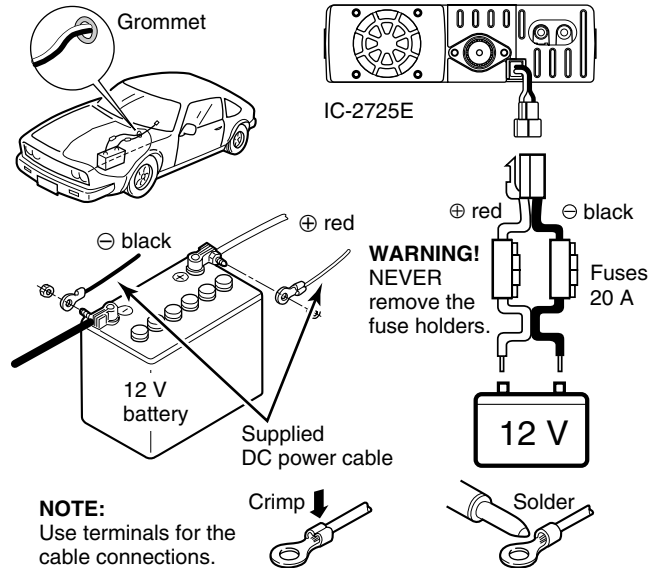

NOTE:
Use terminals for the cable connections.

◇ **DC power supply connection**

Use a 13.8 V DC power supply with at least 15 A capacity.

Make sure the ground terminal of the DC power supply is grounded.

• **CONNECTING TO A DC POWER SUPPLY**

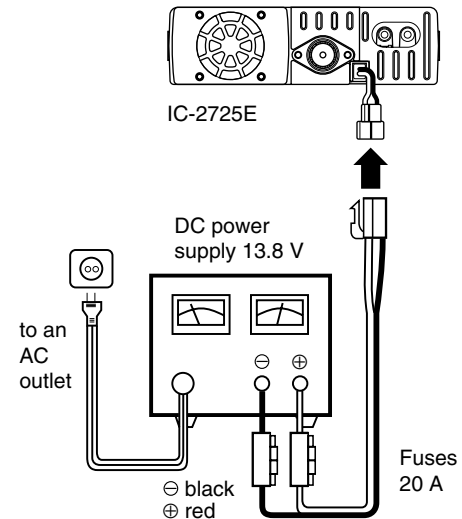

See p. 72 for fuse replacement.

QUICK REFERENCE GUIDE

◇ Antenna installation

• Antenna location

To obtain maximum performance from the transceiver, select a high-quality antenna and mount it in a good location. A non-radial antenna should be used when using a magnetic mount.

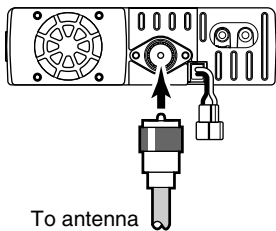
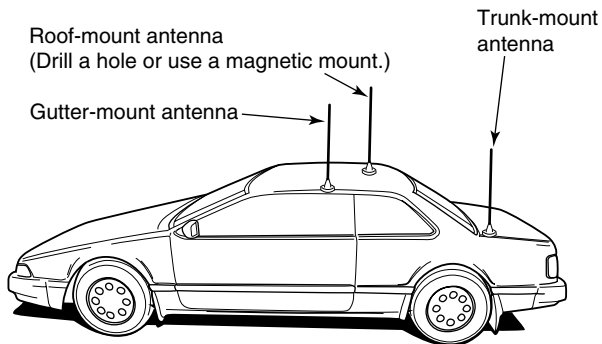

• Antenna connector

The antenna uses a PL-259 connector.

• PL-259 CONNECTOR

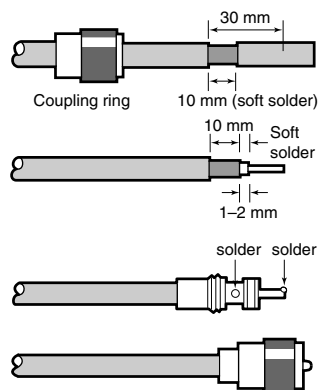

- ① Slide the coupling ring down. Strip the cable jacket and soft solder.
- ② Strip the cable as shown at left. Soft solder the center conductor.
- ③ Slide the connector body on and solder it.
- ④ Screw the coupling ring onto the connector body.

NOTE: There are many publications covering proper antennas and their installation. Check with your local dealer for more information and recommendations.

■ Your first contact

Now that you have your IC-2725E installed in your car or shack, you are probably excited to get on the air. We would like to take you through a few basic operation steps to make your first “On The Air” an enjoyable experience.

1. Turning ON the transceiver

Before powering up your IC-2725E, you may want to make sure the audio volume and squelch level controls are set in 9–10 o'clock positions.

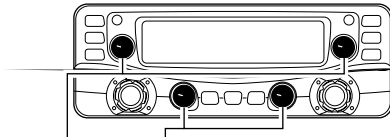

Set both [VOL] and [SQL] controls to 9–10 o'clock positions.

Although you have purchased a brand new transceiver, some settings may be changed from the factory defaults because of the QC process. Resetting the CPU is necessary to start from factory default.

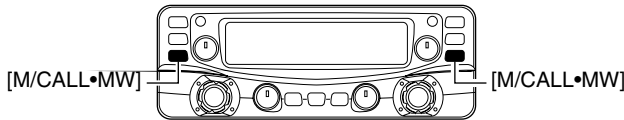

While pushing both [M/CALL•MW], turn power ON.

➔ While pushing both band's [M/CALL•MW], push [PWR] for 1 sec. to reset the CPU.

2. Selecting the main band

The IC-2725E displays 2 frequencies on left and right bands simultaneously. However, transmission, some switches and microphone keys operation are accepted for the main band only.

Push the desired band's [MAIN•BAND]

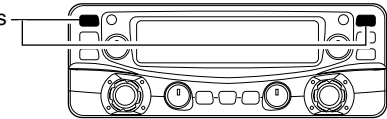

➔ Push the desired band's (left or right) [MAIN•BAND] to select the main band.

- “MAIN” appears for the main band.

Using the HM-133

You can select the main band from the HM-133.



Push [BAND]

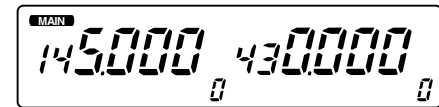

Push [BAND] again

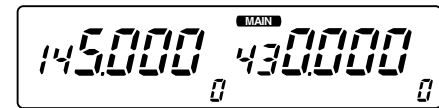

QUICK REFERENCE GUIDE

3. Selecting the operating frequency band

The IC-2725E has 2 m and 70 cm bands for each left and right band. The operating band can be exchanged between them, and the same bands, V/V and U/U settings, also possible.

Push the desired band's [MAIN•BAND] for 1 sec.

[DIAL]

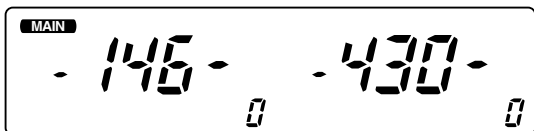
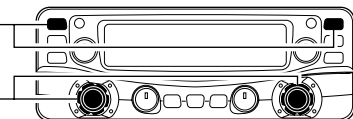

Frequency band initial is displayed.

- ➔ Push the desired band's (left or right) [MAIN•BAND] for 1 sec. then rotate the appropriate band's [DIAL].
- Push the [MAIN•BAND] momentarily to return to frequency indication.

4. Tune the frequency

The tuning dial will allow you to dial in the frequency you want to operate. Pages 13 and 14 will instruct you on how to set the tuning speed.

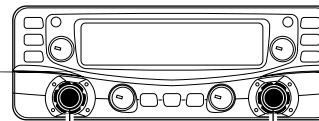

Rotate the desired [DIAL].

Using the HM-133

You can directly enter the frequency with the HM-133 keypad for the main band.

[EXAMPLE]: Setting frequency to 145.3625 MHz.

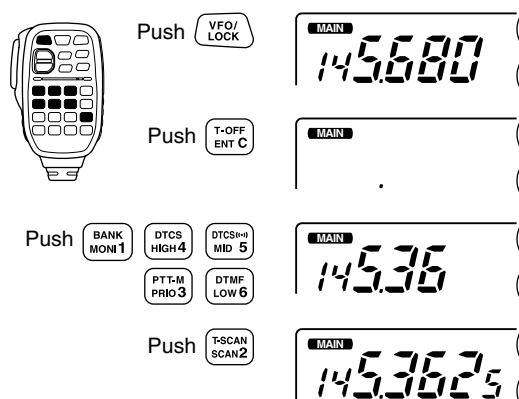

■ Repeater operation

1. Setting duplex

Push desired band's [MAIN•BAND] to select the main band.
Push [DUP•MONI] once or twice to select minus duplex or plus duplex.

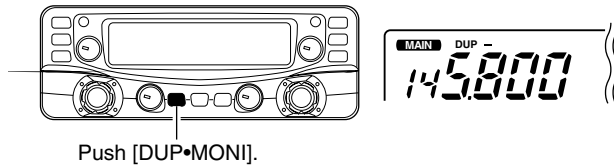

2. Repeater tone

Push [TONE•DTMF] several times until "T" appears, if the repeater requires a subaudible tone to be accessed.

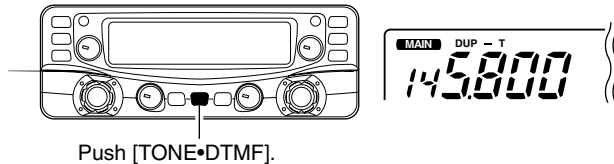

Using the HM-133

Plus or minus duplex selection and the repeater tone setting can be made easily via HM-133.

Push [DUP- 7(TONE)] for minus duplex; [DUP+ 8(TSQL ((•)))] for plus duplex selection, push [FUNC] then [DUP- 7(TONE)] to turn the repeater tone ON.

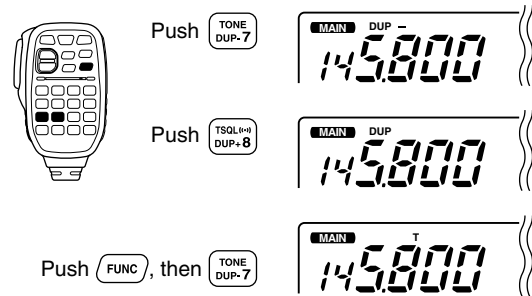

■ Programming memory channels

The IC-2725E has a total of 212 memory channels (including 10 scan edges and 2 call channels) for storing often used operating frequency, repeater settings, etc.

Any memory channel can be recalled from either left or right band.

1. Setting a frequency

In VFO mode, set the desired operating frequency with repeater, tone and tuning steps, etc.

- Push the desired band's [V/MHz•SCAN] to select VFO.
- Rotate the same band's [DIAL] to set the desired frequency.
 - Set other data, such as repeater tone, duplex information, tuning step), if desired.

2. Selecting a memory channel

Push the same band's [M/CALL•MW] for 1 sec., then rotate the [DIAL] to select the desired memory channel.

- “[M]” indicator and memory channel number blink.

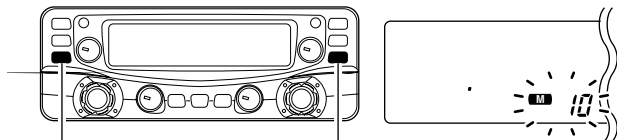

Push [M/CALL•MW] for 1 sec.

3. Writing a memory channel

Push and hold the [M/CALL•MW] for 1 sec. to program.

- 3 beeps sound
- Return to VFO mode automatically after the program.
- Memory channel number automatically increases when continuing to push the [M/CALL•MW] after programming.

Using the HM-133

- ① In VFO mode, set the desired operating frequency, including offset direction, tone settings, etc.
 - ➔ Push [VFO/LOCK] to select VFO.
 - ➔ Push [ENT C(T-OFF)] first, then enter the desired operating frequency via the keypad.
 - Set other data, such as repeater tone, duplex information, tuning step, if necessary.
- ② Push [FUNC] then [CLR A(MW)].
 - “**M**” indicator and memory channel number blink.

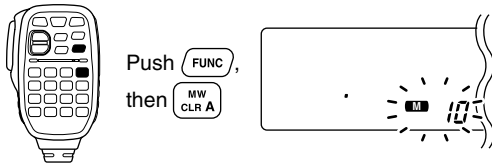

- ③ Push [▲]/[▼] to select the desired memory channel.
- ④ Push [FUNC] then push [CLR A(MW)] for 1 sec. to program.
 - 3 beeps sound
 - Memory channel number automatically increases when continuing to push [CLR A(MW)] after programming.

1

PANEL DESCRIPTION

■ Front panel— controller

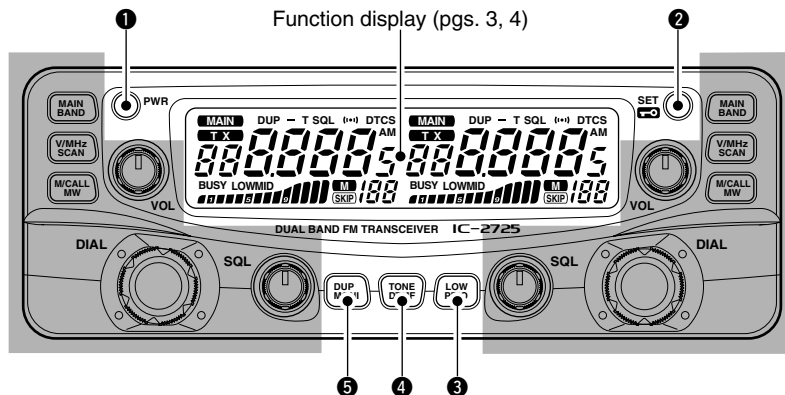

*The switches ② to ⑤ are for the MAIN band only.

① POWER SWITCH [PWR]

Turns power ON and OFF when pushed for 1 sec.

② SET•LOCK SWITCH [SET•

➔ Enters set mode when pushed. (p. 55)

➔ Switches the lock function ON and OFF when pushed for 1 sec. (p. 15)

③ OUTPUT POWER•PRIORITY SWITCH [LOW•PRIO]

➔ Each push changes the output power selection. (p. 20)

➔ Starts priority watch when pushed for 1 sec. (p. 46)

④ TONE•DTMF SWITCH [TONE•DTMF]

➔ Each push selects a tone function. (pgs. 23, 51)

- Subaudible tone encoder, pocket beep (CTCSS), tone squelch, pocket beep (DTCS), DTCS squelch or tone function OFF can be selected.

➔ Turns DTMF memory encoder ON and OFF when pushed for 1 sec. (p. 47)

⑤ DUPLEX•MONITOR SWITCH [DUP•MONI]

➔ Push to select DUP-, DUP+ and simplex operation. (p. 23)

➔ Push for 1 sec. to switch the monitor function ON and OFF. (p. 16)

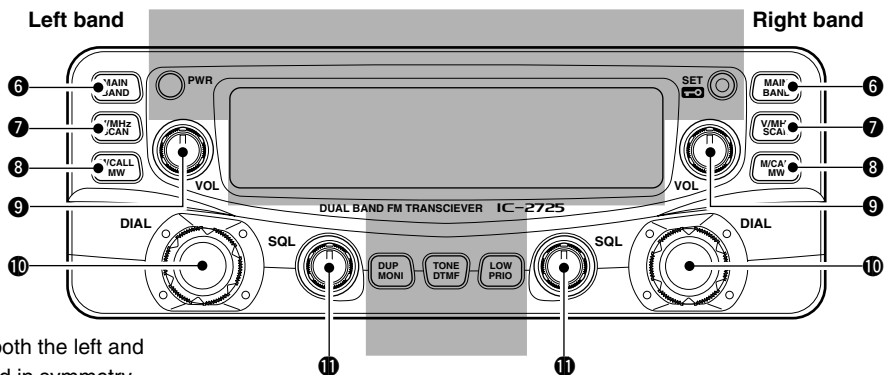

*The same controls for both the left and right bands are arranged in symmetry.

6 MAIN BAND SWITCH [MAIN BAND]

- ➔ Push to select the main band. (p. 11)
- ➔ Enters operating band select condition when pushed for 1 sec. (p. 11)

7 VFO/MHz TUNING SCAN SWITCH [V/MHz SCAN]

- ➔ Selects and toggles VFO mode and 1 MHz (or 10 MHz for some versions) tuning when pushed. (p. 13)
- ➔ Starts scan when pushed for 1 sec. (p. 40)
 - Cancels a scan when pushed during scan.

8 MEMORY/CALL MEMORY WRITE SWITCH [M/CALL MW]

- ➔ Push to select and toggle memory and call channel modes. (pgs. 12, 28, 37)
- ➔ Selects a memory channel for programming when pushed for 1 sec. (pgs. 29, 38, 41)

9 VOLUME CONTROL [VOL] (p. 16)

Adjusts the audio level for relative band.

10 TUNING DIAL [DIAL]

Selects the operating frequency (p. 13), memory channel (p. 28), the setting of the set mode item and the scanning direction (p. 40) for the relative band.

11 SQUELCH CONTROL [SQL]

Varies the squelch level for relative band. (p. 16)

- The RF attenuator activates and increases the attenuation when rotated clockwise to the center position and further. (p. 17)

1 PANEL DESCRIPTION

■ Function display

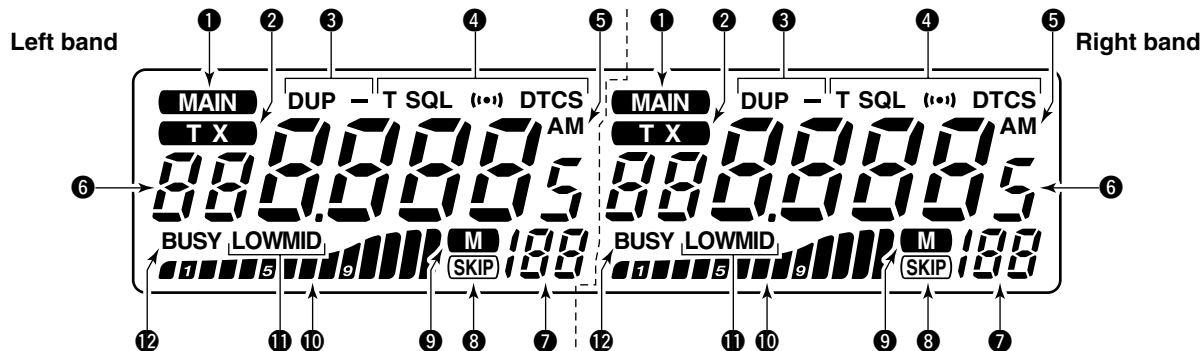

*The same indications for both the left and right bands are arranged.

① MAIN INDICATOR (p. 11)

Indicate the main band for transmit and function control.

② TRANSMIT INDICATOR

- ➔ Appears while transmitting. (p. 20)
- ➔ Blinks while transmitting with the one-touch PTT function. (p. 21)

③ DUPLEX INDICATORS (p. 23)

“DUP” appears when plus duplex, “DUP -” appears when minus semi-duplex (repeater) operation is selected.

④ TONE INDICATORS

- ➔ “T” appears while the subaudible tone encoder is in use. (p. 23)
- ➔ “T SQL” appears while the tone squelch function is in use. (p. 51)
- ➔ “DTCS” appears while the DTCS squelch function is in use. (p. 51)
- ➔ “((·))” appears with the “T SQL” or “DTCS” indicator while the pocket beep function (with CTCSS or DTCS) is in use. (p. 51)

5 AM INDICATOR (p. 63)

Appears when AM mode is selected.

6 FREQUENCY READOUT

Shows the operating frequency, set mode contents, etc.

- Frequency decimal point blinks while scanning. (p. 40)
- “d” appears in place of the 1st digit while the DTMF memory function is in use. (p. 47)

7 MEMORY CHANNEL NUMBER INDICATORS

- Shows the selected memory channel number. (p. 28)
- Shows the selected bank initial. (p. 34)
- “C” appears when the call channel is selected. (p. 37)
- “L” appears when the lock function is activated. (p. 15)

8 SKIP INDICATOR (p. 43)

Appears when the displayed memory channel is specified as a skip channel.

9 MEMORY INDICATOR (pgs. 12, 28)

Appears when memory mode is selected.

10 S/R F INDICATORS

- Shows the relative signal strength while receiving signals. (p. 16)
- Shows the output power level while transmitting. (p. 20)

11 OUTPUT POWER INDICATORS

“LOW” appears when low output power; “MID” appears when middle output power is selected.

No indicator appears when high output power is selected.

12 BUSY INDICATOR

- Appears when a signal is being received or the squelch is open. (p. 16)
- Blinks while the monitor function is activated. (p. 16)

1 PANEL DESCRIPTION

■ Main unit

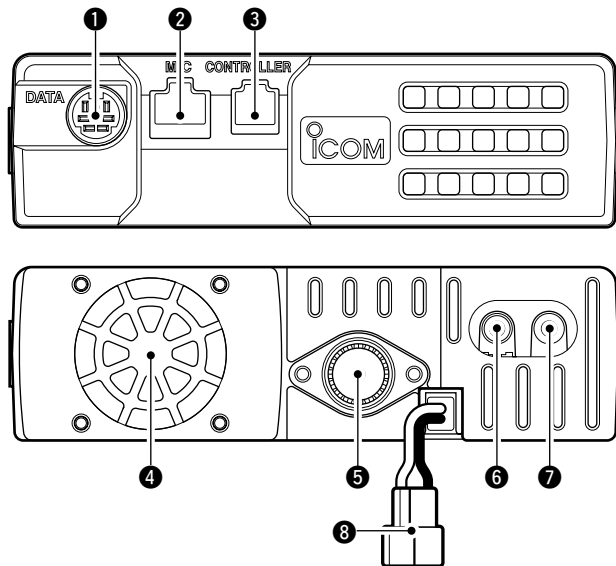

① DATA SOCKET [DATA]

Connects a TNC (Terminal Node Controller), etc. for data communications.

- See p. 6 for connection information.

② MICROPHONE CONNECTOR [MIC]

Connects the supplied or an optional microphone.

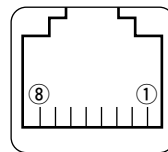

- ① +8 V DC output (Max. 10 mA)
- ② Channel up/down
- ③ 8 V control IN
- ④ PTT
- ⑤ GND (microphone ground)
- ⑥ MIC (microphone input)
- ⑦ GND
- ⑧ Data IN

③ CONTROLLER CONNECTOR [CONTROLLER] (p. V)

Connects the controller unit with the supplied cable.

④ COOLING FAN

Rotates while transmitting.

Also rotates while receiving depending on the setting in initial set mode. (p. 60)

⑤ ANTENNA CONNECTOR [ANT]

Connects a 50 Ω antenna with a PL-259 connector and a 50 Ω coaxial cable.

ANTENNA INFORMATION

For radio communications, the antenna is of critical importance, to maximize your output power and receiver sensitivity. The transceiver accepts a 50 Ω antenna and less than 1:1.5 of Voltage Standing Wave Ratio (VSWR). High SWR values not only may damage the transceiver but also lead to TVI or BCI problems.

6 EXTERNAL SPEAKER JACK 1 [SP-1]

Connects an 8 Ω speaker. Outputs both left and right bands audio when no external speaker is connected to [SP-2]. See the table below for details.

- Audio output power is more than 2.4 W.

7 EXTERNAL SPEAKER JACK 2 [SP-2]

Connects an 8 Ω speaker. Outputs right band's audio only.

- Audio output power is more than 2.4 W.

8 POWER RECEPTACLE [DC13.8V]

Accepts 13.8 V DC ±15% with the supplied DC power cable.

NOTE: DO NOT use a cigarette lighter socket as a power source when operating in a vehicle. The plug may cause voltage drops and ignition noise may be superimposed onto transmit or receive audio.

◇ Speaker information

Connected speaker	Left band audio	Right band audio
No external speakers	Internal speaker (mixed audio)	
[SP-1] only	External speaker (mixed audio)	
[SP-2] only	Internal speaker	External speaker
2 external speakers	External speaker via [SP-1]	External speaker via [SP-2]

◇ DATA JACK PIN ASSIGNMENT

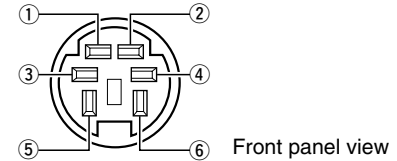

① DATA IN

Input terminal for data transmit. See p. 67 for details on how to toggle data speed between 1200 (AFSK) and 9600 bps (G3RUH, GMSK).

② GND

Common ground for DATA IN, DATA OUT and AF OUT.

③ PTT P

PTT terminal for packet operation only. Connect ground to transmit data.

④ DATA OUT

Data out terminal for 9600 bps operation only.

⑤ AF OUT

Data out terminal for 1200 bps operation only.

⑥ P SQL

Becomes high (+5 V) when the transceiver receives a signal which opens the squelch.

- To avoid unnecessary TNC transmission, connect squelch to the TNC to inhibit transmission when receiving signals.
- Keep audio output at a normal level, otherwise a “P SQL” signal will not be output.

1 PANEL DESCRIPTION

Microphone (HM-133*)

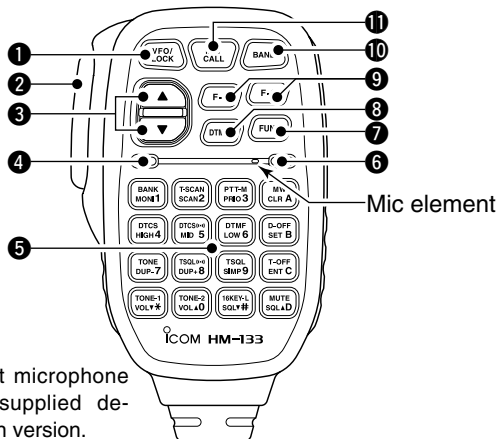

*A different microphone may be supplied depending on version.

1 VFO/LOCK SWITCH [VFO/LOCK]

- ➔ Push to select VFO mode. (p. 12)
- ➔ Push for 1 sec. to switch the lock function ON and OFF. (p. 15)

2 PTT SWITCH

- ➔ Push and hold to transmit; release to receive.
- ➔ Switches between transmitting and receiving while the one-touch PTT function is in use. (p. 21)

3 UP/DOWN SWITCHES [▲]/[▼]

- ➔ Push either switch to change operating frequency, memory channel, set mode setting, etc. (pgs. 13, 28, 55)
- ➔ Push either switch for 1 sec. to start scanning. (p. 40)

4 ACTIVITY INDICATOR

- ➔ Lights red while any key, except [FUNC] and [DTMF-S], is pushed, or while transmitting.
- ➔ Lights green while the one-touch PTT function is in use.

5 KEYPAD (pgs. 8, 9)

6 FUNCTION INDICATOR

- ➔ Lights orange while [FUNC] is activated—indicates the secondary function of switches can be accessed.
- ➔ Lights green when [DTMF-S] is activated—DTMF signals can be transmitted with the keypad.

7 2nd FUNCTION SWITCH [FUNC]

8 DTMF SELECT SWITCH [DTMF-S] (p. 48)

9 FUNCTION SWITCHES [F-1]/[F-2] (p. 64)

- Program and recall your desired transceiver conditions.

10 BAND SWITCH [BAND] (p. 11)

- Push to switches main band between left and right bands.













11 MEMORY/CALL SWITCH [MR/CALL]

- ➔ Push to select memory mode. (p. 12)
- ➔ Push for 1 sec. to select call channel. (p. 37)









✓ Important!

All keys on the microphone function for the main band only.

■ Microphone keypad

KEY	FUNCTION	SECONDARY FUNCTION ( +key)	OTHER FUNCTIONS
	Switches between opening and closing the squelch. (p. 16)	In VFO mode enters operating band selecting condition. (p. 12) In memory mode enters bank selecting condition. (p. 34)	After pushing  : Transmits the appropriate DTMF code. (pgs. 26, 50) When the DTMF memory encoder is activated, push [0] to [9] to transmit the appropriate DTMF memory contents . (p. 49)
	Starts and stops scanning. (p. 40)	Starts and stops tone scanning. (p. 54)	
	Starts and stops priority watch. (p. 46)	Turns the one-touch PTT function ON and OFF. (p. 21)	
	Selects high output power. (p. 20)	Turns the DTCS squelch ON. (p. 52)	
	Selects mid. output power. (p. 20)	Turns the DTCS pocket beep function ON. (p. 52)	
	Selects low output power (p. 20)	Turns the DTMF memory encoder function ON. (p. 48)	
	Selects minus duplex operation. (p. 24)	Turns the subaudible tone encoder ON. (p. 24)	
	Selects plus duplex operation. (p. 24)	Turns the CTCSS pocket beep function ON. (p. 52)	
	Selects simplex operation. (p. 24)	Turns the tone squelch function ON. (p. 52)	
	Increases audio output level. (p. 16)	Sends a 1750 Hz tone signal while pushing and holding. (p. 26)	

1 PANEL DESCRIPTION

KEY	FUNCTION	SECONDARY FUNCTION ( +key)	OTHER FUNCTIONS
	<ul style="list-style-type: none"> ➤ Cancels frequency entry. (p. 13) ➤ Cancels the scan or priority watch. (pgs. 40, 46) ➤ Exit set mode. (p. 55) 	<ul style="list-style-type: none"> ➤ Selects a memory channel for programming. (p. 30) ➤ Advances the memory channel number when continuously pushed after programming is completed. (p. 30) 	After pushing  : Transmits the appropriate DTMF code. (pgs. 26, 50)
	<ul style="list-style-type: none"> ➤ Enters set mode (p. 55) ➤ Advances the set mode selection order after entering set mode. (p. 55) 	DTMF memory encoder function OFF. (p. 49)	
	<ul style="list-style-type: none"> ➤ Sets the keypad for numeral input. (p. 13) ➤ Reverses the set mode selection order after entering set mode. (p. 55) 	Turns the subaudible tone encoder, pocket beep or CTCSS/DTCS tone squelch OFF. (pgs. 24, 52)	
	Adjusts the squelch level increments. (p. 16)	Mutes the audio. (p. 21) • Mute function is released when any operation is performed.	
	Decreases audio output level. (p. 16)	Sends a 1750 Hz tone signal for 0.5 sec. (p. 26)	
	Adjusts the squelch level decrement. (p. 16)	Locks the digit keys on the keypad (including the A to D, # and * keys. (p. 15)	

■ Optional Microphones (HM-118N/TN)

• HM-118N

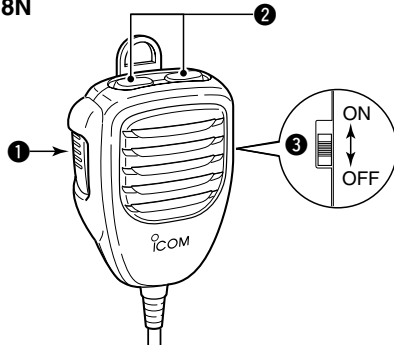

• HM-118TN
(DTMF)

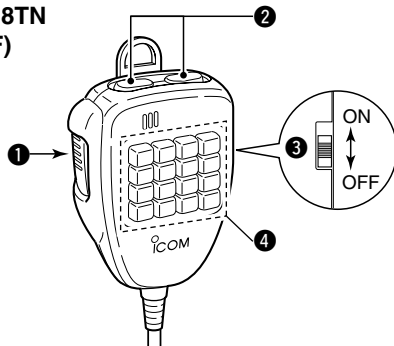

1 PTT SWITCH

➤ Push and hold to transmit; release to receive.

2 UP/DOWN SWITCHES [UP]/[DN]

- Push either switch to change operating frequency, memory channel, set mode setting, etc.
- Push either switch for 1 sec. to start scanning.

3 UP/DN LOCK SWITCH

Slide to toggle [UP]/[DN] switches function ON and OFF.

4 KEYPAD (HM-118TN only)

While pushing [PTT], push the desired key to send the DTMF code.

■ Preparation

◇ Turning power ON/OFF

Push [PWR] for 1 sec.

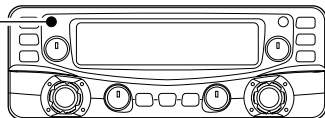

➔ Push [PWR] for 1 sec. to turn power ON and OFF.

◇ MAIN band

The IC-2725E can receive 2 m and 70 cm band signals simultaneously. To activate all functions access or to change frequency via the microphone, you must designate one band as the main band. The transceiver transmits a signal on the main band only.

Push the desired band's [MAIN•BAND]

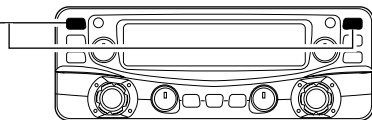

➔ Push the desired band's [MAIN•BAND] to select the main band.

- "MAIN" indicates the main band.



➔ Push [BAND] to toggle the main band between left and right bands.

◇ Operating frequency band selection

In the default condition, or after resetting the CPU, 2 m band is assigned in the left band, 70 cm band is assigned in the right band. However, the 2 m band can also be assigned into the right, and 70 cm band can also be assigned into the left band.

Push the desired band's [MAIN•BAND] for 1 sec.

[DIAL]

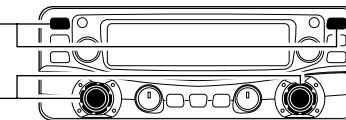

Frequency band initial is displayed.

- ① Push the desired band's [MAIN•BAND] for 1 sec.
 - Frequency band initial appears.
- ② Rotate the same band's [DIAL] to select the desired frequency band.
 - Pushing [▲]/[▼] on the microphone also selects the band.
- ③ Push the [MAIN•BAND] to return to frequency indication in the selected frequency band.



Note that in this manual, sections beginning with a microphone icon (as at left), designate operation via the HM-133 microphone.



- 1 Push [BAND] to select main band.
- 2 Push [FUNC], the push [BANK 1(MONI)] to select frequency band selecting condition.
 - The frequency band initial is displayed.
- 3 Push [▲]/[▼] to select the desired frequency band.
- 4 Push [CLR A(MW)] to exit the condition, and return to frequency indication.



◇ VFO and memory modes

The transceiver has 2 basic operating modes: VFO mode and memory mode. Select VFO mode first to set an operating frequency.

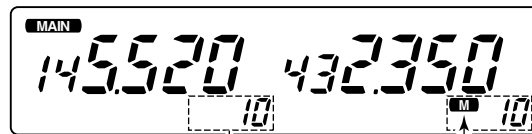
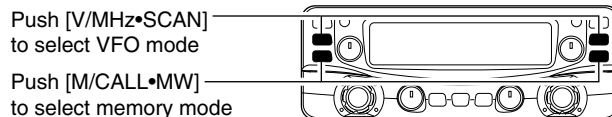

VFO mode is selected “M” indicator appears when memory mode is selected

- ➔ Push the desired band’s [V/MHz•SCAN] to select VFO mode.
 - When VFO mode is already selected, the digit below 10 MHz (the digit below 1 MHz or 100 kHz disappear depending on versions) disappear. In this case, push [V/MHz•SCAN] again (or twice or 3 times depending on version).
- ➔ Push [M/CALL•MW] to select memory mode.
 - “M” indicator appears when memory mode is selected.



- ➔ Push [VFO/LOCK] to select VFO mode.
- ➔ Push [MR/CALL] to select memory mode.
 - The microphone controls the main band only. Push [BAND] to toggle the main band, then push [VFO/LOCK] or [MR/CALL], if necessary.

2 SETTING A FREQUENCY

■ Using the tuning dial

- ① Rotate the desired band's [DIAL] to set the frequency.
 - If VFO mode is not selected, push the same band's [V/MHz•SCAN] to select VFO mode.
 - The frequency changes in the selected tuning steps. (p. 14)

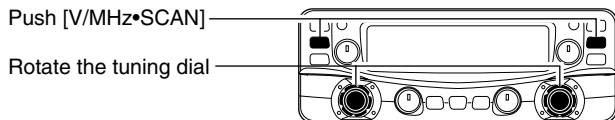

- ② To change the frequency in 1 MHz (10 MHz for some versions) steps, push [V/MHz•SCAN], then rotate [DIAL].
 - Pushing [V/MHz•SCAN] for 1 sec. starts scan function. If scan starts, push [V/MHz•SCAN] again to cancel it.

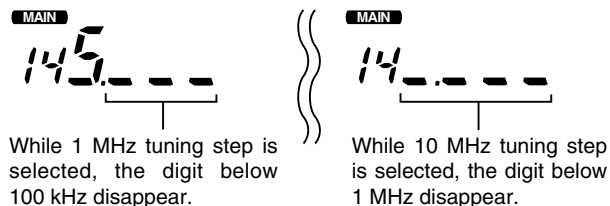

■ Using the [▲]/[▼] keys



- ➔ Push [▲] or [▼] to select the desired frequency.
- Push [BAND] to select the desired band (left or right) as the main band in advance.
- Pushing [▲]/[▼] for 1 sec. activates a scan. If scan starts, push [▲]/[▼] or [CLR A(MW)] to cancel it.

■ Using the keypad

The frequency can be directly set via numeral keys on the microphone.



- ① Push [BAND] to select the desired band (left or right) as the main band.
 - Push [VFO/LOCK] to select VFO mode, if necessary.
- ② Push [ENT C(T-OFF)] to activate the keypad for digit input.
- ③ Push 6 keys to input a frequency.
 - When a digit is mistakenly input, push [ENT C(T-OFF)] to clear the input, then repeat input from the 1st digit.
 - Pushing [CLR A(MW)] clears input digits and retrieves the frequency.

[EXAMPLE]: Setting frequency to 145.3625 MHz.

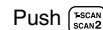

■ Tuning step selection

USING SET MODE

Tuning steps are the minimum frequency change increments when you rotate [DIAL] or push [▲]/[▼] on the microphone. Independent tuning step for the left and right, as well as each frequency bands can be set for individual tuning convenience. The following tuning steps are available.

- 5 kHz • 10 kHz • 12.5 kHz • 15 kHz
- 20 kHz • 25 kHz • 30 kHz • 50 kHz

NOTE: For convenience, select a tuning step that matches the frequency intervals of repeaters in your area.

- ① Push the desired band's [MAIN•BAND] to select the main band.
 - Push the same band's [V/MHz•SCAN] to select VFO mode, if necessary.

- ② Push [SET•

Push [SET•

[LOW•PRIO]

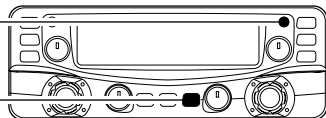

- ③ Push [SET•

- ④ Rotate the same band's [DIAL] to select the desired tuning step.
- ⑤ Push [TONE•DTMF] to exit set mode.



- ① Push [BAND] to select the desired band (left or right) as the main band.
 - Push [VFO/LOCK] to VFO mode, if necessary.
- ② Push [SET B(D-OFF)] to enter set mode.
- ③ Push [SET B(D-OFF)] or [ENT C(T-OFF)] several times until “tS” appears.
- ④ Push [▲] or [▼] to select the desired tuning step.
- ⑤ Push [CLR A(MW)] to exit set mode.

2 SETTING A FREQUENCY

■ Lock functions

To prevent accidental frequency changes and unnecessary function access, use the lock function. The transceiver has 2 different lock functions.

◇ Frequency lock

This function locks [DIAL] and switches electronically and can be used together with the microphone lock function.

Push [SET•] for 1 sec.

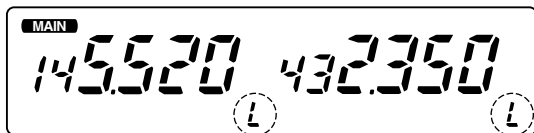
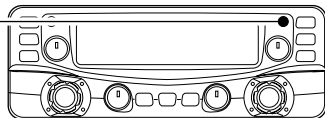

2 "L"s appear while the lock function is activated.

➔ Push [SET•] for 1 sec. to turn the lock function ON and OFF.

- [PTT], [DUP•MONI] (monitor function only), [VOL], [SQL] and [MAIN•BAND] (main band selection only) can be used while the channel lock function is in use. Also, TONE-1, TONE-2, DTMF tones or DTMF memory contents can be transmitted from the microphone.



➔ Push [VFO/LOCK] for 1 sec. to switch the lock function ON and OFF.

◇ Microphone keypad lock

This function locks the microphone keypad.



➔ Push [FUNC] then [SQL▼D(16KEY-L)] to switch the microphone keypad lock function ON and OFF.

- [PTT], [VFO/LOCK], [MR/CALL], [BAND], [▲], [▼], [F-1], [F-2], [DTMF-S] and [FUNC] on the microphone can be used.
- All switches on the transceiver can be used.
- The keypad lock function is released when the power is turned OFF then ON again.

■ Receiving

- ① Set the audio level for the main band.
 - ➔ Push the desired band's [MAIN•BAND].
 - ➔ Push [DUP•MONI] for 1 sec. to open the squelch.
 - ➔ Rotate the main band's [VOL] to adjust the audio level.
 - ➔ Push the [DUP•MONI] for 1 sec. to close the squelch.
- ② Set the squelch level.
 - ➔ Rotate the main band's [SQL] fully counterclockwise in advance, then rotate the [SQL] clockwise until the noise just disappears.
 - When interference is received, rotate the [SQL] clockwise again for attenuator operation. (p. 17)
- ③ Set the operating frequency in main band. (pgs. 11–13)
- ④ When receiving a signal on the set frequency, squelch opens and the transceiver emits audio.



Appears when receiving a signal.

- “BUSY” appears and the S/Rf indicator shows the relative signal strength for the received signal.

✓CONVENIENT!



The main band's audio and squelch level can also be adjusted with [VOL▲(TONE-1)]/[VOL▼0(TONE-2)] and [SQL▲D(MUTE)]/[SQL▼#(16KEY-L)], respectively.

- “VOL” for audio or “SQL” for squelch appears during set.



■ Monitor function

This function is used to listen to weak signals without disturbing the squelch setting.

Push [DUP•MONI] for 1 sec.

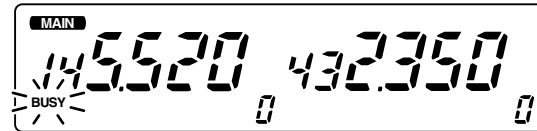
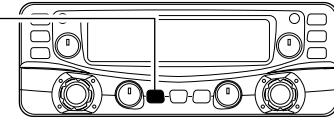

- ➔ Push [DUP•MONI] for 1 sec. to open the squelch.
 - Push [MIN•BAND] to select the desired band (left or right) as the main band in advance.
 - “BUSY” blinks.
 - Push [DUP•MONI] for 1 sec. again to cancel the function.



- ➔ Push [MONI 1(BANK)] to open the squelch.
 - Push [BAND] to select the desired band (left or right) as the main band in advance.
 - Push [MONI 1(BANK)] again to cancel the function.

NOTE: When [SQL] is set to too far clockwise position, 12 to 17 hours, the squelch attenuator may be functioning, even while monitoring. To monitor weak signals on the operating frequency, deactivate the squelch attenuator function. See p. 17 for details.

3 BASIC OPERATION

■ Squelch attenuator

The transceiver has an RF attenuator related to the squelch level setting. Approx. 10 dB attenuation is obtained at maximum setting.

The squelch attenuator allows you to set a minimum signal level needed to open the squelch. The attenuator function can be deactivated in initial set mode.

- ▶ Rotate [SQL] clockwise past the 12 o'clock position to activate the squelch attenuator.
 - Attenuation level can be adjusted up to 10 dB (approx.) between 12 o'clock and fully clockwise position.
 - When setting the squelch from the microphone, a level greater than '19' activates the squelch attenuator.

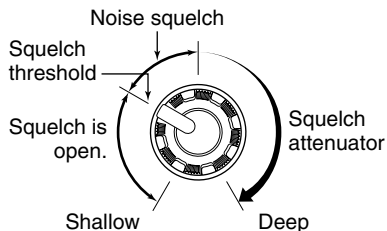

NOTE: The squelch attenuator functions even when the monitor function is in use. Thus set the [SQL] control within 10 to 12 o'clock position is recommended when using the monitor function.

◇ Squelch attenuator setting

USING INITIAL SET MODE

- ① Turn the transceiver power OFF.
- ② While pushing [SET•], turn the power ON to enter initial set mode.

While pushing [SET•] push [PWR] to enter initial set mode

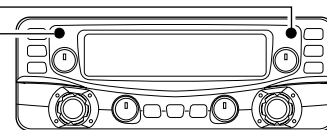

- ③ Push [SET•] or [LOW•PRIO] to select "Att-On" (squelch attenuator) item.
- ④ Rotate the left band's [DIAL] to toggle the function ON and OFF.
 - Select "OF" to deactivate the squelch attenuator function.



- ⑤ Push [PWR] to exit initial set mode.

■ V/V, U/U simultaneous receive (Para-watch)

The IC-2725E can simultaneously receive two signals on the same band, such as 144 MHz band, using the para-watch function.

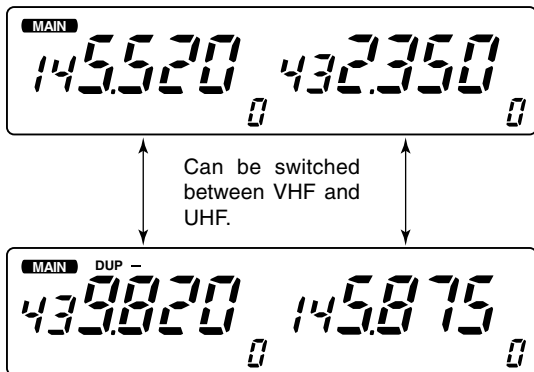

[Example]

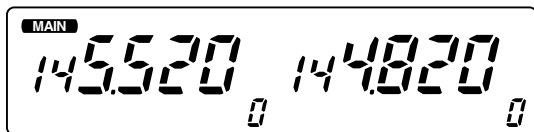

- ① Push either the left or right band's [MAIN•BAND] for 1 sec. to select the frequency band selecting condition.
- ② Rotate the same band's [DIAL] to select the desired frequency band.
- ③ Push the [MAIN•BAND] to return to frequency indication.
- ④ Set the desired frequency.
- ⑤ Repeat the steps ① to ④ for the other band (left or right).

To activate the para-watch function from the HM-133, enter the desired frequencies for each the left and right bands using the direct frequency input capability via the keypad; or perform the following operation.



- ① Push [FUNC], the push [BANK 1(MONI)] to select frequency band selecting condition.
 - The frequency band initial appears on the main band.

- ② Push [▲]/[▼] to select the desired frequency band band.



- ③ Push [CLR A(MW)] to exit the condition, and return to frequency indication.

- ④ Push [VFO/LOCK] to change main band, then repeat the steps ① to ③ for the other band.

NOTE:

- Memory channels are common for the left and right band.
- Transmitting during the para-watch operation is possible. However, the sub band's reception is deactivated during transmit.

3 BASIC OPERATION

■ Sub band mute/sub band busy beep

USING INITIAL SET MODE

The sub band mute function automatically cuts out sub band audio signals when both main and sub band signals are received simultaneously.

While operating on the main band, a beep sounds to inform you that a signal was received on the sub band.

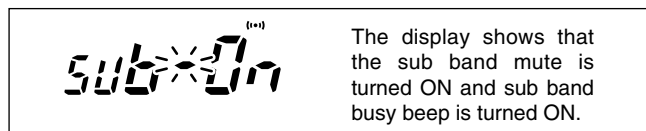

- ① While pushing [SET•>], push [PWR] for 1 sec. to enter initial set mode.

While pushing [SET•>] push [PWR] to enter initial set mode

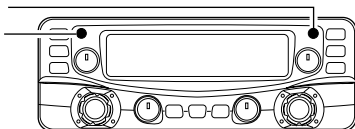

- ② Push [SET•>] or [LOW•PRIO] until "SUB" appears in the display as shown above.

- ③ Rotate the left band's [DIAL] to select the condition.

DISPLAY	SUB BAND MUTE	BUSY BEEP
SU _b -OF	OFF	OFF
SU _b -OF ((•))	OFF	ON
SU _b -On	ON	OFF
SU _b -On ((•))	ON	ON

- ④ Push [PWR] momentarily, to exit initial set mode and return to the previous indications.

■ Transmitting

CAUTION: Transmitting without an antenna will damage the transceiver.

NOTE: To prevent interference, listen on the channel before transmitting by pushing [DUP•MONI] for 1 sec., or [MONI 1(BANK)] on the microphone.

- ① Select the main band. (p. 11)
- ② Set the operating frequency. (pgs. 11–13)
 - Select output power if desired. See section at right for details.
- ③ Push and hold [PTT] to transmit.
 - “TX” appears.
 - The S/R/F indicator shows the output power selection.
 - A one-touch PTT function is available. See p. 21 for details.
 - “Si” may blink instead of the sub band’s memory channel number indication according to the selected frequency band.
- ④ Speak into the microphone using your normal voice level.
 - DO NOT hold the microphone too close to your mouth or speak too loudly. This may distort the signal.
- ⑤ Release [PTT] to return to receive.

IMPORTANT! (for 50/35 W transmission):
 The IC-2725E is equipped with protection circuit to protect the power amplifier circuit from high SWR (Standing Wave Ratio) and temperature. When a high SWR antenna or no antenna is connected, or when the transceiver temperature becomes extremely high, the transceiver reduces transmit output power to 15 W (approx.) automatically.

■ Selecting output power

The transceiver has 3 output power levels to suit your operating requirements. Low output powers during short-distance communications may reduce the possibility of interference to other stations and will reduce current consumption.

➔ Push [LOW•PRIO] once or twice to select the output power.

S/R/F INDICATOR	POWER OUTPUT VHF/UHF
High:	50 W/35 W
Mid:	15 W*/15 W*
Low:	5 W*/5 W*

*approx.

• The output power can be changed while transmitting.

The microphone can also be used to select output power.

- ➔ Push [HIGH 4(DTCS)] for high output power; [MID 5(DTCS ((••)))] for middle output power; and [LOW 6(DTMF)] for low output power.
- The output power can be changed via the microphone during receive only.



3 BASIC OPERATION

■ One-touch PTT function

The PTT switch can be operated as a one-touch PTT switch (each push toggles between transmit/receive). Using this function you can transmit without pushing and holding the PTT switch.

To prevent accidental, continuous transmissions with this function, the transceiver has a time-out timer. See p. 61 for details.



- 1 Push [FUNC] then [PRIO 3(PTT-M)] to turn the one-touch PTT function ON.
 - The activity indicator lights green.
- 2 Push [PTT] to transmit and push again to receive.
 - A beep sounds when transmission is started and a long beep sounds when returning to receive.
 - “TX” blinks when transmitting with the one-touch PTT function.



TX indicator blinks

- 3 Push [FUNC] then [PRIO 3(PTT-M)] to turn the one-touch PTT function OFF.
 - The activity indicator goes out.

■ Audio mute function

This function temporarily mutes the audio without disturbing the volume setting.



- ➔ Push [FUNC] then [SQL▲ D(MUTE)] to mute audio signals.
 - Both the left and right bands S/RF meter blink in full-scale condition.
 - Push [CLR A(MW)] (or any other key) to cancel the function.

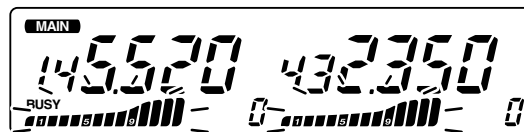

S/RF meter blinks (full-scale).

■ General

Repeaters allow you to extend the operatable range, and also settle blind zone. Because a repeater has much higher output power than the typical transceiver, and installed into a broad view.

Normally, a repeater has independent frequency for each receive and transmit, and a subaudible tone may be required to accessing a repeater.

Refer amateur radio handbook, ham magazine for details of local repeater, such as repeater input/output frequencies and location.

Repeater example;

Receives the 145.950 MHz signal and the detected audio signals are transmitted on 145.30 MHz simultaneously.

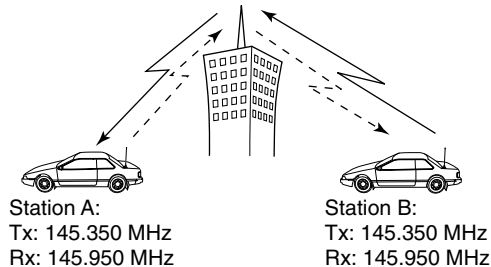

• Repeater operation flow chart

Step 1:

Set the desired band to operate the repeater.

Step 2:

Set the desired receive frequency (repeater output frequency).

Step 3:

Set the duplex (shifting) direction (- duplex or +duplex).
- Set the offset frequency (shifting value), if required.

Step 4:

Set the subaudible tone (repeater tone) encoder function ON.
- Set the subaudible tone frequency, if required.

• Repeater settings can be stored into a memory channel.

4 REPEATER OPERATION

■ Accessing a repeater

- ① Set the receive frequency (repeater output frequency) on the main band. (pgs. 11–13)
- ② Push [DUP•MONI] one or two times, to select minus duplex or plus duplex.
 - “DUP–” or “DUP” appears to indicate the transmit frequency for minus shift or plus shift, respectively.

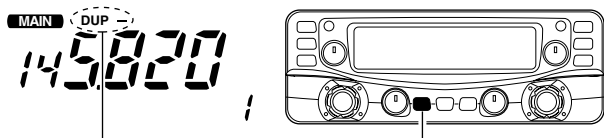

“DUP–” or “DUP” appear Push [DUP•MONI] once or twice

- ③ Push [TONE•DTMF] several times to turn ON the subaudible tone encoder, according to repeater requirements.
 - “T” appears
 - 88.5 Hz is set as the default; refer to p. 25 for tone frequency settings.
 - When the repeater requires a different tone system, see p. 26.

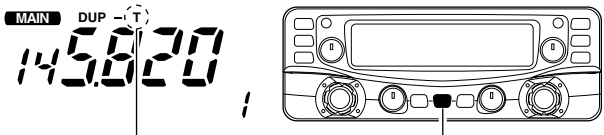

“T” appears Push [TONE•DTMF] once or twice

- ④ Push and hold [PTT] to transmit.
 - The displayed frequency automatically changes to the transmit frequency (repeater input frequency).
 - If “OFF” appears, confirm that the offset frequency (p. 27) is set correctly.
- ⑤ Release [PTT] to receive.

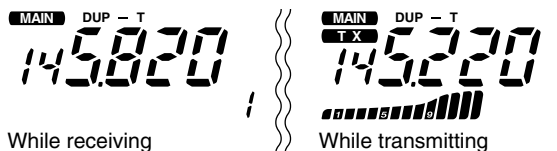

While receiving

While transmitting

- ⑥ Push [DUP•MONI] to check whether the other station's transmit signal can be received directly.
- ⑦ To return to simplex operation, push [DUP•MONI] once or twice, to clear the “DUP–” or “DUP” indicator.
- ⑧ To turn OFF the subaudible tone encoder, push [TONE•DTMF] several times until no tone indicators appear.



- 1 Set the receive frequency (repeater output frequency) on the main band. (pgs. 11–13)
- 2 Push [DUP- 7(TONE)] to select minus duplex; push [DUP+ 8(TSQL (**))] to select plus duplex.

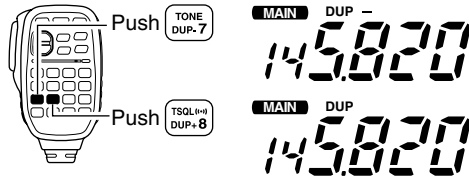

- 3 Push [FUNC] then [DUP- 7(TONE)] to turn ON the subaudible tone encoder according to repeater requirements.
 - Refer to p. 25 for the tone frequency setting.
 - When the repeater requires a different tone system, see p. 26.

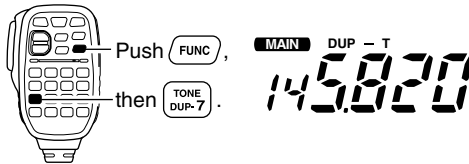

- 4 Push and hold [PTT] to transmit.
- 5 Release [PTT] to receive.
- 6 Push [MONI 1(BANK)] to check whether the other station's transmit signal can be received directly.



- 7 Push [SIMP 9(TSQL)] to return to simplex operation.
 - “DUP” or “DUP-” indicator disappears.
- 8 To turn OFF the subaudible tone encoder, push [FUNC] then [ENT C(T-OFF)].

4 REPEATER OPERATION

■ Subaudible tones USING SET MODE (Encoder function)

◇ Subaudible tones

- ① Select the main band, mode/channel you wish to set the subaudible tones to, such as VFO mode or memory/call channel.
- ② Push [SET•] to enter set mode.
- ③ Push [SET•] or [DUP•MONI] several times until “T” and “rt” appear; or until “T SQL” and “Ct” appear for tone squelch or pocket beep use.
 - When “d” is displayed in place of the 100 MHz digit, cancel the DTMF memory encoder in advance. (p. 49)

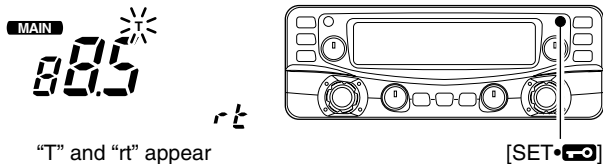

- ④ Rotate the main band’s [DIAL] to select and set the desired subaudible frequency.
- ⑤ Push [TONE•DTMF] to exit set mode.

NOTE: The subaudible tone encoder frequency can be set in a memory/call channel temporarily. However, the set frequency is cleared once another memory channel or VFO mode is selected. To store the tone frequency permanently, overwrite the channel information.



- ① Set the main band, mode/channel you wish to set the subaudible tones to, such as VFO mode or memory/call channel.
 - The subaudible tone frequency is independently programmed into each mode or channel.
- ② Push [SET B(D-OFF)] to enter set mode.
- ③ Push [SET B(D-OFF)] or [ENT C(T-OFF)] several times until “T” and “rt” appears; or until “T SQL” and “Ct” appears for tone squelch or pocket beep use.
 - When “d” is displayed in place of the 100 MHz digit, cancel the DTMF memory encoder in advance. (p. 49)

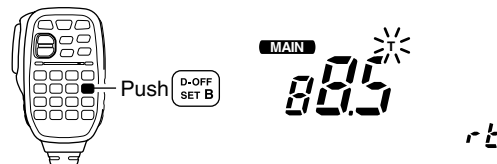

- ④ Push [▲] or [▼] to select and set the desired subaudible tone frequency.
 - Push and hold [▲]/[▼] to change the above tones continuously.
- ⑤ Push [CLR A(MW)] to exit set mode.

• Subaudible tone frequency list (unit: Hz)

67.0	79.7	94.8	110.9	131.8	156.7	171.3	186.2	203.5	229.1
69.3	82.5	97.4	114.8	136.5	159.8	173.8	189.9	206.5	233.6
71.9	85.4	100.0	118.8	141.3	162.2	177.3	192.8	210.7	241.8
74.4	88.5	103.5	123.0	146.2	165.5	179.9	196.6	218.1	250.3
77.0	91.5	107.2	127.3	151.4	167.9	183.5	199.5	225.7	254.1

◇ DTMF tones



➔ Push [DTMF-S], then push the keys of the desired DTMF digits.

- The function indicator lights green.
- 0–9, A–D, * (E) and # (F) are available.
- When “d” is displayed in place of the 100 MHz digit, cancel the DTMF memory encoder in advance. (p. 49)
- Push [DTMF-S] again to return the keypad to normal function control.



Push [DTMF-S],
then push desired keys.

✓ *For your convenient!*

The transceiver has 14 DTMF memory channels for autopatch operation. See p. 47 for details.

◇ 1750 Hz tone

The microphone has 1750 Hz tone capability, used for ring tone when calling, etc.



1 Push [FUNC].

- The function indicator lights orange.

2 Push [* (TONE-1)] to transmit a 1750 Hz tone call signal for 0.5 sec.; push and hold [0 (TONE-2)] to transmit a 1750 Hz tone call signal for an arbitrary period.

- The function indicator goes out automatically.





Push [FUNC],
then [TONE-1 *] or [TONE-2 0].

4 REPEATER OPERATION

■ Offset frequency USING SET MODE

When communicating through a repeater, the transmit frequency is shifted from the receive frequency by an amount determined by the offset frequency.

Independent offset frequency can be set for each operating frequency.

- ① Push [MAIN•BAND] to select the desired band (left or right) as the main band.
 - Push [MAIN•BAND] for 1 sec. then rotate the [DIAL] to select the desired frequency band if necessary.
- ② Select the desired mode/channel you wish to set the offset frequency to, such as VFO mode or memory/channel.
 - The offset frequency can be independently programmed into each mode or channel.
- ③ Push [SET•- ④ Push [SET•

“DUP” and offset frequency appear [LOW•PRIO] [SET•

- ⑤ Rotate the main band's [DIAL] to set the desired offset frequency.
- ⑥ Push [TONE•DTMF] to exit set mode.



- ① Push [BAND] to select the desired band (left or right) as the main band.
 - Enter the desired frequency via the keypad if necessary.
- ② Select the desired mode/channel you wish to set the offset frequency to, such as VFO mode or memory/channel.
 - The offset frequency can be independently programmed into each mode or channel.
- ③ Push [SET B(D-OFF)] to enter set mode.
- ④ Push [SET B(D-OFF)] or [ENT C(T-OFF)] until “DUP” and offset frequency appear.

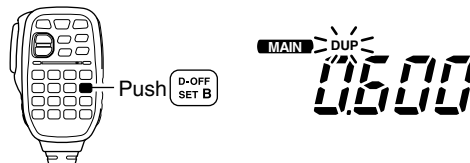

- ⑤ Push [▲] or [▼] to set the desired offset.
 - Direct frequency entry from the keypad is not possible.
- ⑥ Push [CLR A(MW)] to exit set mode.

NOTE: The offset frequency can be set in a memory/channel temporarily. However, the set frequency is cleared once another memory channel or VFO mode is selected. To store the offset frequency permanently, overwrite the channel information.

■ General description

The transceiver has 212 memory channels including 10 scan edge memory channels (5 pairs), and 2 call channels. Each of these channels can be individually programmed with operating frequency (pgs. 11–13), duplex direction (p. 23) and offset (p. 27), subaudible tone encoder or tone squelch and its tone frequency (pgs. 23, 25, 51, 52) and skip information* (p. 44). In addition, a total of 10 memory banks, A to J, are available for usage by group, etc.

*except for scan edge memory channels.

■ Memory channel selection

◇ Using the tuning dial

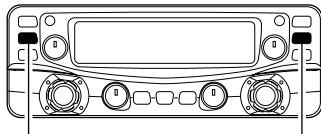

Push [M/CALL•MW] to select memory mode.



- ① Push the desired band's [M/CALL(MW)] several times to select memory mode.
 - “M” indicator appears
- ② Rotate the same band's [DIAL] to select the desired memory channel.
 - Programmed memory channels only can be selected.

◇ Using the [▲]/[▼] keys

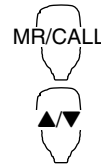

- ① Push [BAND] to select the desired band as the main band.
- ② Push [MR/CALL] to select memory mode.
- ③ Push [▲] or [▼] to select and set the desired memory channel.
 - Pushing [▲]/[▼] for 1 sec. activates a scan.
 - If scan is activated, push [▲]/[▼] again or push [CLR A(MW)] to stop it.

◇ Using the keypad

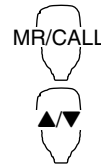

- ① Push [BAND] to select the desired band as the main band.
- ② Push [MR/CALL] to select memory mode.
- ③ Push [ENT C(T-OFF)] to activate the keypad for numeral input.
- ④ Push 3 appropriate digit keys to input a channel number.
 - Blank channel can be selected.
 - Push only 1 appropriate digit key, [MONI 1(BANK)], [SCAN 2(T-SCAN)], [PRIO 3(PTT-M)], [HIGH 4(DTCS)] or [MID 5(DTCS((•)))], then push [* (TONE-1)] or [SQL▼#(16KEY-L)] to select scan edge channels. “*” and “#” can be used for “A” and “b” respectively.

5 MEMORY OPERATION

■ Programming a memory channel

VFO settings, including the set mode contents such as sub-audible tone frequency, offset, can be programmed into a memory channel.

- ① Set the desired frequency in the desired band (left or right).
 - ➔ Push the desired band's [V/MHz•SCAN] to select VFO mode.
 - ➔ Set the frequency using the same band's [DIAL].
 - ➔ Set other data (e.g. tone frequency, duplex information, etc.) if required.
- ② Push the same band's [M/CALL•MW] for 1 sec.
 - 3 beeps sound
 - "M" indicator and the memory channel number blink.

- ③ Rotate the [DIAL] to select the memory channel to be programmed.
 - Memory channels not yet programmed are blank.
- ④ Push the [M/CALL•MW] for 1 sec. to program.
 - 3 beeps sound
 - Memory channel number automatically increases when continuing to push [M/CALL•MW] after programming.

✓ CONVENIENT

Memory programming can be performed in versatile ways e.g. memory channel to the same (or different) memory channel, memory channel to the call channel, etc.

[EXAMPLE]: Programming 145.870 MHz into memory channel 20 (blank channel) via the controller.

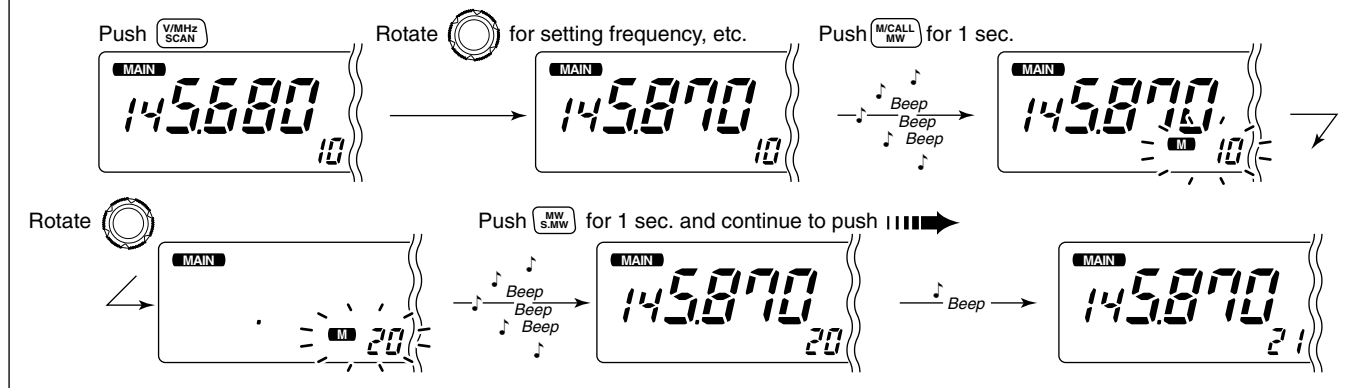

◇ Programming a memory channel via the microphone

 The microphone can also be used to program memory channels.

- 1 Set the desired frequency in VFO mode.
 - ➔ Push [VFO/LOCK] to select VFO mode.
 - ➔ Set the frequency using the keypad.
 - ➔ Set other data (e.g. offset frequency, duplex direction, sub-audible tone encoder ON/OFF and its frequency), if necessary.
- 2 Push [FUNC] then [CLR A(MW)] momentarily.
- 3 Push [▲] or [▼] to select the memory channel.
 - Direct numeral input cannot be used.
- 4 Push [FUNC] then [CLR A(MW)] for 1 sec. to program.
 - ➔ 3 beeps may sound and the VFO contents (including the subaudible tone frequency, etc.) are programmed.
 - ➔ Memory channel number increases when continuing to push [CLR A(MW)] after programming.

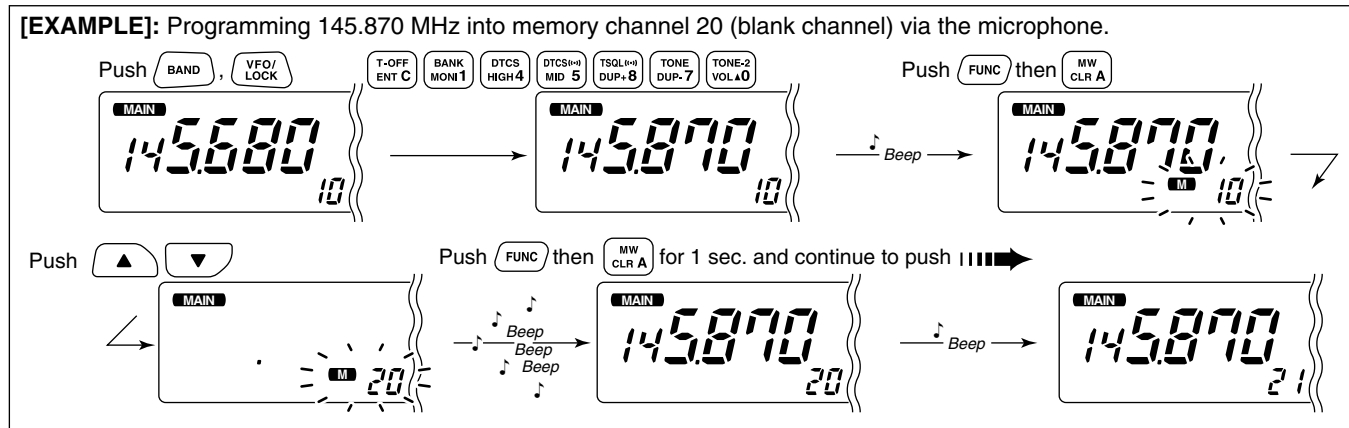

5 MEMORY OPERATION

■ Transferring memory contents

This function transfers a memory channel's contents to VFO (or another memory/call channel). This is useful when searching for signals around a memory channel frequency and for recalling the offset frequency, subaudible tone frequency etc.

◇ Memory/call → VFO

- ① Select the desired band's (left or right) memory or call channel.
 - ➔ Push the desired band's [M/CALL•MW] several times to select memory mode or call channel, then rotate the same band's [DIAL] to select the desired memory or call channel.
- ② Push [M/CALL•MW] for 1 sec. to transfer the selected memory/call channel contents to the VFO.
 - VFO mode is selected automatically.

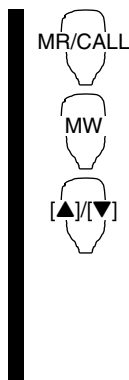

- ① Push [BAND] to select the desired band as the main band, if necessary.
- ② Select the memory/call channel to be transferred.
 - ➔ Push [MR/CALL] to select memory mode, then select the desired memory channel via [▲]/[▼] or keypad.
 - ➔ Push [MR/CALL] for 1 sec. then push [▲]/[▼] to select the call channel.
- ③ Push [FUNC], then [CLR A(MW)] for 1 sec. to transfer the selected memory/call channel contents to the VFO.
 - VFO mode is selected automatically.

[EXAMPLE]: Transferring memory channel 30 contents to VFO.

Front panel operation:

Push to select memory mode. Rotate for selecting memory channel.

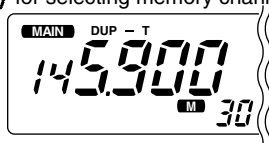
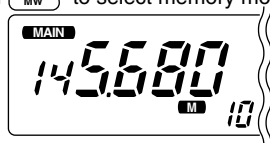

Push for 1 sec.

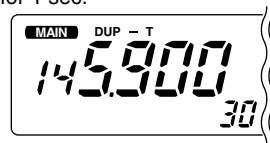

HM-133 operation:

Push to select memory mode.

Select memory channel.

Push then push for 1 sec.

◇ Memory/call↔call/memory

- ① Select the memory/call channel to be transferred.
 - ➔ Push the desired band's [M/CALL•MW] several times to select memory mode or call channel, then rotate the same band's [DIAL] to select the desired memory or call channel.
- ② Push the same band's [M/CALL•MW] for 1 sec.
 - “M” indicator and “--” indication blink, and shows VFO conditions.
- ③ Rotate the [DIAL] to select the target memory channel.
 - “C1” or “C2” blinks when the call channel is selected.
 - Scan edge channels, 1A/1b, 2A/2b, 3A/3b, 4A/4B, 5A/5b can also be selected.
- ④ Push the [M/CALL•MW] for 1 sec. to transfer the selected memory/call channel contents to the target memory.
 - The targeted memory and transferred contents are indicated.



- ① Select the memory/call channel to be transferred.
 - ➔ Push [MR/CALL] to select memory mode, then select the desired memory channel via [▲]/[▼] or keypad.
 - ➔ Push [MR/CALL] for 1 sec. then push [▲]/[▼] to select the desired call channel.
- ② Push [FUNC], then [CLR A(MW)] momentarily.
 - “M” indicator and “--” indication blink, and shows VFO conditions.
- ③ Push [▲]/[▼] to select the target memory channel.
 - “C1” or “C2” blinks when the call channel is selected.
 - Scan edge channels can also be selected.
 - The keypad cannot be used for the selection.
- ④ Push [FUNC] then push [CLR A(MW)] for 1 sec. to transfer the selected memory/call channel contents to the target memory.
 - The targeted memory and transferred contents are indicated.

[EXAMPLE]: Transferring memory channel 30 contents to channel 31.

Front panel operation:

Select the memory channel, then push for 1sec. Select the target channel.

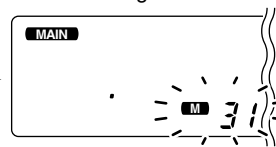

Push for 1 sec.

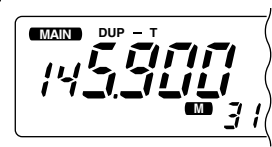

HM-133 operation:

Select the memory channel, push then push .

Push then push for 1 sec.

5 MEMORY OPERATION

Memory clearing

Contents of programmed memories can be cleared (blanked), if desired.

- 1 Push [V/MHz•SCAN] to select VFO mode in the desired band (left or right).
- 2 Push the same band's [M/CALL•MW] for 1 sec.
 - "M" indicator and the memory channel number blink.
- 3 Rotate the same band's [DIAL] to select the memory channel to be cleared.
 - Memory channels not yet programmed are blank.

- 4 Push the same band's [M/CALL•MW] momentarily, then push the [M/CALL•MW] again for 1 sec.
 - **This operation must be performed within 1.5 sec.**
 - 3 beeps sound, then the frequency is cleared.
 - "M" indicator and the channel number blink continuously.
 - When clearing the call channel, the current VFO conditions are re-programmed into the call channel automatically.
- 5 Push the same band's [MAIN•BAND] or [V/MHz•SCAN], to return to VFO mode.

NOTE: Be careful!— the contents of cleared memories CANNOT be recalled.

[EXAMPLE]: Clearing memory channel 20.

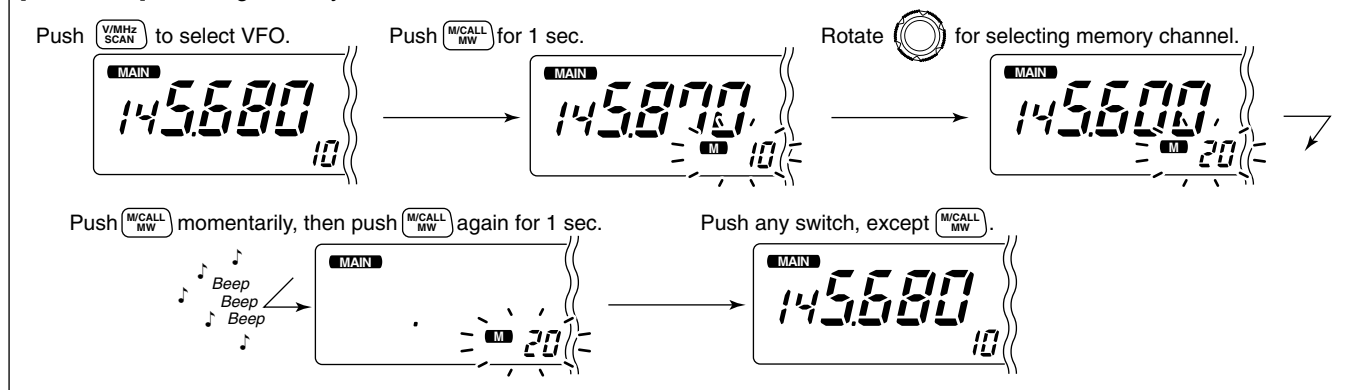

■ Memory bank selection

The IC-2725E has a total of 10 banks (A to J). Regular memory channels, 000 to 199, are assigned into the desired bank for easy memory management.

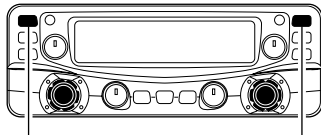

Push [MAIN•BAND] for 1 sec. to select memory bank.



Bank initial appears

- ① Push the desired band's [M/CALL•MW] several times to select memory mode, if desired.
- ② Push the same band's [MAIN•BAND] for 1 sec. to select memory bank condition.
 - Bank initial blinks
- ③ Rotate the same band's [DIAL] to select the desired bank, A to J.
 - Banks that have no programmed contents are skipped.
- ④ Push the [MAIN•BAND] to set the bank.
 - Initial stops blinking.
- ⑤ Rotate the [DIAL] to select the contents in the bank.
 - No channel numbers are displayed for memory bank operation.
- ⑥ To return to regular memory condition, push the [MAIN•BAND] for 1 sec. then push the [MAIN•BAND] momentarily again.



- ① Push [MR/CALL] to select memory mode, if desired.
- ② Push [FUNC] then [MONI 1(BANK)] to select memory bank condition.
 - Bank initial blinks
- ③ Push [▲]/[▼] to select the desired bank, A to J.
 - Only programmed memory bank can be selected.
- ④ Push [CLR A(MW)] to set the bank.
 - Initial stops blinking.
- ⑤ Push [▲]/[▼] to select the desired contents in the bank.
 - No channel numbers are displayed for memory bank operation.
- ⑥ To return to regular memory condition, push [FUNC], [MONI 1(BANK)] then push [CLR A(MW)].

5 MEMORY OPERATION

■ Memory bank setting

- ① Push the desired band's [M/CALL•MW] several times to select memory mode, then select the desired memory channel via the same band's [DIAL].
- ② Push the same band's [MAIN•BAND] for 1 sec.
 - “- -” indication blinks as follows.

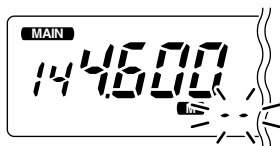

- ③ Push the [MAIN•BAND] again to set the channel to bank setting stand-by condition.
 - “- -” indication blinking stops.
- ④ Push the [M/CALL•MW] for 1 sec. then rotate the [DIAL] to select the desired bank to be set.
 - Bank initial blinks as follows.

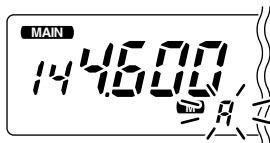

- ⑤ Push the [M/CALL•MW] again to set the channel into the bank.
 - “**M**” and bank initial blinking stops.

- ⑥ Push the [MAIN•BAND] for 1 sec. then push the [MAIN•BAND] momentarily again to return to regular memory condition.
- ⑦ Repeat steps ① to ⑥ to set another memory channel into the same or another bank.

BANK

MW

[▲]/[▼]

- ① Push [MR/CALL] then select the desired memory channel via [▲]/[▼] or keypad.
 - Push [BAND] to select the desired band (left or right) as the main band, in advance.
- ② Push [FUNC] then [MONI 1(BANK)].
 - “- -” indication blinks.
- ③ Push [CLR A(MW)] to set the channel to bank setting stand-by condition.
 - “- -” indication stops blinking.
- ④ Push [FUNC] then [CLR A(MW)] then push [▲]/[▼] to select the desired bank to be set.
 - Bank initial blinks.
- ⑤ Push [CLR A(MW)] to set the channel into the bank.
 - “**M**” and bank initial stops blinking.
- ⑥ Push [FUNC], [MONI 1(BANK)] then [CLR A(MW)] to return to regular memory channel condition.
- ⑦ Repeat steps ① to ⑥ to set an another memory channel into the same or another bank.

■ Transferring bank contents

Contents of programmed memory banks can be cleared or transferred to another bank.

/// INFORMATION: Even if the memory bank contents are cleared, the memory channel contents still remain programmed.

- ① Select the desired bank contents to be transferred or erased in the desired band (left or right).
 - ➔ Push the desired band's [M/CALL•MW] several times to select memory mode.
 - ➔ Push the same band's [MAIN•BAND] for 1 sec. then rotate the same band's [DIAL] to select the desired memory bank.
 - Bank initial blinks.
 - ➔ Push the [MAIN•BAND] to select the bank then rotate the [DIAL] to select the desired contents.
 - Bank initial stops blinking.
- ② Push the [M/CALL•MW] for 1 sec.
 - Bank initial blinks.

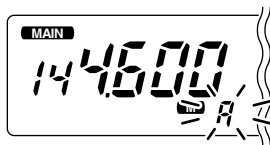

- ③ Rotate the [DIAL] to select the desired bank initial to transfer or erase.
 - Select “- -” indication when erasing the contents from the bank.

- ④ Push the [M/CALL•MW] again.
 - Bank initial or “- -” indication stops blinking.
- ⑤ Push the [MAIN•BAND] for 1 sec. then push the [MAIN•BAND] momentarily again to return to regular memory condition.
- ⑥ Repeat steps ① to ⑤ for transferring or erasing an another banks contents.



- ① Select the desired bank contents in the main band.
 - ➔ Push [MR/CALL] to select memory mode.
 - ➔ Push [FUNC], [MONI 1(BANK)] then select the desired memory bank via [▲]/[▼].
 - ➔ Push [CLR A(MW)] to select the bank then select the desired contents via [▲]/[▼].
- ② Push [FUNC] then [CLR A(MW)].
 - Bank initial blinks.
- ③ Push [▲]/[▼] to select the desired bank initial to transfer or erase.
 - Select “- -” indication when erasing the contents from the bank.
- ④ Push [CLR A(MW)].
 - Bank initial or “- -” indication stops blinking.
- ⑤ Push [FUNC], [MONI 1(BANK)] then [CLR A(MW)] to return to regular memory condition.
- ⑥ Repeat steps ① to ⑤ for transferring or erasing an another banks contents.

6

CALL CHANNEL OPERATION

Call channel selection

Call channel is pre-programmed memory channel that can be accessed by simply pushing call channel button.

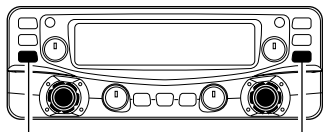

Push [M/CALL•MW] several times to select call channel.

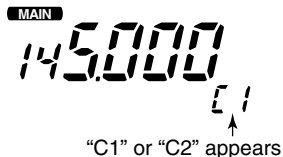

- ➔ Push [MR/CALL] for 1 sec. to select the call channel mode then push [▲]/[▼] to select the desired call channel in the main band.
- Push [MR/CALL] to select memory mode, or push [VFO/LOCK] to select VFO mode.

- ➔ Push [M/CALL•MW] several times to select the call channel mode then rotate the same band's [DIAL] to select the desired call channel.
- "C1" or "C2" appears instead of memory channel number indication.
- Push the [M/CALL•MW] several times to select memory mode, or push the same band's [V/MHz•SCAN] to select VFO mode.

✓ INFORMATION



When the VFO mode is selected from the call channel, a small "c" appears instead of memory channel number.

Call channel transferring

- ① Push the desired band's [M/CALL•MW] several times then rotate the same band's [DIAL] to select the desired call channel.
 - "C1" or "C2" appears.
- ② Push the [M/CALL•MW] for 1 sec., then rotate the [DIAL] to select the memory channel to transfer the contents to.
 - "M" indicator and memory channel number blink.
 - To transfer to the VFO, select "--" with the [DIAL] then push the [M/CALL•MW] for 1 sec.
- ③ Push the [M/CALL•MW] for 1 sec. to transfer the contents.



- ① Push [MR/CALL] for 1 sec. then push [▲]/[▼] to select the desired call channel in the main band.
- ② Push [FUNC], [CLR A(MW)] momentarily, then push [▲]/[▼] to select the memory channel to transfer the contents to.
 - To transfer to the VFO, push [▲]/[▼] to select "--" then push [FUNC], [CLR A(MW)] for 1 sec.
- ③ Push [FUNC], then [CLR A(MW)] for 1 sec. to transfer the contents.

■ Programming a call channel

Operating frequency, duplex information, subaudible tone information (tone encoder or tone squelch ON/OFF and its frequency) and alphanumeric channel names can also be programmed into the call channel.

- ① Set the desired frequency in VFO mode.
 - ➔ Push the desired band's [V/MHz•SCAN] to select VFO mode.
 - ➔ Set the frequency using the same band's [DIAL].
 - ➔ Set other data as desired.
- ② Push the same band's [M/CALL•MW] for 1 sec.
- ③ Rotate the [DIAL] to select the desired call channel.
 - “[M]” indicator and “C1” or “C2” blink.

- ④ Push the [M/CALL•MW] for 1 sec. to program.
 - 3 beeps sound and the unit returns to VFO mode automatically.

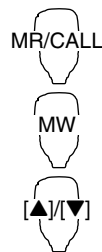

- ① Set the desired frequency in VFO mode.
 - ➔ Push [VFO/LOCK] to select VFO mode.
 - ➔ Set the frequency.
 - ➔ Set other data as desired.
- ② Push [FUNC], then [CLR A(MW)] momentarily.
- ③ Select the call channel via [▲] or [▼].
- ④ Push [FUNC] then [CLR A(MW)] for 1 sec. to program.
 - 3 beeps sound and the unit returns to VFO mode automatically.

6

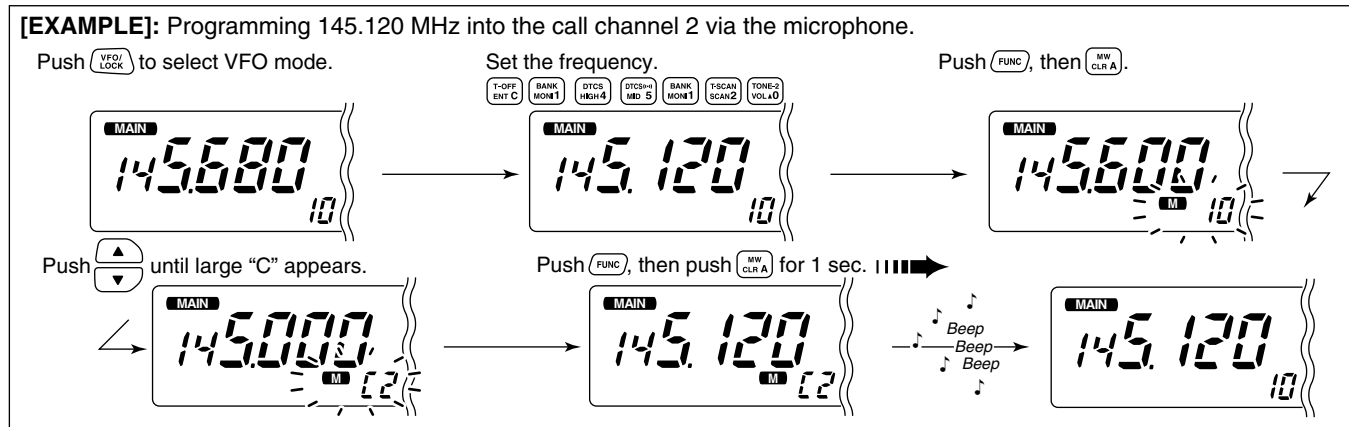

■ Scan types

Scanning searches for signals automatically and makes it easier to locate new stations for contact or listening purposes.

There are 3 scan types and 4 resume conditions to suit your operating needs.

BAND SCAN (p. 40)

Repeatedly scans all frequencies over the entire band. Used as the simplest scan without any preliminary settings necessary.

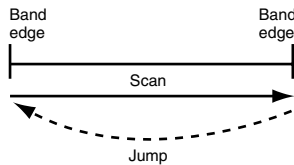

PROGRAMMED SCAN (p. 40)

Repeatedly scans between two user-programmed frequencies. Used for checking for frequencies within a specified range such as repeater output frequencies, etc.

5 pairs of scan edges are available and scans 1A–1b (P1), 2A–2b (P2), 3A–3b (P3), 4A–4b (P4), 5A–5b (P5).

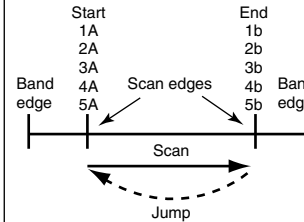

MEMORY SCAN (p. 40)

Repeatedly scans memory channels except those set as skip channels. Used for often-called channels and for bypassing normally busy channels such as repeater frequencies.

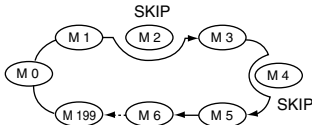

SCAN RESUME CONDITION (p. 44)

4 resume conditions are available: 3 timer scans and pause scan. When receiving a signal, pause scan pauses until the signal disappears; timer scans pause for 5, 10 or 15 sec.

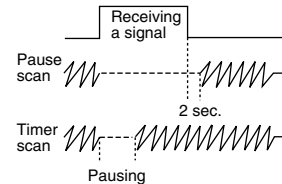

NOTE: A tone scan function is available to search for subaudible tones (e.g. when you want to find a subaudible tone frequency necessary to open a repeater). See p. 54 for details.

■ Scan start/stop

◇ Preparation

Scan resume condition (p. 44); program the scan edges (pgs. 41, 42); program 2 or more memory channels (pgs. 29, 30); set skip settings, if desired (p. 43).

◇ Operation

- ① Select VFO mode for full/programmed scan with [V/MHz•SCAN]; or memory mode for memory scan with [M/CALL•MW] in the desired band.
 - Select the desired bank with the same band's [MAIN•BAND] for bank scan.
- ② Set the squelch to the point where noise is just muted.
- ③ Push the [V/MHz•SCAN] for 1 sec. to start the scan.
 - To change the scanning direction, rotate the same band's [DIAL].
 - The memory channel readout blinks the scan type as follows:
- ④ Push [SET•] to switch full and programmed scan (P1, P2, P3, P4 and P5), if VFO is selected in step ①.
- ⑤ To stop the scan, push the [V/MHz•SCAN].

• During full scan



Push [SET•] to select "AL" (full) or programmed scan (P1, P2, P3, P4 and P5) in sequence.

• During programmed scan



Indicates scan edge channels.

- P1 stands for 1A/1b
- P1 to P5 are available when they are programmed, and switches with [SET•].



- ① Push [VFO/LOCK] to select VFO mode for full/programmed scan; push [MR/CALL] to select memory mode for memory scan, in the main band.
 - Push [FUNC] then [MONI 1(BANK)] to select a bank for bank scan.
- ② Push [SQL▲ D(MUTE)] or [SQL▼ #(16KEY-L)] to set the squelch to the point where noise is just muted.
- ③ Push [SCAN 2(T-SCAN)] to start the scan.
 - Push [▲] or [▼] for 1 sec. also starts the scan.
- ④ Push [SET B(D-OFF)] to switch full and programmed scan (P1, P2, P3, P4 and P5), if VFO is selected in step ①.
- ⑤ To stop the scan push [SCAN 2(T-SCAN)] or [CLR A(MW)].

• During memory scan

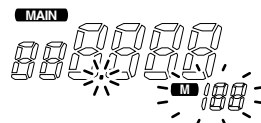

• During bank scan

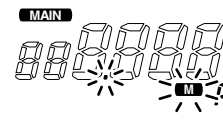

Indicates bank initial.

■ Scan edges programming

Scan edges can be programmed in the same manner as memory channels. Scan edges are programmed into scan edges, 1A/1b to 5A/5b, in memory channels.

- ① Set the edge frequency of the desired frequency range in VFO mode:
 - ➔ Set the frequency using the desired band's [DIAL].
 - ➔ Set other data (e.g. repeater settings, etc.) if desired.
- ② Push the same band's [M/CALL•MW] for 1 sec.
 - “M” indicator and channel number blink.
- ③ Rotate the [DIAL] to select one of scan edge channel, 1A, 2A, 3A, 4A or 5A.

- ④ Push the [M/CALL•MW] for 1 sec. to program.
 - 3 beeps sound and VFO is automatically selected.
 - Scan edge 1b, 2b, 3b, 4b or 5b is automatically selected when continuing to push the [M/CALL•MW] after programming.
- ⑤ To program a frequency for the other pair of scan edges, 1b, 2b, 3b, 4b or 5b, repeat steps ① and ④.
 - If the same frequency is programmed into a pair of scan edges, programmed scan will not function.

[EXAMPLE]: Programming 145.300 MHz into scan edges 1A.

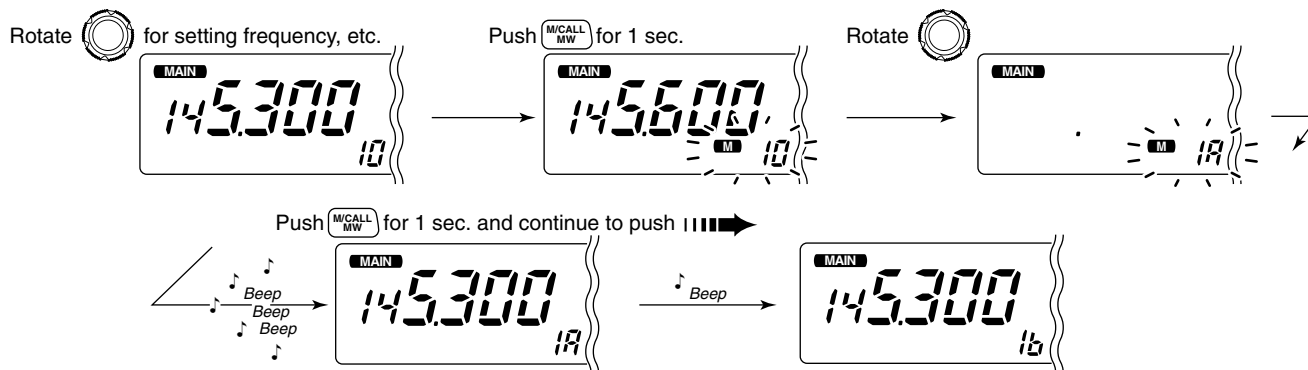

◇ Programming scan edges via microphone



- 1 Set the desired frequency in VFO mode.
 ➔ Push [VFO/LOCK] to select VFO mode.
 ➔ Set the frequency via the keypad or [▲]/[▼].
- 2 Push [FUNC] then [CLR A(MW)] momentarily.
- 3 Push [▲] or [▼] to select scan edge channels, 1A, 2A, 3A, 4A or 5A.
- 4 Push [FUNC], then push [CLR A(MW)] for 1 sec. to program.
 - 3 beeps sound and VFO is automatically selected.
 - Memory channel number advances to the next scan edge channel, 1b, 2b, 3b, 4b or 5b when continuing to push [CLR A(MW)] after programming.

- 5 To program a frequency for the other scan edge channels, repeat steps 1 to 4.

[EXAMPLE]: Programming 145.800 MHz into scan edge 1b.

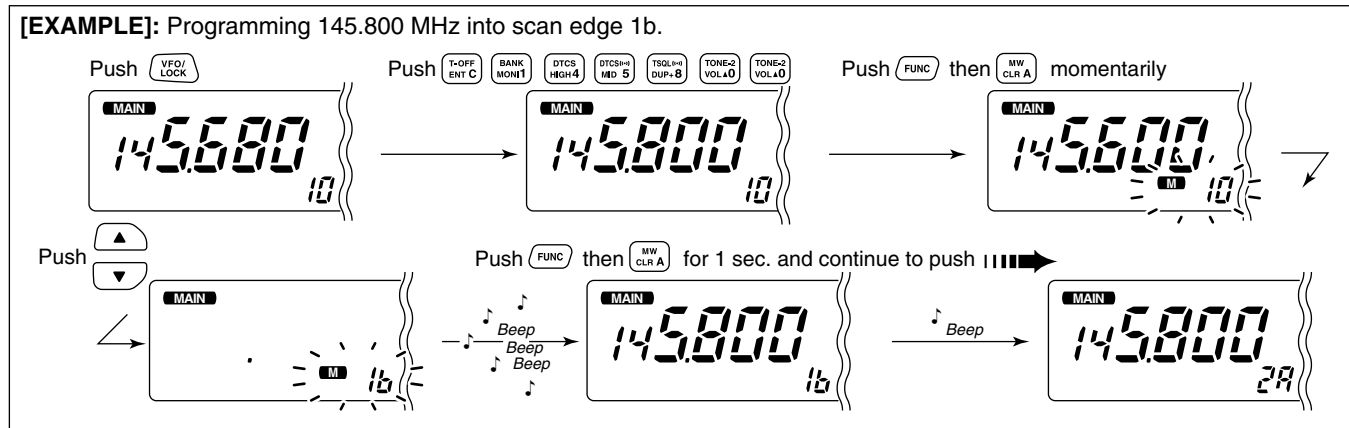

■ Skip channel setting

USING SET MODE

The memory skip function speeds up scanning by checking only those memory channels not set as skip channels. Set skip channels as follows.

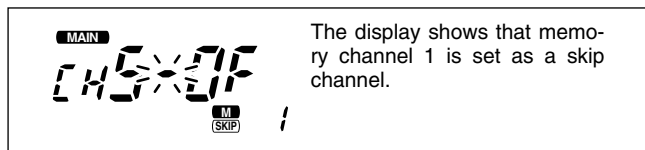

- ① Select a memory channel in the desired band:
 - ➔ Push the desired band's [M/CALL•MW] to select memory mode.
 - ➔ Rotate the same band's [DIAL] to select the desired channel to be a skip channel.
- ② Push [SET•] to enter set mode.
- ③ Push [SET•] or [LOW•PRIO] several times until "CHS" appears as shown above.
- ④ Rotate the [DIAL] to turn the skip function ON or OFF for the selected channel.
 - "" appears : The channel is skipped during scan. (CHS-On)
 - "" disappears : The channel is scanned during scan. (CHS-OF)
- ⑤ Push [TONE•DTMF] to exit set mode.





- ① Select a memory channel.
 - ➔ Select memory mode by pushing [MR/CALL].
 - ➔ Push [▲] or [▼] to select the desired channel to be a skip channel.
 - Direct memory channel selection is also available.
- ② Push [SET B(D-OFF)] to enter set mode.
- ③ Push [SET B(D-OFF)] or [ENT C(T-OFF)] several times until "CHS" appears as shown at left.
- ④ Push [▲] or [▼] to set or cancel the skip setting.
 - See item ④ at left for skip indicator details.
- ⑤ Push [CLR A(MW)] to exit set mode.

■ Scan resume condition

USING SET MODE

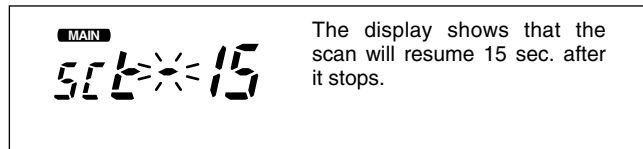
The scan resume condition can be selected as timer or pause scan. The selected resume condition is also used for priority watch. (p. 46)



- ① Push [MAIN•BAND] to select the desired band (left or right) as the main band.
- ② Push [SET•- ③ Push [SET•- When “d” is displayed in place of the 100 MHz digit, cancel the DTMF memory encoder in advance. (p. 49)
- ④ Rotate the main band’s [DIAL] to set the desired timer:
 - “SCt-15” : Scan pauses 15 sec. while receiving a signal.
 - “SCt-10” : Scan pauses 10 sec. while receiving a signal.
 - “SCt-5” : Scan pauses 5 sec. while receiving a signal.
 - “SCP-2” : Scan pauses until the signal disappears and then resumes 2 sec. later.
- ⑤ Push [TONE•DTMF] to exit set mode.



- ① Push [BAND] to select the desired band (left or right) as the main band.
- ② Push [SET B(D-OFF)] to enter set mode.
- ③ Push [SET B(D-OFF)] or [ENT C(T-OFF)] several times until “SCt” or “SCP” appears as shown at left.
- ④ Push [▲] or [▼] to select the scan resume condition.
 - See item ④ at left for scan resume condition details.
- ⑤ Push [CLR A(MW)] to exit set mode.

Priority watch types

Priority watch checks for signals on a VFO frequency every 5 sec. while operating in memory mode. The transceiver has 3 priority watch types to suit your needs. You can also transmit on the VFO frequency while the priority watch operates.

The watch resumes according to the selected scan resume condition. See previous page for details.

NOTES:

- ▶ If the pocket beep function is activated, the transceiver automatically selects the tone squelch function when priority watch starts.

MEMORY CHANNEL WATCH

While operating on a VFO frequency, priority watch checks for a signal on the selected memory channel every 5 sec.

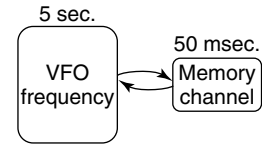

MEMORY SCAN WATCH

While operating on a VFO frequency, priority watch checks for signals on each memory channel in sequence.

- The memory skip function is useful to speed up the scan.

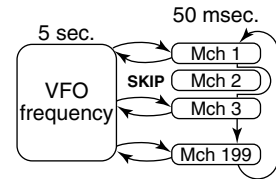

CALL CHANNEL WATCH

While operating on a VFO frequency, priority watch checks for signals on the call channel every 5 sec.

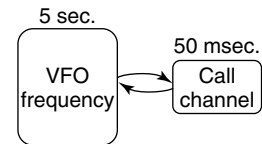

■ Priority watch operation

- ① Select VFO mode; then, set an operating frequency in the desired band (left or right).
- ② Set the watching channel(s).
 - For memory channel watch:**
Select the desired memory channel.
 - For memory scan watch:**
Select memory mode; then, push the same band's [V/MHz•SCAN] for 1 sec. to start memory scan.
 - For call channel watch:**
Select the desired call channel by pushing the same band's [M/CALL•MW] once or twice, then rotate the [DIAL].
- ③ Push [LOW•PRIO] for 1 sec. to start the watch.
 - The transceiver checks the memory or call channel every 5 sec.
 - The watch resumes according to the selected scan resume condition. (p. 44)
 - While the watch is pausing, pushing the [M/CALL(PRIO)] resumes the watch manually.
- ④ Push [LOW•PRIO] for 1 sec. to stop the watch.



- ① Select VFO mode; then, set the desired frequency.
- ② Set the watching channel(s).
 - For memory channel watch:**
Push [MR/CALL] then [▲] or [▼] to select the desired memory channel.
 - For memory scan watch:**
Push [MR/CALL], then push [SCAN 2] to start the memory scan.
 - For call channel watch:**
Push [MR/CALL] for 1 sec. then push [▲] or [▼] to select the call channel.
- ③ Push [PRIO 3(PTT-M)] to start the watch.
 - The transceiver checks the memory or call channel every 5 sec.
 - The watch resumes according to the selected scan resume condition. (p. 44)
 - To resume the watch manually when paused, push [PRIO 3(PTT-M)] or [CLR A(MW)].
- ④ To stop the watch, push [CLR A(MW)] once (or twice while watch is paused).

■ Programming a DTMF code

DTMF tones are used for autopatching, controlling other equipment, etc. The transceiver has 14 DTMF memory channels (d0–dd) for storage of often-used DTMF codes of up to 24 digits.

- ① Push [TONE•DTMF] for 1 sec. to turn the DTMF encoder ON.
 - Select the main band in advance, by pushing the desired band's [MAIN•BAND], if necessary.
 - "d" appears in place of the main band's 100 MHz digit.
- ② Push [SET•] to enter the DTMF memory programming condition.
 - The DTMF memory channel indication blinks.

- ③ Rotate the main band's [DIAL] to select the desired DTMF memory channel.
- ④ Push [SET•].
 - The first digit blinks.
- ⑤ Rotate the [DIAL] to select the desired code.
- ⑥ Push [SET•] to select the next digit.
 - Pushing [LOW•PRIO] move the cursor backward.
- ⑦ Repeat the steps ⑤ and ⑥ to set the desired DTMF tone sequence.
 - The S/R/F indicator shows the digit group. The indication increases every 6 digits.
- ⑧ Push [TONE•DTMF] to exit DTMF memory programming condition.
 - Return to the previous indication as in step ①.

[EXAMPLE]: Programming "5428AB" into DTMF memory channel "d4."

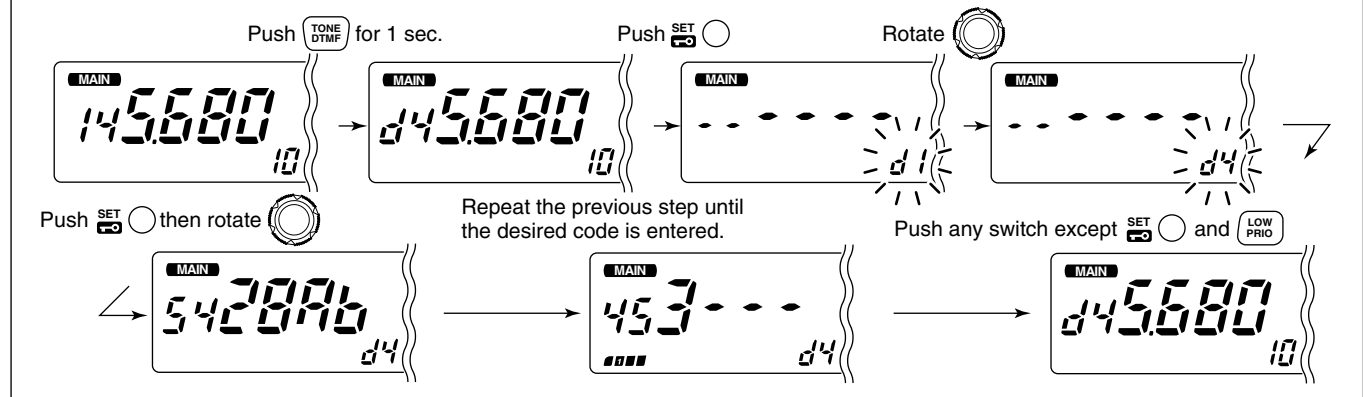

◇ Programming a DTMF code— via microphone



- 1 Push [FUNC] then [LOW 6(DTMF)] to turn the DTMF encoder ON.
 - “d” appears in place of the main band’s 100 MHz digit.
- 2 Push [SET B(D-OFF)] to enter the DTMF memory programming condition.
- 3 Push [▲] or [▼] to select the desired DTMF memory channel.
- 4 Push the desired digit keys.
 - When the first digit is input, previous memory contents are cleared automatically.
 - “E” stands for “*” and “F” stands for “#.”
 - Push [▲]/[▼] and repeat this step if you make a mistake.
 - The S/RF indicator shows the digit group. The indication increases every 6 digits.

- 5 Push [VFO/LOCK] to exit the programming condition.
 - The [CLR A(MW)] key cannot be used to exit. If pushed, code “A” is input. Reprogram in such a case.

[EXAMPLE]: Programming “542896” into DTMF memory channel “d4.”

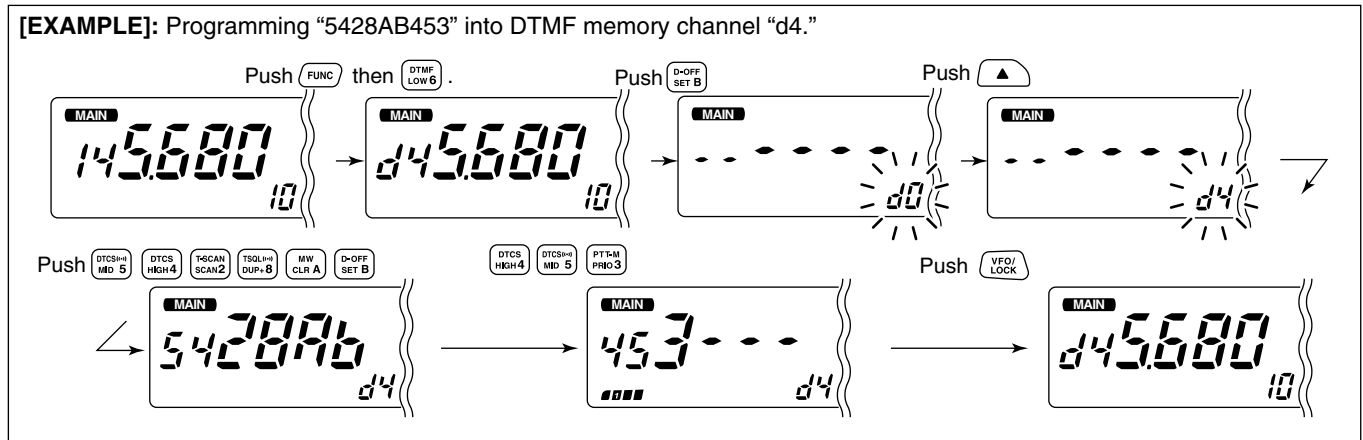

■ Transmitting a DTMF code

◇ Automatic transmission (DTMF memory)

- ① Push [TONE•DTMF] for 1 sec. to turn the DTMF memory encoder ON.
 - “d” appears in place of the main band’s 100 MHz digit.
- ② Push [SET•- ③ Rotate main band’s [DIAL] to select the desired DTMF memory channel.
- ④ Push [PTT] to transmit the selected DTMF memory content.
- ⑤ Push [TONE•DTMF] for 1 sec. to cancel the DTMF encoder.
 - When the DTMF encoder is turned ON continuously, each push of the PTT transmits the previously selected DTMF code.



- ① Push [FUNC] then [Low 6(DTMF)] to turn the DTMF memory encoder ON.
 - “d” appears in place of the main band’s 100 MHz digit.
- ② Push [SET B(D-OFF)] to enter the DTMF memory programming condition.
- ③ Push [▲] or [▼] to select the desired channel.
- ④ Push [PTT] to transmit the selected memory.
 - Exit the programming condition automatically.
 - Each push of [PTT] transmits the DTMF code.
- ⑤ Push [FUNC] then [SET B(D-OFF)] to cancel the DTMF memory encoder.
 - When the DTMF encoder is turned ON continuously, each push of the PTT transmits the previously selected DTMF code.

◇ Transmitting a DTMF memory directly



- ① Push [FUNC] then [Low 6(DTMF)] to turn the DTMF memory encoder ON.
 - “d” appears in place of the main band’s 100 MHz digit.
- ② Push [DTMF-S] to turn the DTMF memory direct selection ON.
 - The function indicator (microphone) lights green.
- ③ Push the desired DTMF channel.
 - “0” to “9” and “A” to “D” are available for DTMF memory channels.
 - The selected DTMF code is automatically transmitted without pushing PTT.

NOTE: When no DTMF code programmed channel number is pushed, it transmits the relative DTMF code as the manual transmission described in the next page.
- ④ Push [DTMF-S] again to deactivate the DTMF memory direct selection.
- ⑤ Push [FUNC] then [SET B(D-OFF)] to cancel the DTMF memory encoder.

◇ Manual transmission



- 1 Deactivate the DTMF memory encoder by pushing [FUNC] then [SET B(D-OFF)].
- 2 Push [DTMF-S] to turn the DTMF direct selection ON.
 - The function indicator (microphone) lights green.
- 3 Push one of “0” to “9” and “A” to “F” keys momentarily, then push the desired DTMF keys, 0–9 and A to F.
 - A: [CLR A(MW)] B: [SET B(D-OFF)],
 - C: [ENT C(T-OFF)] D: [SQL▲ D(MUTE)],
 - E: [* (TONE-1)] F: [SQL▼ # (16KEY-L)]
 - Automatically transmits without pushing PTT.
 - The first code, one of “A” to “F,” is not transmitted. DTMF code transmission starts from the 2nd code.
- 4 Push [DTMF-S] again to deactivate the DTMF direct selection.

■ DTMF speed

USING INITIAL SET MODE

The rate at which DTMF memories send individual DTMF characters can be set to accommodate operating needs.

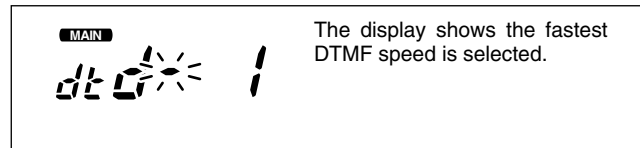

- ① Push [PWR] for 1 sec. to turn power OFF.
- ② While pushing [SET•], push [PWR] for 1 sec. to turn power ON and enter initial set mode.
- ③ Push [SET•] or [LOW•PRIO] several times until “dtd” appears as shown above.
- ④ Rotate the left band’s [DIAL] to select the desired speed as shown in the table below.
- ⑤ Push [PWR] to exit initial set mode.

DISPLAY	INTERVAL	SPEED
dtd-- 1	100 msec.	5.0 cps
dtd-- 2	200 msec.	2.5 cps
dtd-- 3	300 msec.	1.6 cps
dtd-- 5	500 msec.	1.0 cps

cps=characters/sec

10 POCKET BEEP AND TONE SQUELCH

■ Pocket beep operation

This function uses subaudible tones for calling and can be used as a “common pager” to inform you that someone has called while you were away from the transceiver.

◇ Waiting for a call from a specific station

- ① Set the operating frequency.
- ② Push [SET•] to enter set mode in the main band.
- ③ Push [SET•] or [LOW•PRIO] several times until “Ct” for tone squelch or “dt” for DTCS squelch appears.

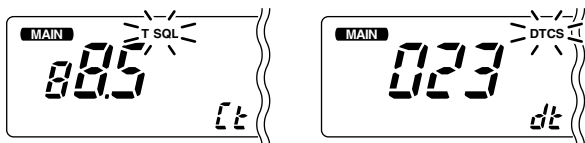

Tone squelch frequency setting DTCS code setting

- ④ Rotate the main band's [DIAL] to select the desired tone squelch frequency.
- ⑤ When operating the pocket beep function with DTCS squelch, push [SET•] once then rotate [DIAL] to select the DTCS polarity.

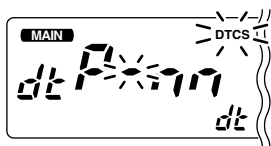

DTCS polarity setting

- ⑥ Push [TONE•DTMF] to exit set mode.
- ⑦ Push [TONE•DTMF] several times until “T SQL ((•))” or “((•)) DTCS” are displayed to turn ON the pocket beep with tone squelch or DTCS squelch, respectively.

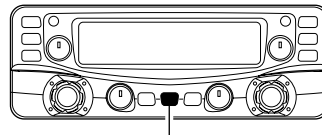

Push [TONE•DTMF] several times to select the pocket beep function with tone squelch or DTCS squelch.

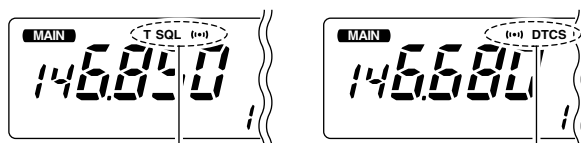

Appears when the pocket beep with tone squelch is activated.

Appears when the pocket beep with DTCS squelch is activated.

- ⑧ When a signal with the matched tone is received, the transceiver emits beep tones and blinks “((•))”.
 - Beep tones sound for 30 sec. and “((•))” blinks. To stop the beeps and blinking manually, push any key. When the beep tones are not stopped manually, “((•))” continues blinking until [PTT] is pushed (see step ⑨).
- ⑨ Push [PTT] to answer.
 - “((•))” disappears and cancels the pocket beep function automatically.
- ⑩ Push [TONE•DTMF] several times until “T SQL” or “DTCS” disappears to cancel the tone squelch or DTCS squelch function.

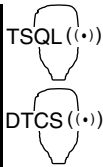

- 1 Set the operating frequency.
- 2 Program the CTCSS tone frequency or DTCS code in set mode.
 - ➔ Push [SET B(D-OFF)] to enter set mode.
 - ➔ Push [SET B(D-OFF)] or [ENT C(T-OFF)] several times until “Ct” for tone squelch or “dt” for DTCS squelch appears.
 - “T SQL” blinks when tone squelch (“Ct”), or “DTCS” blinks when DTCS squelch (“dt”) is selected.
 - ➔ Push [▲]/[▼] to select the desired tone frequency or DTCS code.
 - ➔ Push [SET B(D-OFF)] to select “dtP” then push [▲]/[▼] to select the DTCS polarity.
 - ➔ Push [CLR A(MW)] to exit set mode.
- 3 Push [FUNC] then push [DUP+ 8(TSQL ((·)))] or [MID 5(DTCS ((·)))] to turn ON the pocket beep with tone squelch or DTCS squelch, respectively.
- 4 When a signal with the matched tone is received, the transceiver emits beep tones for 30 sec. and blinks “((·)).”
- 5 Push [PTT] to answer or push [CLR A(MW)] to stop the beeps and blinking.
 - “((·))” disappears and cancels the pocket beep function automatically.
- 6 To cancel the tone squelch or DTCS squelch function, push [FUNC] then [ENT C(T-OFF)].
 - “T SQL” or “DTCS” disappears

◇ Available tone frequency list

67.0	79.7	94.8	110.9	131.8	156.7	171.3	186.2	203.5	229.1
69.3	82.5	97.4	114.8	136.5	159.8	173.8	189.9	206.5	233.6
71.9	85.4	100.0	118.8	141.3	162.2	177.3	192.8	210.7	241.8
74.4	88.5	103.5	123.0	146.2	165.5	179.9	196.6	218.1	250.3
77.0	91.5	107.2	127.3	151.4	167.9	183.5	199.5	225.7	254.1

NOTE: The transceiver has 50 tone frequencies and consequently their spacing is narrow compared to units having 38 tones. Therefore, some tone frequencies may receive interference from adjacent tone frequencies.

To prevent interference from adjacent tone frequencies, using the frequencies as in the following table, is recommended.

• Recommended tone frequencies

67.0	77.0	88.5	100.0	114.8	131.8	151.4	173.8	203.5	233.6
69.3	79.7	91.5	103.5	118.8	136.5	156.7	179.9	210.7	241.8
71.9	82.5	94.8	107.2	123.0	141.3	162.2	186.2	218.1	250.3
74.4	85.4	97.4	110.9	127.3	146.2	167.9	192.8	225.7	

◇ Calling a waiting station using pocket beep

A subaudible tone matched with the station’s CTCSS tone frequency or 3-digit DTCS code with polarity is necessary. Use the tone squelch on the next page or a subaudible tone encoder (pgs. 25, 26).

■ Tone/DTCS squelch operation

The tone or DTCS squelch opens only when receiving a signal with the same pre-programmed subaudible tone or DTCS code, respectively.

- ① Set the operating frequency in the main band.
- ② Program the CTCSS tone frequency or DTCS code in set mode.
 - See p. 51 for programming details.
- ③ Push [TONE•DTMF] several times until “T SQL” or “DTCS” appears in the function display.
- ④ When a signal with the matched tone is received, the squelch opens and the signal can be heard.
 - When the received signal includes an unmatched tone, the squelch does not open. However, the S/RF indicator shows the received signal strength.
 - To open the squelch manually, push [DUP•MONI].
- ⑤ Operate the transceiver in the normal way (push [PTT] to transmit; release [PTT] to receive).
- ⑥ To cancel the tone squelch, push [TONE•DTMF] several times until “T SQL” or “DTCS” disappears.



- ① Set the operating frequency.
- ② Program the CTCSS tone frequency or DTCS code in set mode.
 - See p. 52 for programming details.
- ③ Push [FUNC] then [SIMP 9(TSQL)] or [HIGH 4(DTCS)] to turn the tone squelch or DTCS squelch ON.
- ④ When a signal with the matched tone is received, the squelch opens and the signal can be heard.
 - When the received signal includes an unmatched tone, the squelch does not open. However, the S/RF indicator shows the received signal strength.
 - To open the squelch manually, push [MONI 1(BANK)].
- ⑤ Operate the transceiver in the normal way (push [PTT] to transmit; release [PTT] to receive).
- ⑥ To cancel the tone squelch, push [FUNC] then [ENT C(T-OFF)].
 - “T SQL” or “DTCS” disappears

NOTE: The DTCS squelch operation on sub band will not be performed during DTCS transmission, due to the same encoder/decoder circuit is used for both main and sub bands. And the tone squelch operation on sub band may not be performed correctly during DTCS transmission.

■ Tone scan

By monitoring a signal that is being operated with pocket beep, tone or DTCS squelch function, you can determine the tone frequency or DTCS code necessary to open a squelch.

- ① Set the desired operating frequency or memory channel to be checked for a tone frequency or code in the main band.
- ② Push [TONE•DTMF] several times to select the tone type, tone squelch or DTCS, to be scanned.
 - Either “T SQL” or “DTCS” appears
- ③ Push the main band’s [V/MHz•SCAN] for 1 sec. to start the tone scan.
 - To change the scanning direction, rotate [DIAL].

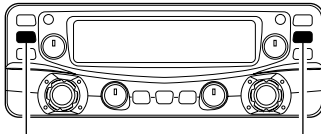

Push [V/MHz•SCAN] for 1 sec. to start tone scan.

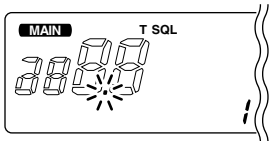

During CTCSS frequency scan

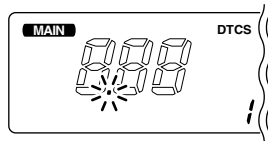

During DTCS code scan

NOTE: The decoded tone frequency is programmed temporarily when a memory or call channel is selected. However, this will be cleared when the memory/call channel is re-selected.

- ④ When the CTCSS tone frequency or 3-digit DTCS code is matched, the squelch opens and the tone frequency is temporarily programmed into the selected condition such as memory or call channel.
 - The tone scan pauses when a CTCSS tone frequency or 3-digit DTCS code is detected.
 - The decoded CTCSS tone frequency or 3-digit DTCS code is used for the tone encoder or tone encoder/decoder depending on the selected tone condition or type in step ②.
 - “T SQL” : CTCSS tone encoder/decoder
 - “DTCS” : DTCS tone encoder/decoder
- ⑤ Push [V/MHz•SCAN] to stop the scan.



- ① Set the frequency or memory channel to be checked for a tone frequency.
- ② Selects the tone type to be scanned.
 - Push [FUNC] then push; [SIMP 9(TSQL)] for tone squelch; [HIGH 4(DTCS)] for DTCS squelch.
- ③ Push [FUNC] then [SCAN 2(T-SCAN)] to start the tone scan.
- ④ When the tone frequency is matched, the squelch opens and the tone frequency is programmed into the selected mode such as memory or call channel.
- ⑤ Push [CLR A(MW)] to stop the scan.

11 OTHER FUNCTIONS

■ Set mode

• Set mode operation

- ① Push the desired band's [MAIN•BAND] to select the main band.
- ② Push [SET•] to enter the set mode.
- ③ Push [SET•] or [LOW•PRIO] to select the desired item.
- ④ Rotate the main band's [DIAL] to select the condition or value.
- ⑤ Push [TONE•DTMF] to exit set mode.



- 1 Push [BAND] to select the main band.
- 2 Push [SET B(D-OFF)] to enter set mode.
- 3 Push [SET B(D-OFF)] or [ENT C(T-OFF)] to select the desired item.
- 4 Push [▲] or [▼] to select the condition or value.
- 5 Push [CLR A(MW)] to exit set mode.

• Set mode items

<ul style="list-style-type: none"> • Mode selection ← ← ← ← 	<ul style="list-style-type: none"> • 1st Lo frequency 	<ul style="list-style-type: none"> • Display dimmer 	<ul style="list-style-type: none"> • Display color 	<ul style="list-style-type: none"> • Repeater tone frequency 		
<ul style="list-style-type: none"> • Narrow setting[†] 	<ul style="list-style-type: none"> • Tone squelch frequency 	<ul style="list-style-type: none"> • DTCS code 	<ul style="list-style-type: none"> • Scan resume timer 	<ul style="list-style-type: none"> • Tuning step 	<ul style="list-style-type: none"> • Offset frequency 	<ul style="list-style-type: none"> • DTCS polarity
<ul style="list-style-type: none"> • Channel skip setting[†] 	<ul style="list-style-type: none"> • DTCS code 	<ul style="list-style-type: none"> • DTCS polarity 	<ul style="list-style-type: none"> • Scan resume timer 	<ul style="list-style-type: none"> • Tuning step 	<ul style="list-style-type: none"> • Offset frequency 	<ul style="list-style-type: none"> • DTCS polarity

↓ ↑ : Push (front panel); or (microphone)
 → : Push (front panel); or (microphone)

[†]Appears when accessing set mode from memory mode only.
[†]Appears when accessing set mode from left band only.

◆ Display dimmer

Adjust to suit lighting conditions. The levels 1 (dark) to 4 (bright: default) are available.



◆ Display color

The display color can be set to amber (default) or green.



• Amber setting



• Green setting

◆ Repeater tone

Sets subaudible tone frequency (encoder only) for repeater operation. Total of 50 tone frequencies (67.0–254.1 Hz) are available. (default: 88.5 Hz)



◆ Tone squelch tone

Sets subaudible tone frequency (both encoder and decoder) for tone squelch operation. Total of 50 tone frequencies (67.0–254.1 Hz) are available. (default: 88.5 Hz)



• Available subaudible tone frequencies

67.0	79.7	94.8	110.9	131.8	156.7	171.3	186.2	203.5	229.1
69.3	82.5	97.4	114.8	136.5	159.8	173.8	189.9	206.5	233.6
71.9	85.4	100.0	118.8	141.3	162.2	177.3	192.8	210.7	241.8
74.4	88.5	103.5	123.0	146.2	165.5	179.9	196.6	218.1	250.3
77.0	91.5	107.2	127.3	151.4	167.9	183.5	199.5	225.7	254.1

◆ DTCS code

Sets DTCS code (both encoder and decoder) for DTCS squelch operation. Total of 104 codes are available. (default: 023)



11 OTHER FUNCTIONS

◇ DTCS polarity

Sets DTCS polarities for transmission and reception from “nn,” “nr,” “rn” and “rr.” (default: nn)

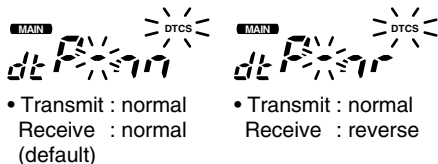

◇ Offset frequency

Sets the duplex offset frequency within 0 to 20 MHz range. During duplex (repeater) operation, transmit frequency (or receive when reverse function is set to ON) shifts the set frequency. (default value may differ depending on operating frequency band and versions)



◇ Tuning step

Selects tuning step from 5, 10, 12.5, 15, 20, 25, 30 and 50 kHz for [DIAL] or [▲]/[▼] operation. (default value may differ depending on operating frequency band and versions)



◇ Scan resume timer

Selects scan resume timer from SCT-15 (default), SCT-10, SCT-5 and SCP-2.

- SCT-15/10/5 : Scan pauses for 15/10/5 sec., then resumes.
- SCP-2 : Pause on a signal until signal disappears, then resumes 2 sec. after the signal disappears.



◇ Channel skip setting

Sets channel skip setting from ON and OFF for memory skip scan operation.

This item appears when set mode is accessed from memory mode only.



- Default setting
- “[SKIP]” appears when set to “On.”

◇ Wide/Narrow setting (Left band only)

Sets both the transmission and reception passband width from wide and narrow.

When narrow is set, the transmission deviation and reception passband width become half of the wide setting (approx.).

This setting can be set for each memory, call and VFO independently.

This item appears when set mode is accessed from left band only.



◇ Operating mode setting

Selects the operating mode for the desired frequency band from FM and AM.

This setting can be set for each memory, call and VFO independently.



◇ 1st Lo frequency selection

Selects the 1st Lo (Local Oscillator) frequency from normal (n) and reverse (r).

By changing local oscillator frequency, the transceiver may reject interference or image frequencies, such as from other stations spurious or the transceiver's internal oscillator.



This item can also be switched by pushing [SET] while transmitting (pushing and holding [PTT]) for sub band (non-main band) setting.

It is helpful in case the transceiver receiving heterodyne spurious emissions, or receiving on an image frequency from own transmitter.

The local oscillator frequency can be switched when selecting a frequency within 2 m band in left band, or 70 cm band in right band only.

11 OTHER FUNCTIONS

Initial set mode

AT POWER ON

The initial set mode is accessed at power ON and allows you to set seldom-changed settings. In this way, you can “customize” transceiver operations to suit your preference and operating style.

Initial set mode items

◇ Entering initial set mode

- ① While pushing [SET•], push [PWR] for 1 sec. to enter initial set mode.
- ② Push [SET•] or [LOW•PRIO] to select the desired item.
- ③ Rotate left band's [DIAL] to select the condition or value.
- ④ Push [PWR] momentarily to exit initial set mode.

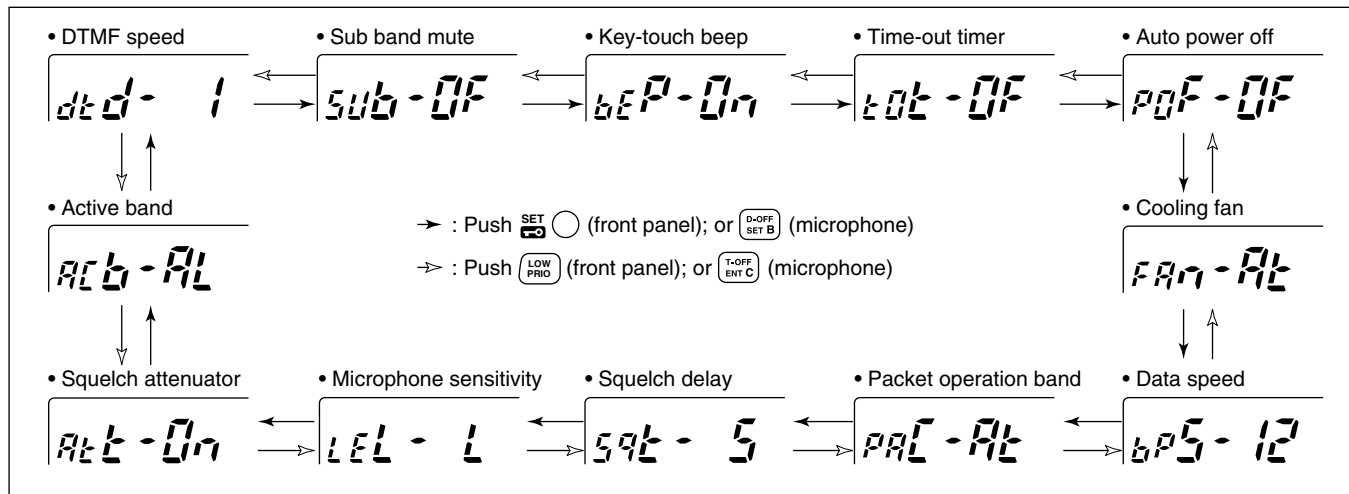

◆ Key-touch beep

The key-touch beep can be turned OFF for silent operation. (default: ON)

bEP*OF bEP*On

◆ Time-out timer

To prevent accidental prolonged transmission, etc., the transceiver has a time-out timer. This function cuts a transmission OFF after 1–30 min. of continuous transmission. This timer can be cancelled.



- TOT-OFF : The time-out timer is turned OFF. (default)
- TOT-3/5/15/30 : The transmission is cut OFF after the set period elapses.

tOt*OF tOt*5

◆ Auto power OFF

The transceiver can be set to automatically turn OFF after a specified period with a beep when no key operations are performed.

30 min., 1 hour, 2 hours and OFF (default) can be specified. The specified period is retained even when the transceiver is turned OFF by the auto power OFF function. To cancel the function, select “OF” in this set mode.

pOF*OF pOF*30

◆ Cooling fan control

Selects the cooling fan control condition from Auto and ON.

- Auto (At) : The fan rotates during transmit and for 2 min. after transmission.
- ON (On) : The fan continuously rotates.

fAr*At fAr*On

◆ Data transmission speed

Selects the data transmission speed for packet operation from 1200 bps (default) and 9600 bps.

bPS*12 bPS*96

11 OTHER FUNCTIONS

◆ Packet operation band

Selects the packet operation band from auto, right and left.

- Auto (At) : The main band is used for packet operation.
- Left (L)/Right (r) : The selected left or right band can only be operated for packet.



◆ Squelch delay

Selects squelch delay from short and long to prevent repeated opening and closing of the squelch during reception of the same signal.

- S : Short squelch delay. (default)
- L : Long squelch delay



◆ Microphone sensitivity

Selects the microphone sensitivity from high (H) and low (L) to suits your preference.



◆ Squelch attenuator

Turns the squelch attenuator function ON and OFF.

- ON : The squelch attenuator activates when [SQL] control is set between 12 o'clock and fully clockwise position. (default)
- OF : The squelch attenuator does not function.



◆ Active band

Selects the frequency selecting condition via [DIAL] or [▲]/[▼] on the microphone from all (AL) and single (SI).

- All (AL) : The operating frequency can be selected continuously. (default)
- Single (SI) : The operating frequency can be selected within the current band. Pushing [MAIN•BAND] for 1 sec. then tuning dial rotation is necessary for frequency band selection.



◇ DTMF speed

The rate at which DTMF memories send individual DTMF characters can be set to accommodate operating needs.

- 1 : 100 msec. interval; 5.0 cps speed (default)
- 2 : 200 msec. interval; 2.5 cps speed
- 3 : 300 msec. interval; 1.6 cps speed
- 5 : 500 msec. interval; 1.0 cps speed

dtc* 1 dtc* 5

◇ Sub band mute

Turns the sub band function with sub band busy beep capability ON and OFF.



DISPLAY	SUB BAND MUTE	BUSY BEEP
SU _b -OF	OFF	OFF
SU _b -OF ((*))	OFF	ON
SU _b -On	ON	OFF
SU _b -On ((*))	ON	ON

sub*OF sub*On

11 OTHER FUNCTIONS

■ AM/FM narrow mode USING SET MODE

The IC-2725E has AM mode reception for both the left and right bands, and FM narrow mode is available for the left band.

- ① Select the desired frequency band in VFO mode, or the desired memory channel on the left or right band as desired.
 - If you want to select FM narrow mode, select the desired frequency band or memory channel on the left band.
- ② Push [SET•] to enter set mode.
- ③ Push [SET•] or [LOW•PRIO] to select “nAr” item or “COn” item.
 - Select “nAr” for Wide/Narrow setting.
 - Select “COn” for operating mode setting.

• Wide/Narrow setting

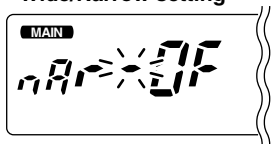

• Operating mode setting

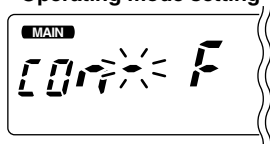

- ④ Rotate the same band's [DIAL] to select FM narrow or AM as desired.
 - “AM” appears when AM mode is selected.
- ⑤ Push [TONE•DTMF] to exit set mode.



- ① Push [BAND] to select the desired band (left or right) as the main band.
 - If you want to select FM narrow mode, select the desired frequency band or memory channel on the left band.
- ② Set the desired frequency or memory channel.
- ③ Push [SET B(D-OFF)] to enter set mode.
- ④ Push [SET B(D-OFF)] or [ENT C(T-OFF)] to select “nAr” item or “CO n” item.
 - Select “nAr” for Wide/Narrow setting.
 - Select “CO n” for operating mode setting.
- ⑤ Push [▲]/[▼] to select FM narrow or AM as desired.
- ⑥ Push [CLR A(MW)] to exit set mode.

■ Microphone keys

The supplied HM-133's (optional for some versions) [F-1] and [F-2] keys memorize the transceiver conditions.

The [UP]/[DN] keys of the standard or an optional microphone (other than the HM-133) can be assigned functions like the function keys on the transceiver's front panel.

◇ [UP]/[DN] keys on a microphones

(other than HM-133)

AT POWER ON

The following functions are assigned to the [UP]/[DN] keys on the other microphones (HM-118N/TN, etc.) when first applying power.

• Default setting

[UP] : channel up; push and hold to start scan, push again to stop scan.

[DN] : channel down; push and hold to start scan, push again to stop scan.

➔ Assigning a function

- ① Turn the power OFF.
- ② While pushing the desired switch on the transceiver and one of either [UP]/[DN] keys on the microphone, turn the power ON.
 - The function is programmed into the key.

➔ Clearing an assignment

- ① Turn the power OFF.
- ② While pushing the desired [UP] or [DN] key on the microphone, turn the power ON.

◇ [F-1]/[F-2] keys on HM-133

The following conditions in the main band or both left and right bands can be memorized into [F-1] and [F-2] keys, independently.

- Operating frequency
- Repeater setting (offset direction and frequency, tone ON/OFF and frequency)
- Tone/DTCS squelch (ON/OFF, frequency/code and polarity)
- Transmit output power selection
- Tuning step
- Operating mode selection (FM/AM)
- Set mode settings*
- Initial set mode settings*

*Only when storing both bands conditions



➔ Programming the both bands condition

After setting the desired contents of each condition in the both bands, push [FUNC] then push [F-1]/[F-2] for 1 sec.

- 3 beeps sound.

➔ Recalling the both bands condition

Push [FUNC] then [F-1]/[F-2] momentarily.

➔ Programming the main band condition

Set the desired contents of each condition in the main band, then push [F-1]/[F-2] for 1 sec.

- 3 beeps sound.

➔ Recalling the main band condition

Push [F-1]/[F-2] momentarily.

11 OTHER FUNCTIONS

■ Partial reset

AT POWER ON

If you want to initialize the operating conditions (VFO frequency, VFO settings, set mode contents) without clearing the memory contents, a partial resetting function is available for the transceiver left and right bands independently.

- ➔ While pushing desired band's [V/MHz•SCAN], turn the power ON to partially reset the desired band (left or right).

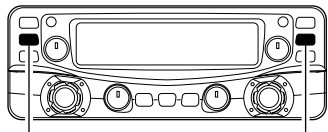

Left band partial reset.

Right band partial reset.

✓ *Hint!*

When pushing both [V/MHz•SCAN] and turning the power ON, partially reset both bands at the same time.

■ ALL reset

AT POWER ON

The function display may occasionally display erroneous information (e.g. when first applying power). This may be caused externally by static electricity or by other factors.

If this problem occurs, turn power OFF. After waiting a few seconds, turn power ON again. If the problem persists, perform the following procedure.

- Partial resetting is also available. See left for details.

/// **IMPORTANT!:**

Resetting the transceiver **CLEARs** all memory information and initializes all values in the transceiver.

- ➔ While pushing both band's [M/CALL•MW], turn the power ON to reset the CPU.

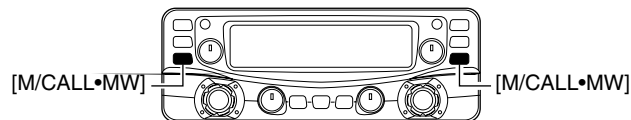

While pushing both [M/CALL•MW], turn power ON.

■ Data cloning

AT POWER ON

Cloning allows you to quickly and easily transfer the programmed contents from one transceiver to another; or, data from a personal computer to a transceiver using the optional CS-2720 CLONING SOFTWARE.

◇ Cloning between transceivers

- 1 Connect the OPC-474 cloning cable to the [SP-2] jack of the master and sub-transceivers.
 - The master transceiver is used to send data to the sub-transceiver.

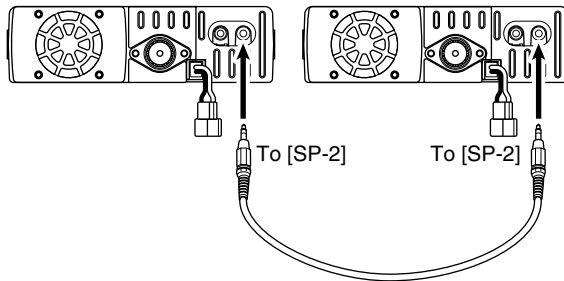

- 2 While pushing left band's [M/CALL•MW], turn power ON to enter cloning mode (master transceiver only— power ON only for sub-transceiver).
 - "CLOnE" appears and the transceivers enter the clone standby condition.

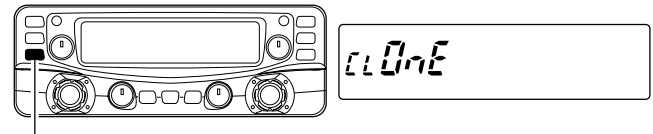

While pushing left band's [M/CALL•MW], turn power ON.

- 3 Push the same [M/CALL•MW] on the master transceiver.
 - "CLOnE OUT" appears in the master transceiver's display and the S/Rf indicators show that data is being transferred to the sub-transceiver.
 - "CLOnE In" appears automatically in the sub-transceiver's display and the S/Rf indicators show that data is being received from the master transceiver.

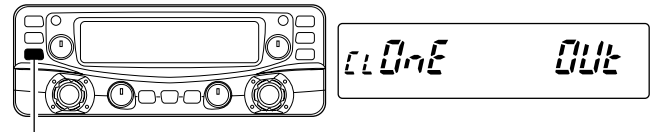

Pushing left band's [M/CALL•MW] start cloning.

- 4 When cloning is finished, turn power OFF, then ON to exit cloning mode.

11 OTHER FUNCTIONS

◇ Cloning using a personal computer

Data can be cloned to and from a personal computer (Microsoft® Windows® 98/2000/Me/XP) using the optional CS-2720 CLONING SOFTWARE and the optional cloning cable OPC-478U (USB type) or OPC-478 (RS-232C type). Consult the CS-2720 CLONING SOFTWARE HELP file for details.

◇ Cloning error

NOTE: DO NOT push any key on the sub-transceiver during cloning. This will cause a cloning error.

When the display as below appears, a cloning error has occurred.

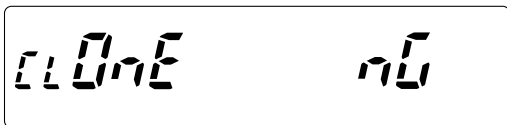



In such a case, both transceivers automatically return to the clone standby condition and cloning must be repeated.

Microsoft and Windows are registered trademarks of Microsoft Corporation in the U.S.A. and other countries.

■ Packet operation

◇ Data speed

For packet operation, the transceiver can be set to one of two data speeds: 1200 bps (default) or 9600 bps.

- ① While pushing [SET•] turn power ON to enter initial set mode.
- ② Push [SET•] or [LOW•PRIO] to select the 'bPS' item.
- ③ Rotate the left band [DIAL] to select the desired data speed.



- ④ Push [PWR] to exit initial set mode.

/// For 1200 bps operation—

- Disconnect the microphone plug from the microphone connector during data transmission, otherwise the data signal and voice signal are simultaneously transmitted.

/// For 9600 bps operation—

- When the transceiver is set for 9600 bps data transmission in set mode, the microphone signal is automatically cut. Therefore, it is not necessary to disconnect the microphone plug from the connector in this case.
- When pushing [PTT] during data transmission, data transmission is interrupted and voice signals have priority.

◇ 1200 bps packet operation

① Connect the transceiver and a TNC as illustrated below.

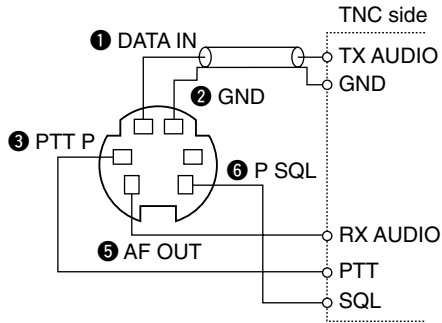

② Set the TNC for transmit.

③ Set transmit delay on the TNC to 30–50.

④ Adjust the TNC frequency deviation if necessary.

• **When using a deviation meter:**

Adjust the output of the TNC so that frequency deviation is in the range ± 3 to ± 4 kHz.

• **When NOT using a deviation meter:**

A receiver or transceiver is needed to monitor the transmission—compare the received audio output level when receiving a TNC modulated signal with high level voice signals using the microphone. Then adjust the TNC modulated signal to a lower level than the voice modulated signal.

- Read the instructions supplied with your TNC carefully before attempting packet operation with the transceiver.
- Pin ⑤ AF OUT is for 1200 bps operation only. This pin cannot be used for 9600 bps operation.
- Over modulation may degrade signal quality. If you find that many transmissions are failing, re-adjust the modulation level.

11 OTHER FUNCTIONS

◇ 9600 bps high speed packet operation

The transceiver supports 2 modes of 9600 bps packet operation: G3RUH and GMSK.

① Connect the transceiver and a TNC as illustrated below.

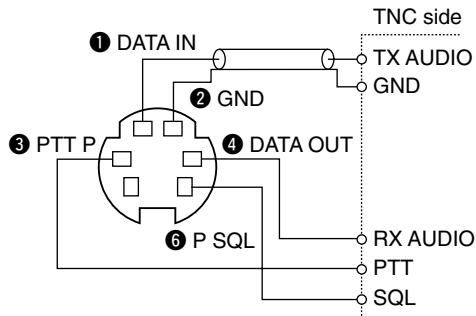

- ② G3RUH mode can handle 16 kinds of modulated wave forms in order to maintain a communication link.
- ③ Set transmit delay on the TNC to 30–50.
- ④ Adjust the TNC frequency deviation if necessary (see page at right).

- When using the PTT P terminal for packet operation, no voice signals are transmitted from the microphone.
- When pushing [PTT] during data transmission, data transmission is interrupted and the voice signal takes priority.
- Read the instructions supplied with your TNC carefully before attempting packet operation with the transceiver.
- Pin ④ DATA OUT is for 9600 bps operation only. This pin cannot be used for 1200 bps operation.

◇ Adjusting the transmit signal output from the TNC

When setting data transmission speed to 9600 bps, the data signal coming from the TNC is applied exclusively to the internal limiter circuitry to automatically maintain band width.

NEVER apply data levels from the TNC of over 0.6 V p-p, otherwise the transceiver will not be able to maintain the band width and may possibly interfere with other stations.

1. When using a level meter or synchroscope, adjust the TX audio output level (DATA IN level) from the TNC as follows.

0.4 V p-p (0.2 V rms)	: recommended level
0.2 V p-p–0.5 V p-p (0.1–0.25 V rms)	: acceptable level

2. When NOT using a measuring device.



- ① Connect the transceiver to a TNC.
- ② Enter a test mode (“CAL”, etc.) on the TNC, then transmit some test data.
- ③ *When the transceiver fails to transmit the test data or transmits sporadically (TX indicator doesn't appear or flashes):*
 - Decrease the TNC output level until the transmit indicator lights continuously.

When transmission is not successful even though the TX indicator lights continuously:

 - Increase the TNC output level.

◇ Packet operation band selection

Both bands, or either the left or right band only, can be specified for packet operation to suit your preference.

- ① While pushing [SET•>] turn power ON to enter initial set mode.
- ② Push [SET•>] or [LOW•PRIO] to select the ‘PAC’ item.
- ③ Rotate the left band [DIAL] to select the desired band from auto (At; default), left (L) and right (r).
 - Auto (At) : The main band is used for packet operation.
 - Left (L)/Right (r) : The selected left or right band can only be used for packet operation.



- ④ Push [PWR] to exit initial set mode.

12 MAINTENANCE

■ Troubleshooting

If your transceiver seems to be malfunctioning, please check the following points before sending it to a service center.

PROBLEM	POSSIBLE CAUSE	SOLUTION	REF.
Does not turn on.	<ul style="list-style-type: none"> • Power connector has a poor contact. • Polarity of the power connection is reversed. • Blown fuse. 	<ul style="list-style-type: none"> • Check the connector pins. • Re-connect the power cable observing the proper polarity. Replace the fuse if damaged. • Check the cause, then replace the fuse. 	— pgs. VI, 72 p. 72
No sound comes from the speaker.	<ul style="list-style-type: none"> • Volume is too low. • The audio mute function is activated. • Squelch is set too high. • A selective call or squelch function is activated such as pocket beep or tone squelch. 	<ul style="list-style-type: none"> • Rotate [VOL] clockwise. • Push any switch or key to deactivate it. • Set the squelch level to the threshold. • Turn the appropriate function OFF. 	p. 16 p. 21 p. 16 pgs. 51, 52, 53
Sensitivity is low and only strong signals are audible.	<ul style="list-style-type: none"> • Antenna feedline or the antenna connector has a poor contact or is short circuited. • Squelch attenuator function is activated. 	<ul style="list-style-type: none"> • Check, and if necessary, replace the feedline or solder the antenna connector again. • Set [SQL] between 10–12 o'clock position. 	p. VII p. 17
No contact possible with another station.	<ul style="list-style-type: none"> • The other station is using tone squelch. • The transceiver is set to duplex. 	<ul style="list-style-type: none"> • Turn the tone squelch function ON. • Set to simplex. 	p. 53 p. 23
Repeater cannot be accessed.	<ul style="list-style-type: none"> • Wrong offset frequency is programmed. • Wrong subaudible tone frequency is programmed. 	<ul style="list-style-type: none"> • Correct the offset frequency. • Correct the subaudible tone frequency. 	p. 27 p. 25
Frequency cannot be set.	<ul style="list-style-type: none"> • The frequency lock function is activated. • Priority watch is paused on the watching frequency. 	<ul style="list-style-type: none"> • Turn the function OFF. • Push [LOW•PRIO] for 1 sec. to cancel the watch. 	p. 15 p. 46
Frequency cannot be set via the microphone.	<ul style="list-style-type: none"> • The frequency lock function is activated. • The microphone keypad lock function is activated. • Priority watch is paused on the watching frequency. 	<ul style="list-style-type: none"> • Turn the function OFF • Push [FUNC] then [SQL▼#(16KEY-L)] to deactivate the microphone keypad lock function. • Push [LOW•PRIO] for 1 sec. to cancel the watch. 	p. 15 p. 15 p. 46

PROBLEM	POSSIBLE CAUSE	SOLUTION	REF.
Some memory channels cannot be selected via the tuning dial.	<ul style="list-style-type: none"> The memory channel number has not yet been programmed. 	<ul style="list-style-type: none"> Select the channel via the microphone keypad to check whether the channel has been programmed or not. 	—
Scan does not operate.	<ul style="list-style-type: none"> The squelch is open. Only 1 memory channel is programmed or other channels are set as skip channels. Priority watch is activated. 	<ul style="list-style-type: none"> Set the squelch to the threshold point. Program other memory channels or cancel the memory skip function in the desired channels. Cancel the watch. 	p. 16 pgs. 29, 30, 43 p. 46
Transmission is automatically cut off.	<ul style="list-style-type: none"> Time-out timer is activated. 	<ul style="list-style-type: none"> Set the timer to OFF. 	p. 60
Transmission continues even when the PTT is released.	<ul style="list-style-type: none"> One-touch PTT function is activated. 	<ul style="list-style-type: none"> Turn the function OFF. 	p. 21
The function display shows erroneous information.	<ul style="list-style-type: none"> The CPU is malfunctioning. 	<ul style="list-style-type: none"> Reset the CPU. 	p. 65

■ Fuse replacement

If the fuse blows or the transceiver stops functioning, find the source of the problem if possible, and replace the damaged fuse with a new, rated one (FGB 20 A) as shown at right.

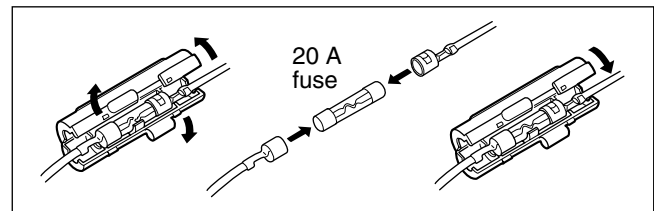

13 SPECIFICATIONS AND OPTIONS

■ Specifications

◇ GENERAL

- Frequency coverage :
 - Europe 144–146 MHz, 430–440 MHz
 - Italy 144–146 MHz, 430–434 MHz, 435–438 MHz
- Type of emission : FM, AM (Receive only)
- Number of memory channels : 212 (incl. 10 scan edges and 2 calls)
- Frequency resolution : 5, 10, 12.5, 15, 20, 25, 30, 50 kHz
- Operating temperature range : -10°C to +60°C
- Frequency stability : ±10 ppm (-10°C to +60°C)
- Power supply requirement : 13.8 V DC ±15%
- Current drain (at 13.8 V DC: approx.):
 - Transmit at 50 W 12 A
 - Receive standby 1.2 A
 - (simultaneous receive) max. audio 1.8 A
- Antenna connector : SO-239 (50 Ω)
- Dimensions (proj. not included) :
 - Main Unit 140(W) × 40(H) × 187(D) mm
 - Remote controller 140(W) × 50(H) × 24.5(D) mm
- Weight (approx.) :
 - Main unit 1.25 kg (incl. separation cable)
 - Remote controller 150 g

◇ TRANSMITTER

- Modulation system : Variable reactance frequency modulation
- Output power : VHF 50/15/5 W (approx.)
UHF 35/15/5 W (approx.)
- Max. frequency deviation : ±5.0 kHz (wide)
±2.5 kHz (narrow: Left band only)
- Spurious emissions : Less than -60 dB
- Microphone connector : 8-pin modular (600 Ω)

◇ RECEIVER

- Receive system : Double-conversion superheterodyne
- Intermediate frequencies :
 - Left band 1st: 38.85 MHz, 2nd: 450 kHz
 - Right band 1st: 46.05 MHz, 2nd: 455 kHz
- Sensitivity (FM: at 12 dB SINAD/AM: at 10 dB S/N):
 - 144 MHz band Less than 0.18 μV/0.45 μV typ.
 - 430 MHz band Less than 0.18 μV/—
- Squelch sensitivity (threshold) : Less than 0.13 μV
- Selectivity (typical) :
 - Wide More than 12 kHz/6 dB
Less than 30 kHz/60 dB
 - Narrow More than 6 kHz/6 dB
Less than 20 kHz/60 dB
- Spurious and image rejection : More than 60 dB
- AF output power (at 13.8 V DC): More than 2.4 W at 10% distortion with an 8 Ω load
- Ext. speaker connectors : 3-conductor 3.5 (d) mm/8 Ω

All stated specifications are subject to change without notice or obligation.

■ Options

HM-133 REMOTE-CONTROL MICROPHONE

Wired remote control microphone with key backlight. Same as that supplied with the transceiver.

HM-118TN DTMF MICROPHONE

HM-118N HAND MICROPHONE

HS-62 FLEXIBLE MOBILE MICROPHONE + **HS-15SB** SWITCH BOX

+ **OPC-589** ADAPTER CABLE

For all-round mobile operation.

OPC-1155 SEPARATION CABLE

Remotely install the transceiver. Cable length: 3.5 m

OPC-1156 CONTROLLER EXTENSION CABLE

Extends the OPC-1155 separation cable.

MB-84 REMOTE CONTROLLER BRACKET

Used for remote installation. OPC-1155 SEPARATION CABLE is required for installation.

MB-85 COMBINATION BRACKET

Same as that supplied with the transceiver.

MB-65 MOUNTING BASE

Mounts the remote controller on to variety of place in vehicle. MB-84 is required for mounting.

MB-17A MOBILE MOUNTING BRACKET

One-touch bracket. Transceiver main unit easily attached or removed.

OPC-440/OPC-647 MIC EXTENSION CABLES

OPC-440: 5.0 m; OPC-647: 2.5 m

OPC-441 SPEAKER EXTENSION CABLE

Cable length: 5.0 m

SP-7/SP-10 EXTERNAL SPEAKERS

SP-7: For base station use. Cable length: 1.0 m

SP-10: For all-round mobile operation. Cable length: 1.5 m

OPC-347/1132 DC POWER CABLES

OPC-347: 7.0 m

OPC-1132: 3.0 m Same as that supplied with the transceiver.

CS-2720 CLONING SOFTWARE + **OPC-478U** CLONING CABLE

Provides quick and easy programming items, such as memory channels, set mode contents for local repeater frequencies, via PC's USB terminal. RS-232C type cloning cable, OPC-478, also available.

OPC-474 CLONING CABLE

Used for data cloning between transceivers.

14 MODE ARRANGEMENT

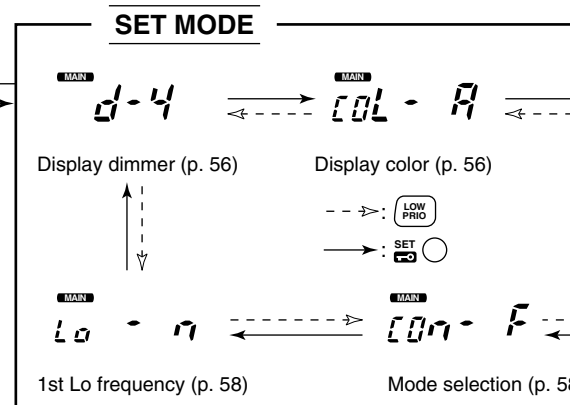
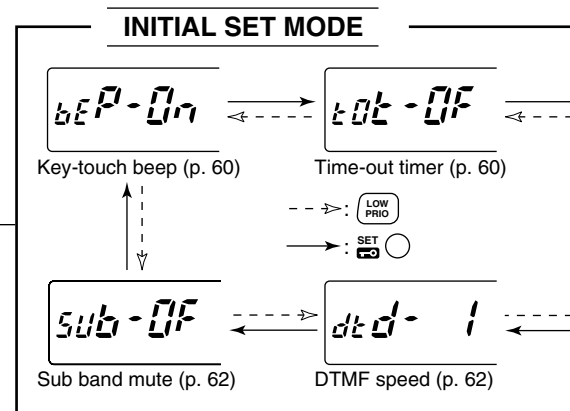
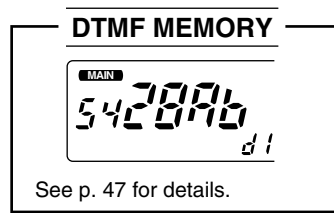
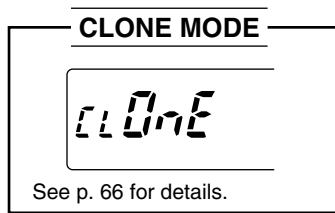
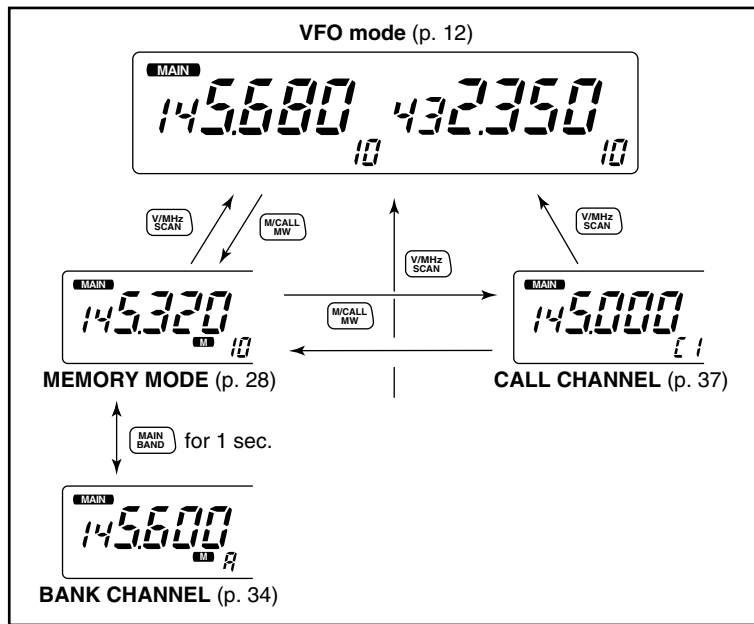

PWR

When the DTMF memory encoder is activated.

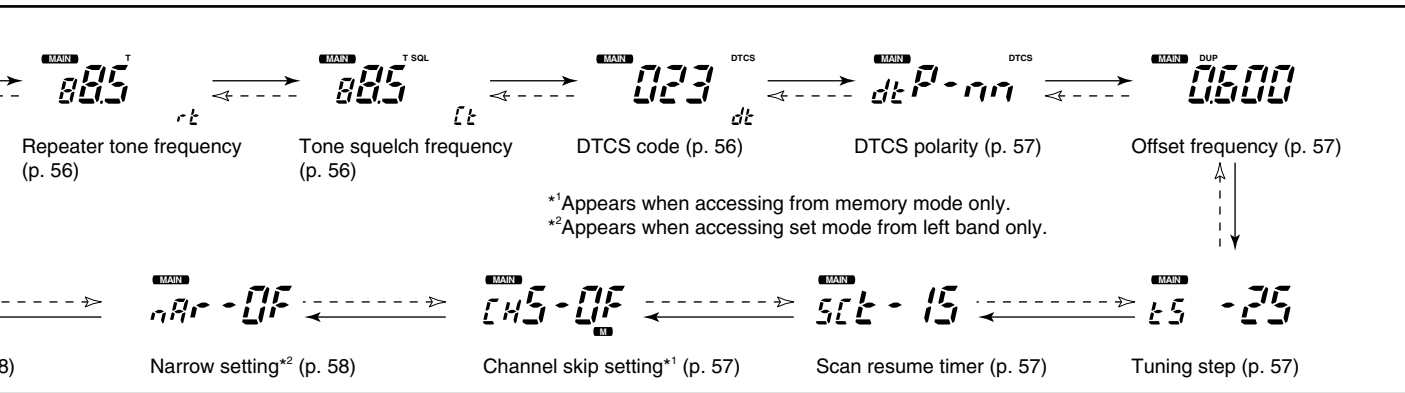
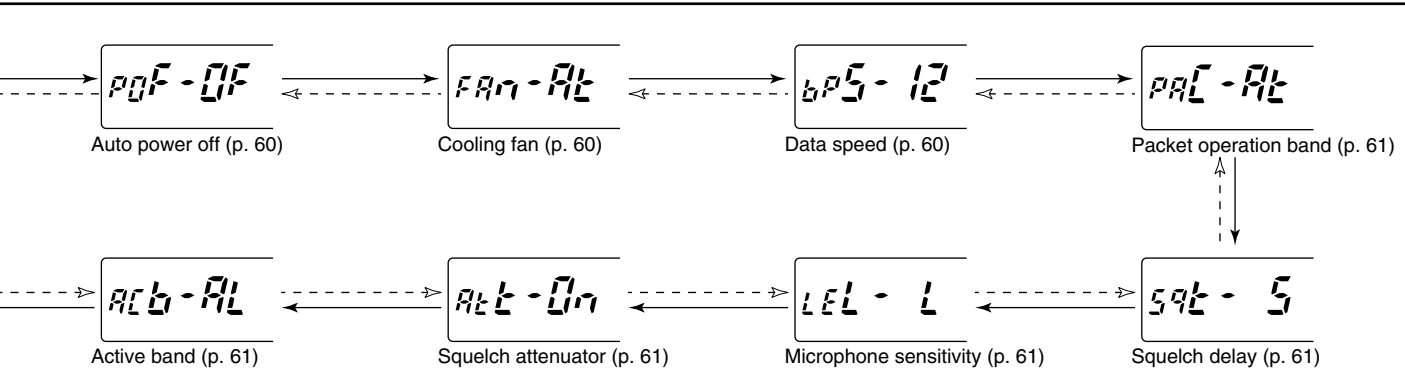



We Icom Inc. Japan
1-1-32, Kamiminami, Hirano-ku
Osaka 547-0003, Japan

Declare on our sole responsibility that this equipment complies with the essential requirements of the Radio and Telecommunications Terminal Equipment Directive, 1999/5/EC, and that any applicable Essential Test Suite measurements have been performed.

Kind of equipment: DUAL BAND FM TRANSCEIVER

Type-designation: IC-2725E

Version (where applicable): _____

This compliance is based on conformity with the following harmonised standards, specifications or documents:

- i) Article 3.1a EN 60950: 1992+A11
- ii) Article 3.1b EN 301489-1 and EN 301489-15
- iii) Article 3.2 EN 301 783-2
- iv) _____
- v) _____

DECLARATION OF CONFORMITY



Düsseldorf 20 Sep. 2002
Place and date of issue

Icom (Europe) GmbH
Himmelgeister straÙe 100
D-40225 Düsseldorf

Authorized representative name
T. Maebayashi
General Manager

Signature

Icom Inc.

Count on us!

#02 Europe

<Intended Country of Use>			
<input checked="" type="checkbox"/> GER	<input checked="" type="checkbox"/> FRA	<input checked="" type="checkbox"/> ESP	<input checked="" type="checkbox"/> SWE
<input checked="" type="checkbox"/> AUT	<input checked="" type="checkbox"/> NED	<input checked="" type="checkbox"/> POR	<input checked="" type="checkbox"/> DEN
<input checked="" type="checkbox"/> GBR	<input checked="" type="checkbox"/> BEL	<input type="checkbox"/> ITA	<input checked="" type="checkbox"/> FIN
<input checked="" type="checkbox"/> IRL	<input checked="" type="checkbox"/> LUX	<input checked="" type="checkbox"/> GRE	<input checked="" type="checkbox"/> SUI

#03 Italy

<Intended Country of Use>			
<input type="checkbox"/> GER	<input type="checkbox"/> FRA	<input type="checkbox"/> ESP	<input type="checkbox"/> SWE
<input type="checkbox"/> AUT	<input type="checkbox"/> NED	<input type="checkbox"/> POR	<input type="checkbox"/> DEN
<input type="checkbox"/> GBR	<input type="checkbox"/> BEL	<input checked="" type="checkbox"/> ITA	<input type="checkbox"/> FIN
<input type="checkbox"/> IRL	<input type="checkbox"/> LUX	<input type="checkbox"/> GRE	<input type="checkbox"/> SUI