

KENWOOD

TS-850 series

Service Manual Schematic

KENWOOD CORPORATION



TS-850S PC BOARD VIEWS

DC-DC (X59-1100-00) Component side view

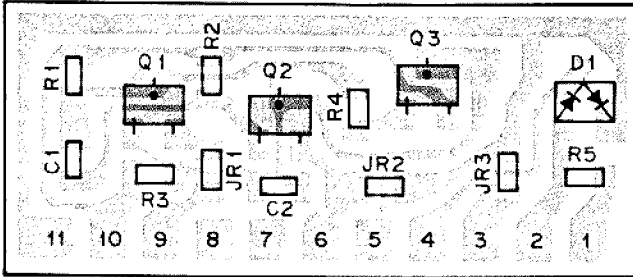

SN74LS145N

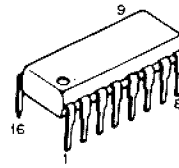

TC4538BF

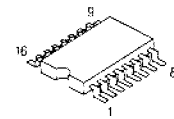

- 2SA1162(Y)
- 2SC2712(Y)
- 2SC2714(Y)
- 2SD1757K
- DTA124EK
- DTA144EK
- DTA143TK
- DTC124EK
- DTC114EK
- DTC143TK



FM MIC (X59-3000-03) Component side view

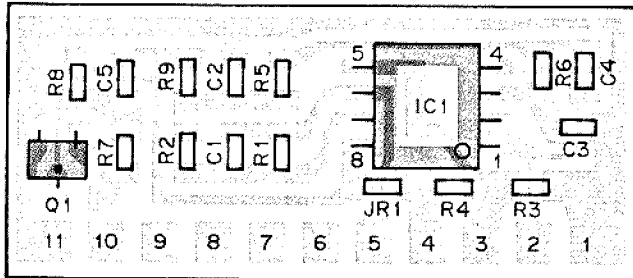

μPC1037HA

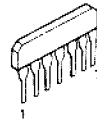

TC9174F

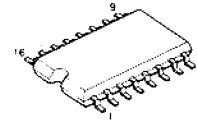

- 2SA1213(Y)
- 2SC2954(QK)

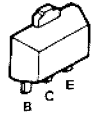

AIP SW (X59-3900-00) Component side view

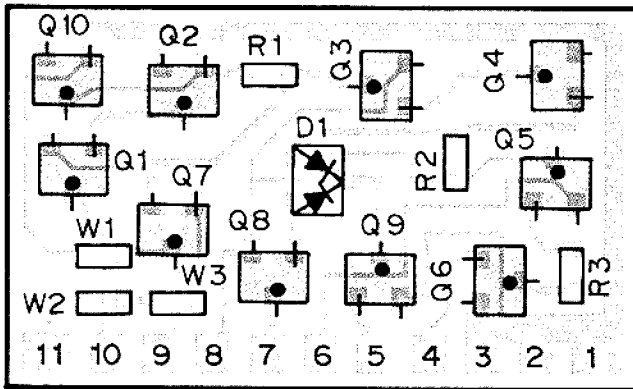

NJM2902M

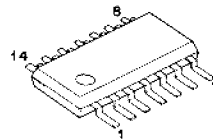

2SK125-5

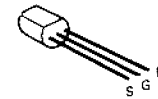

2SD1624S



TC4011BP

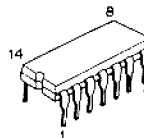

- 2SK208(GR)
- 2SK520(K44)



NJM4558M

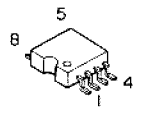

NB2 (X59-3910-00) Component side view

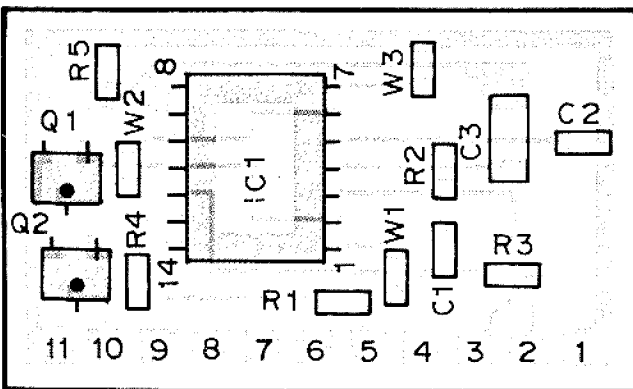

TC4011BF
TC4066BF

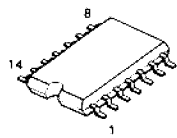

3SK131(M)

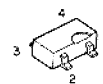

RF UNIT (X44-3120-00) Component side view

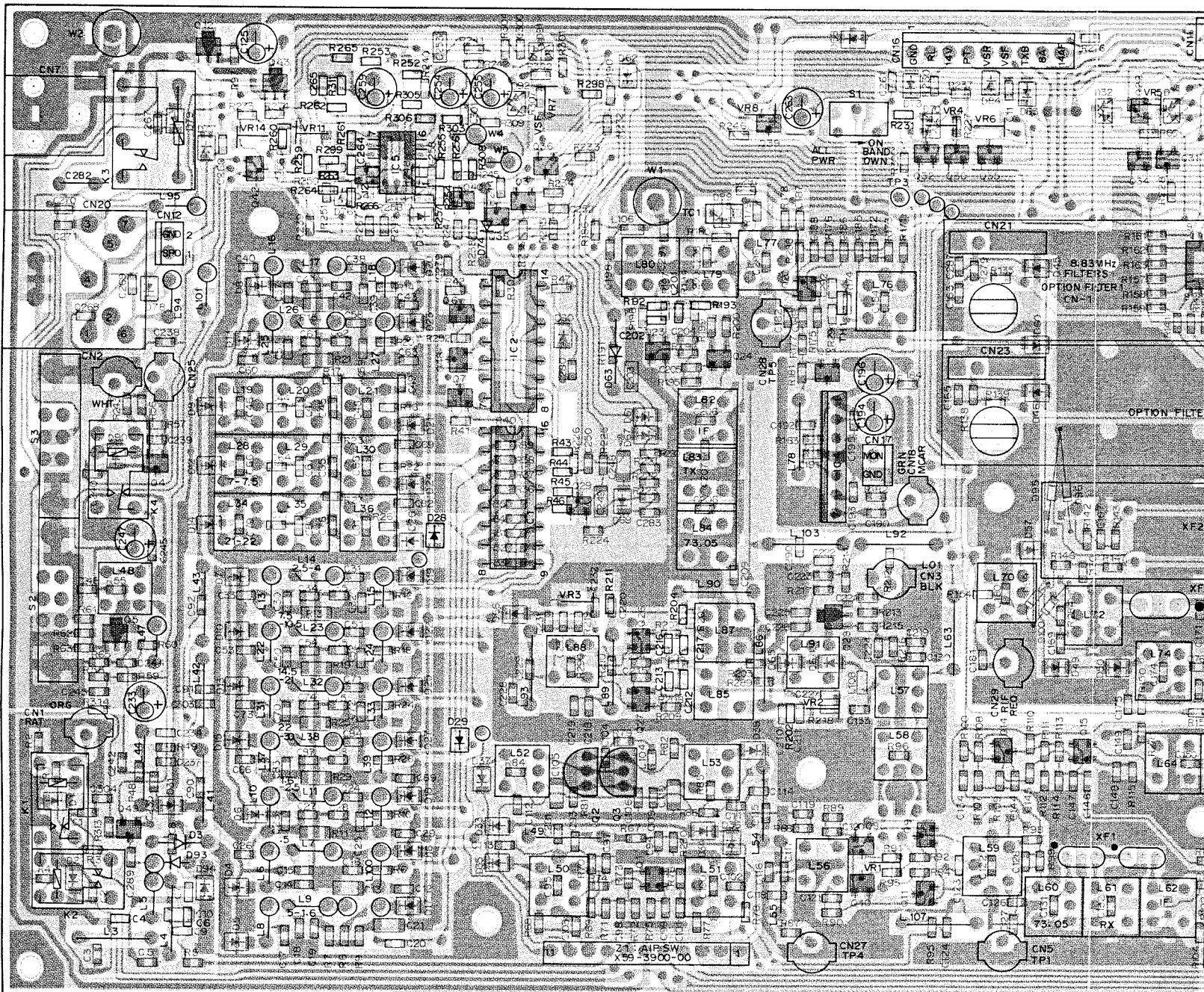

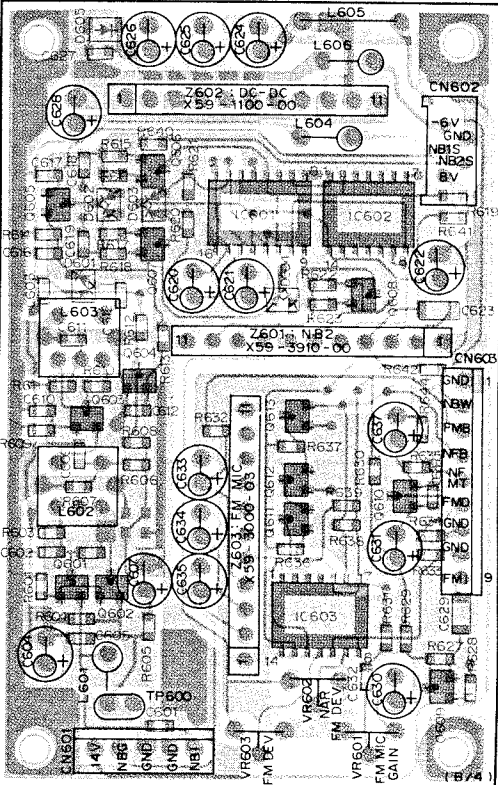
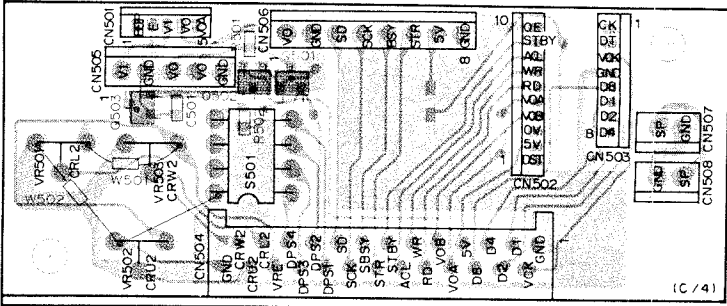
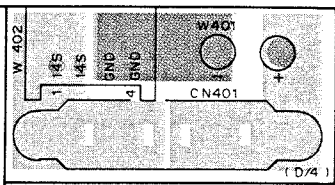
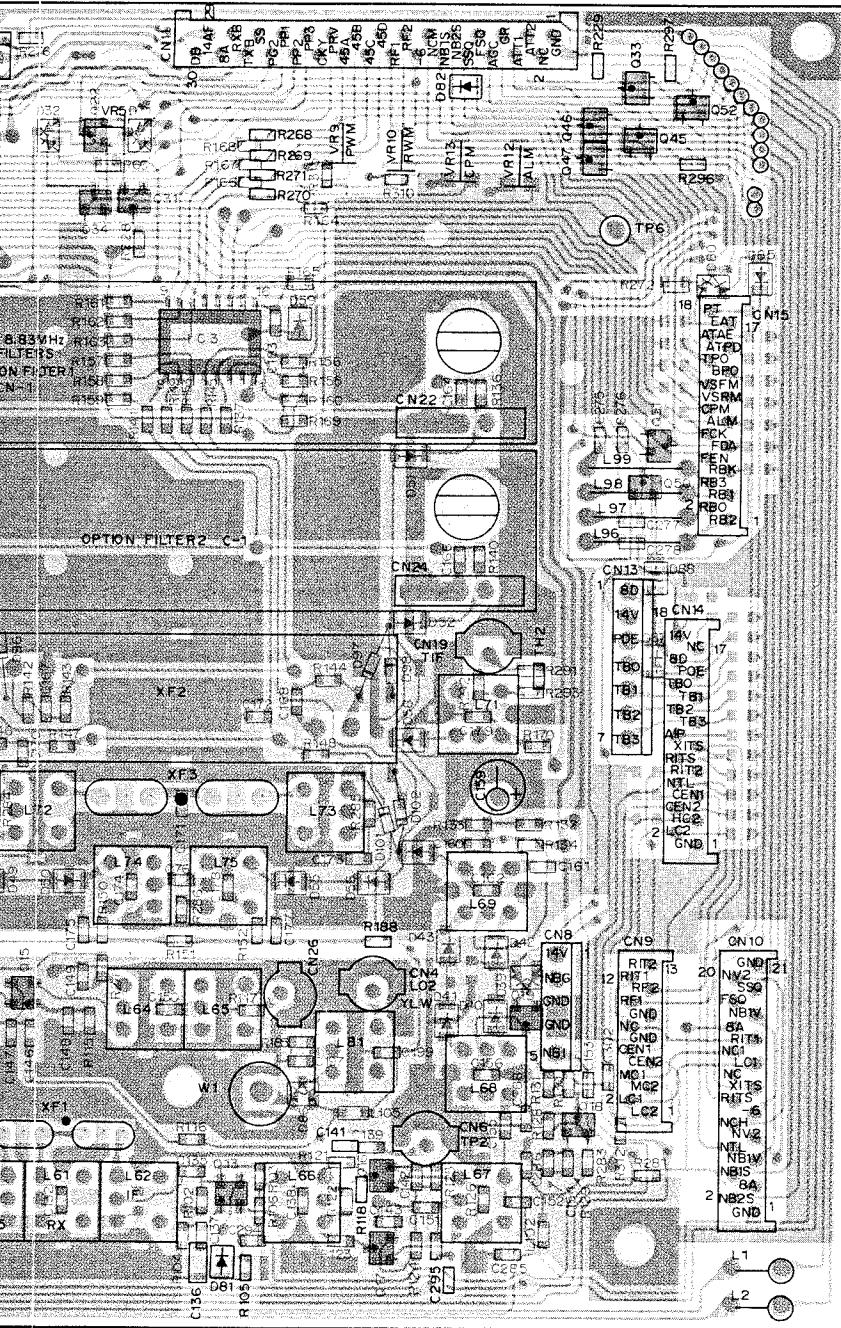

RF UNIT (X44-3120-00) Foil side view

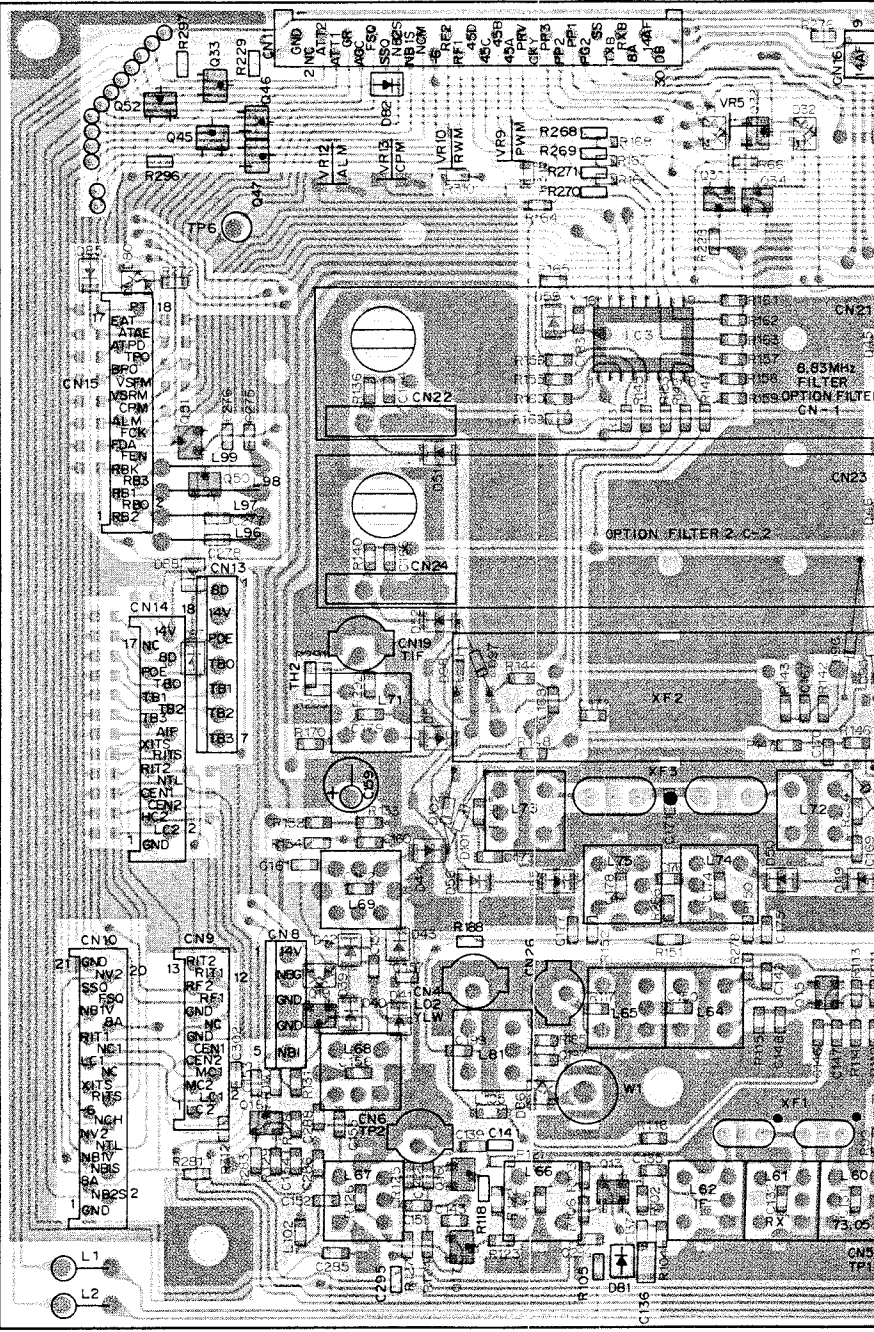
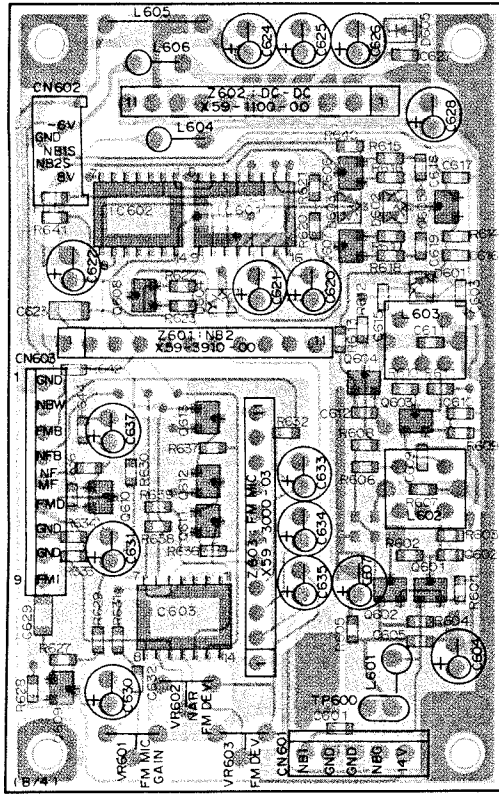
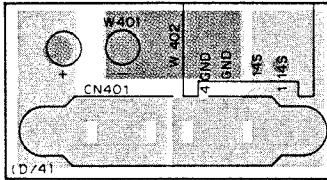
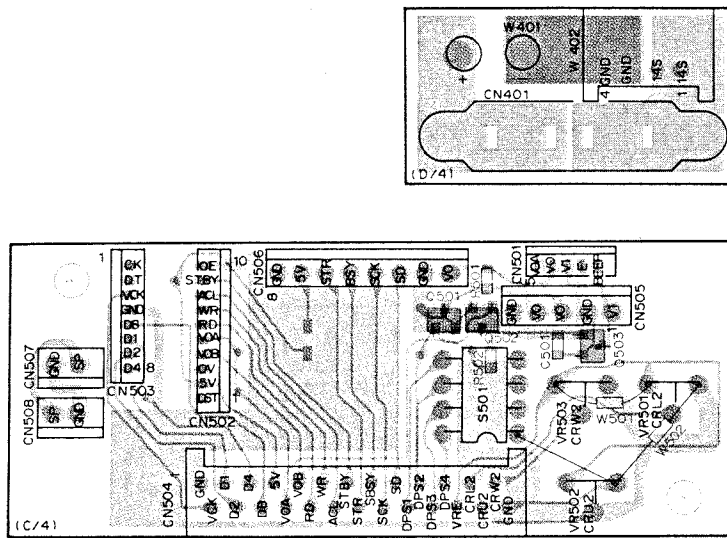

PC BOARD VIEWS TS-850

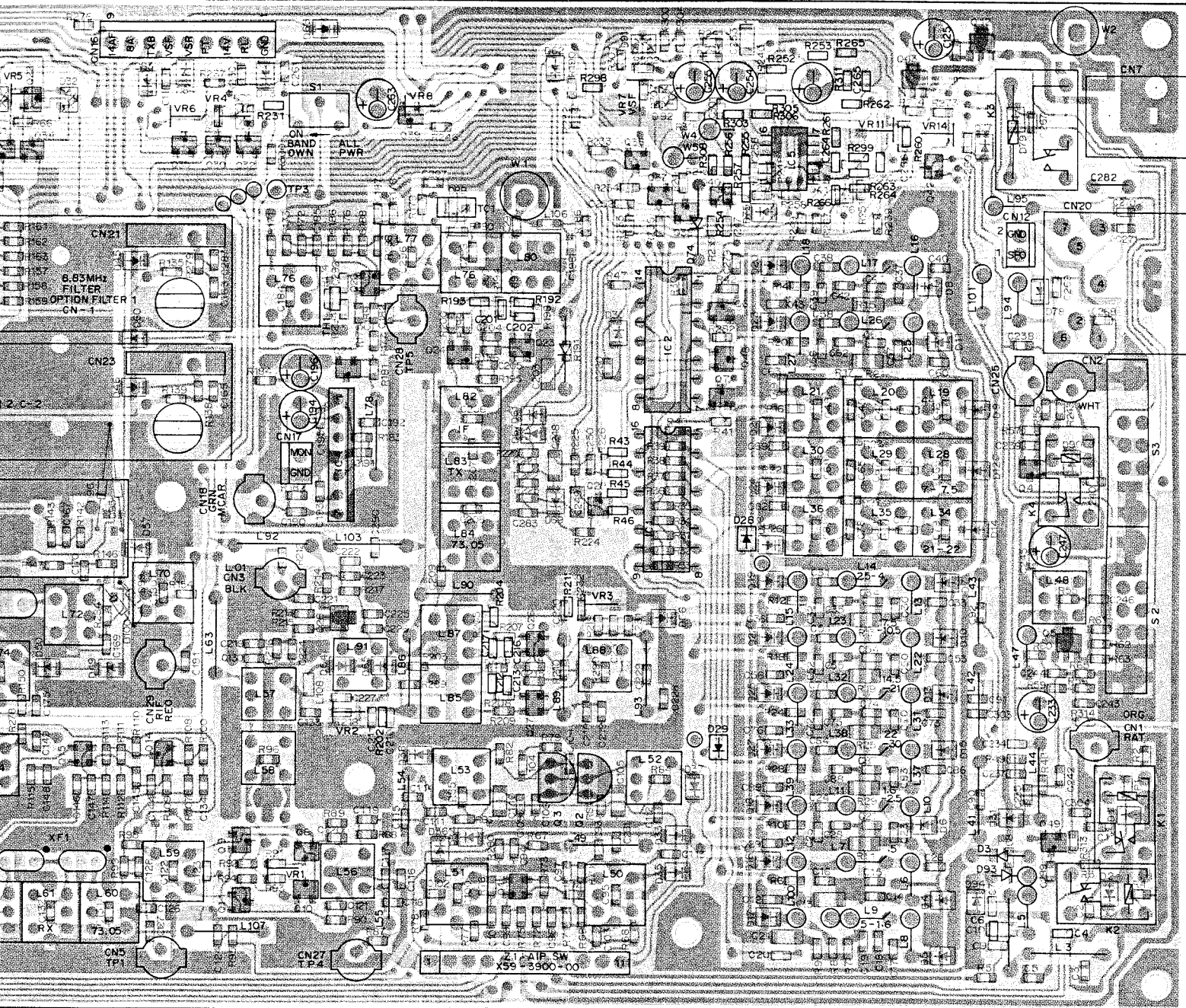

TS-850S CIRCUIT DIAGRAM

RF UNIT (X44-3120-00)

RF UNIT (X44-3120-00) (A/4)

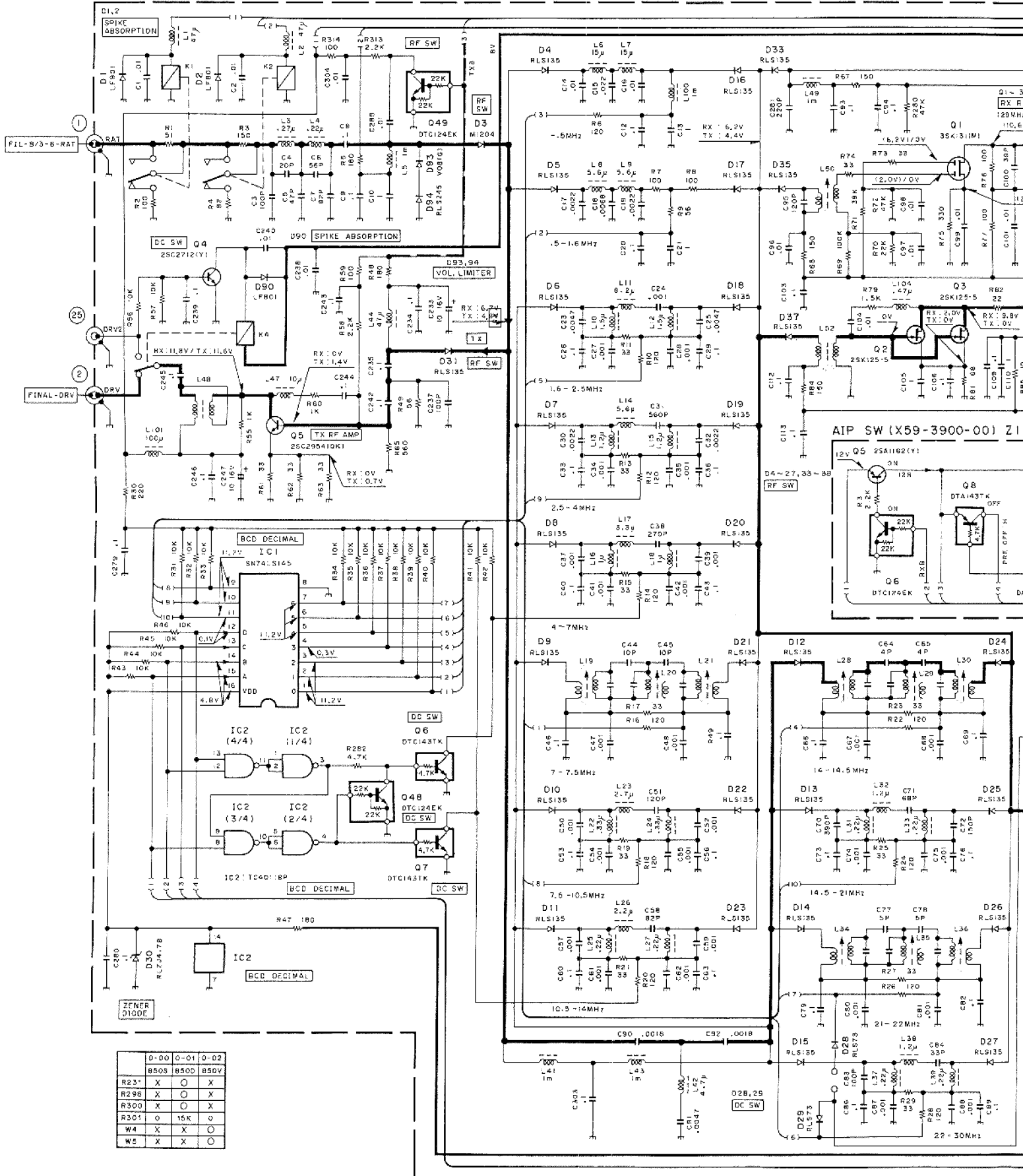

	0-0.0	0-0.1	0-0.2
R23*	X	○	X
R29*	X	○	X
R30*	X	○	X
R30†	○	15K	○
W4	X	X	○
W5	X	X	○

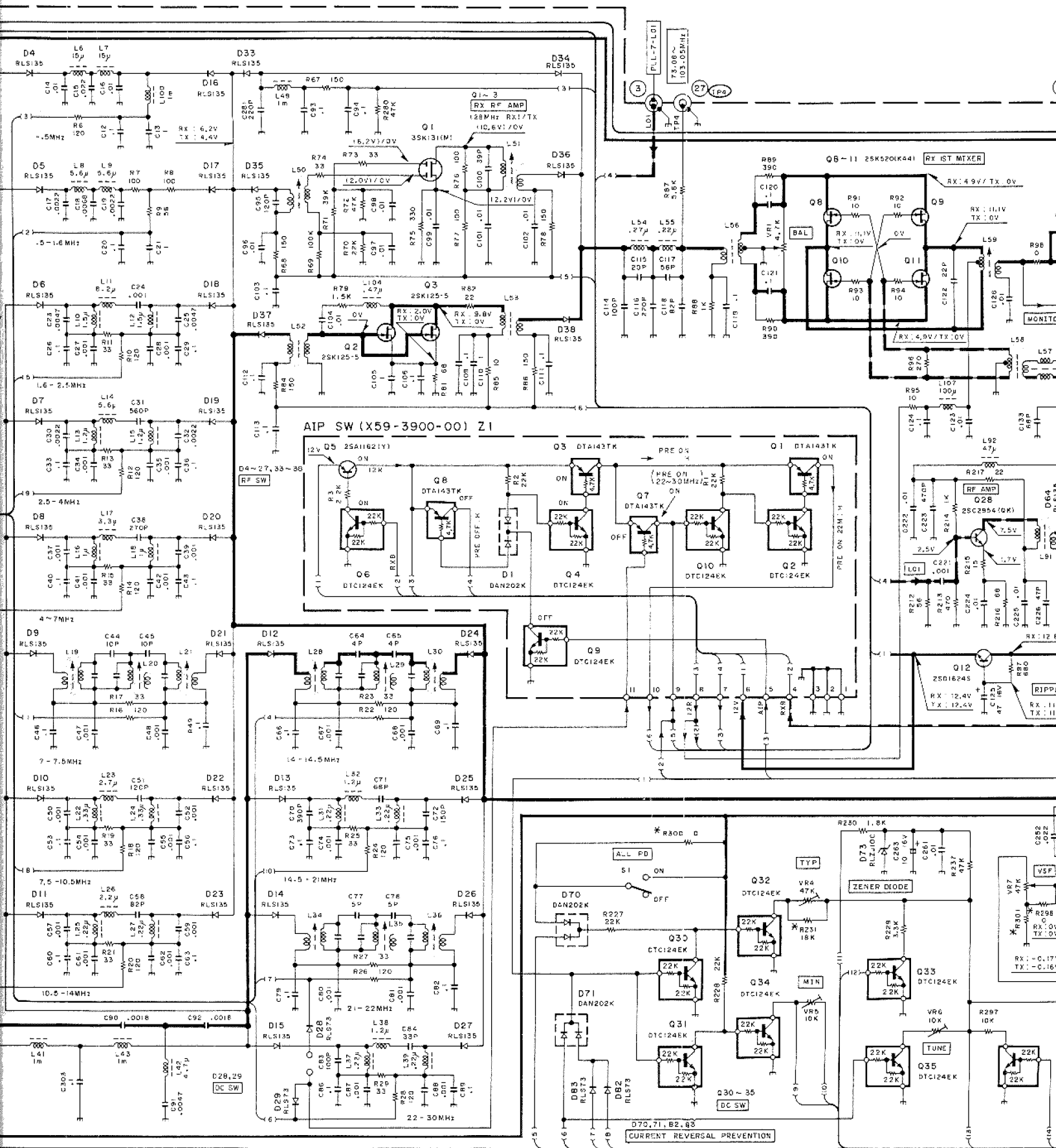

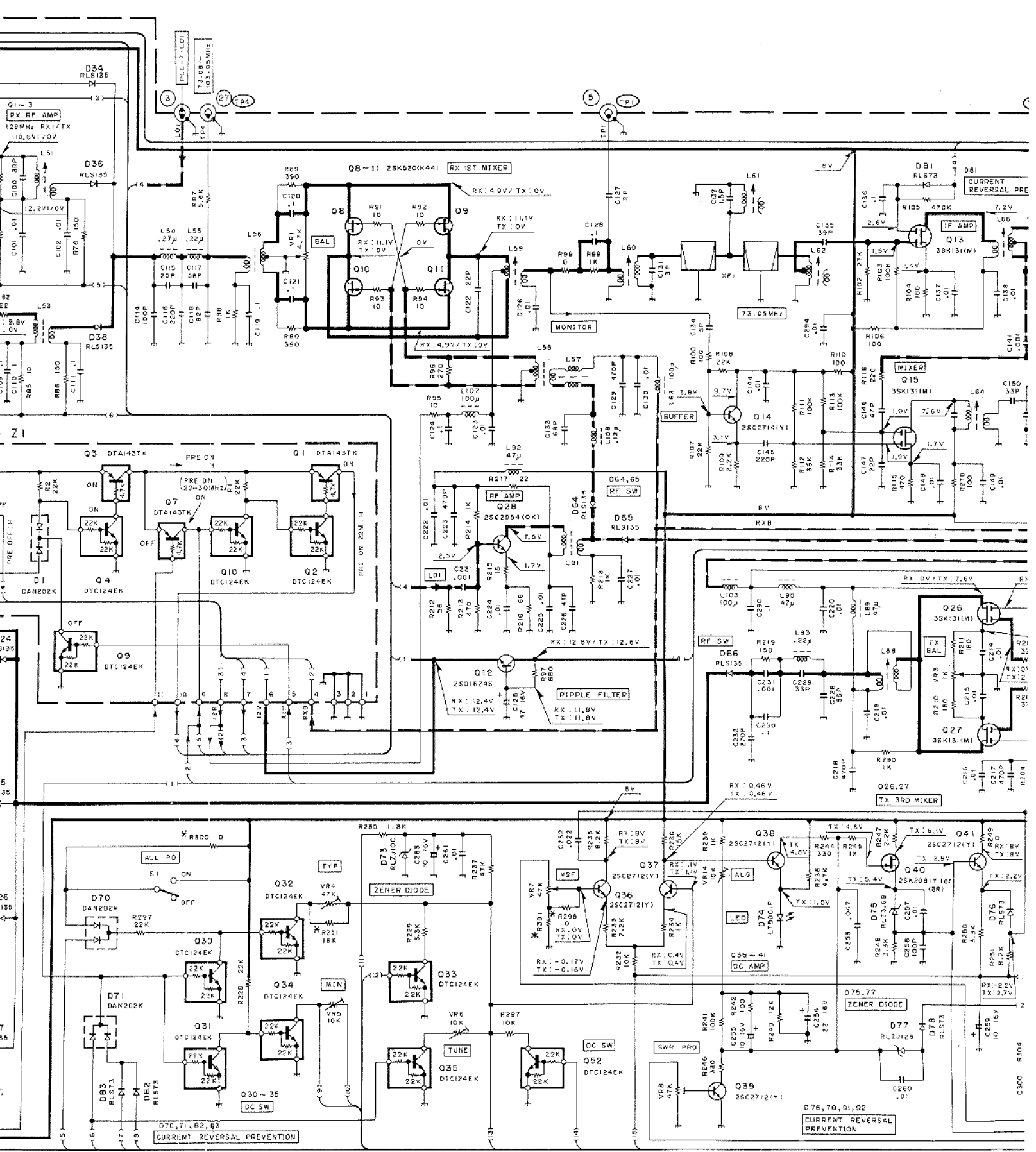

Q1-3
RX RF AMP
128MHz RX1/TX
(10,6V/0V)

Q8-11 25K520K441
RX 1ST MIXER
RX: 4.9V/TX: 0V

DB1
CURRENT REVERSAL PREC
7.2V

IF AMP
Q13
35K131(M)

MIXER
Q15
35K131(M)

RF AMP
Q2B
25C2954(OX1)

Q12
25D16245
RX: 12.4V/TX: 12.4V

RIPPLE FILTER
RX: 1.9V/TX: 11.8V

Q26
35K131(M)

Q27
35K131(M)

Q26,27
TX 3RD MIXER

ZENER DIODE
D73
R230 1.8K

Q37
25C2712(Y)

Q36
25C2712(Y)

Q38
25C2712(Y)

Q39
25C2712(Y)

ZENER DIODE
D76,77
R231 8.2K

CURRENT REVERSAL PREVENTION
D76,78,81,92

CURRENT REVERSAL PREVENTION
D76,77,82,83

C300

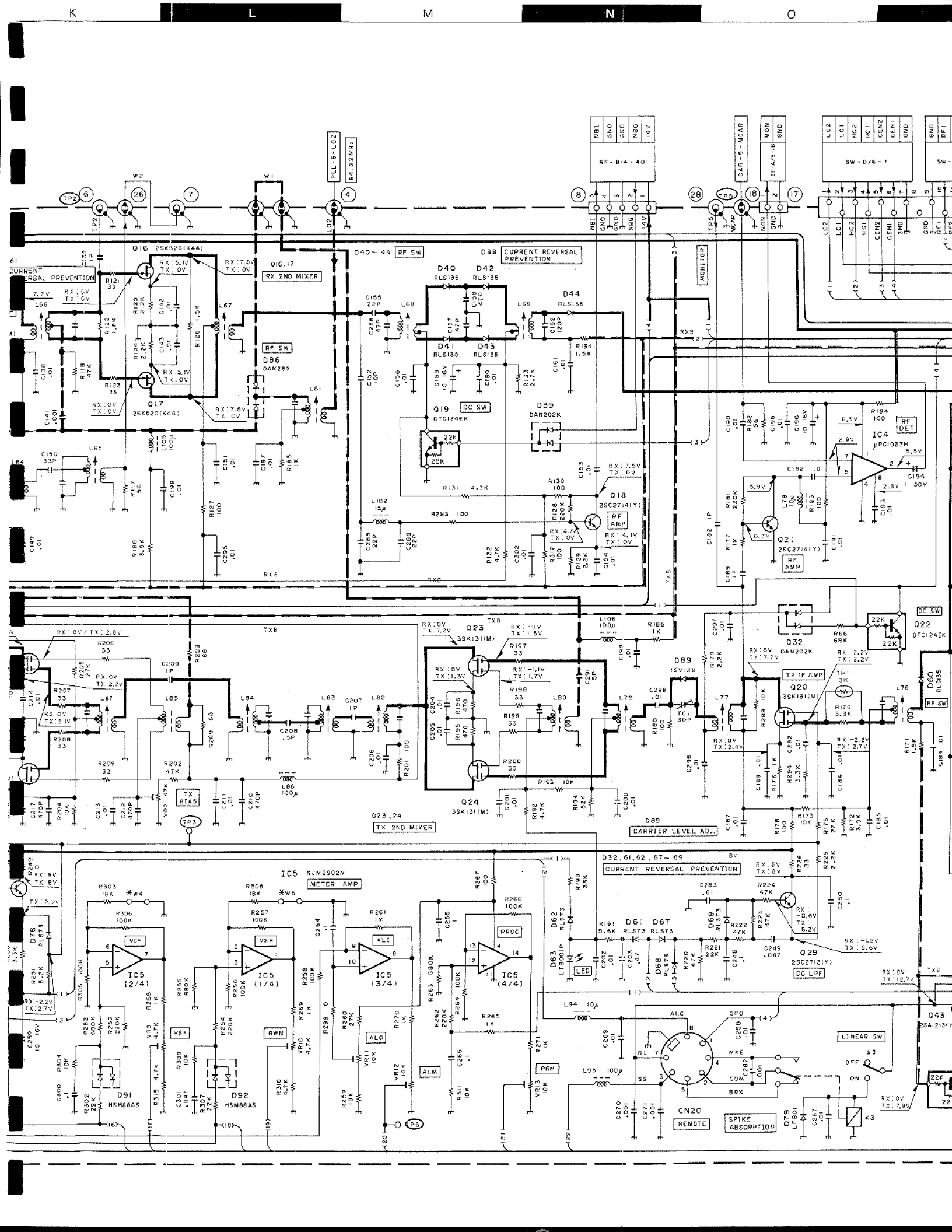

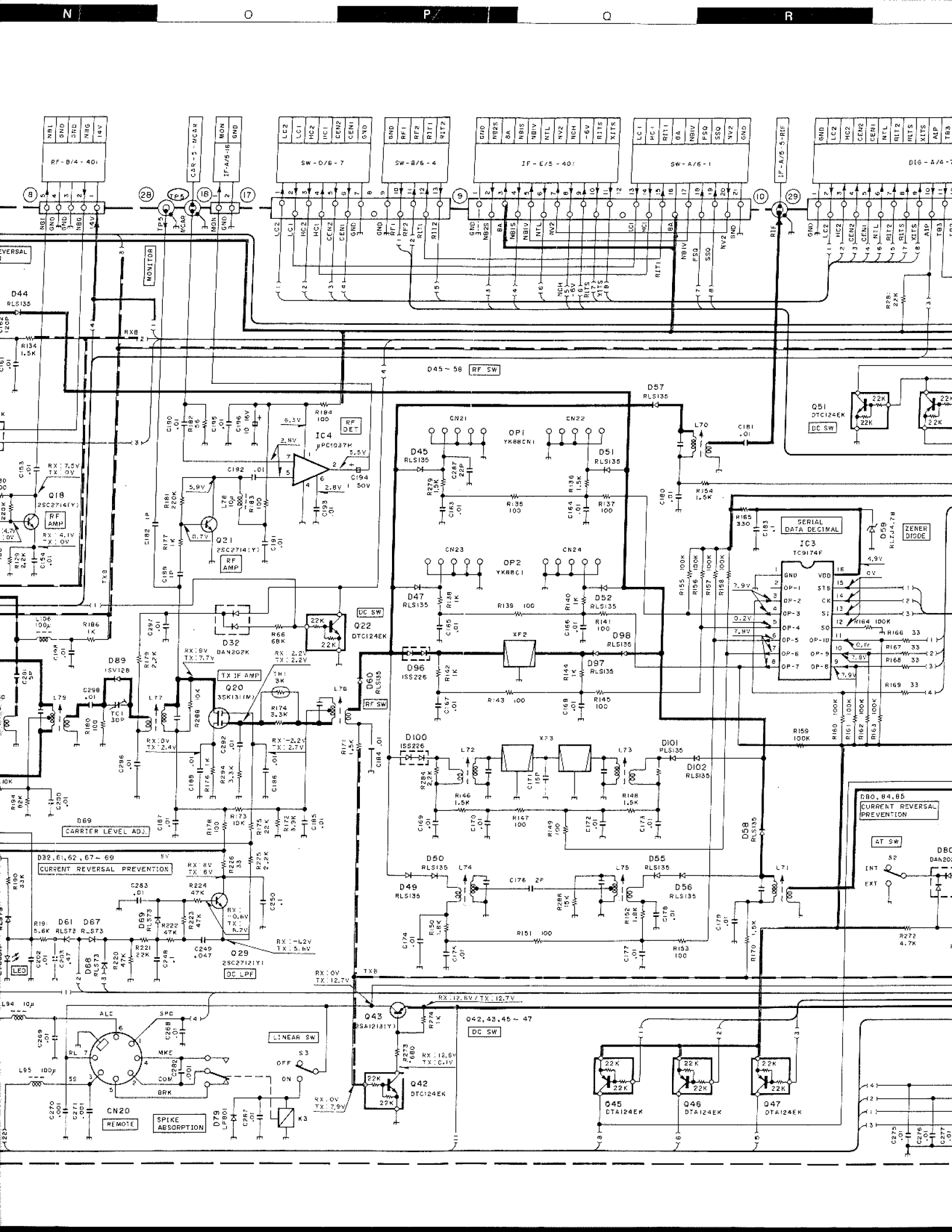

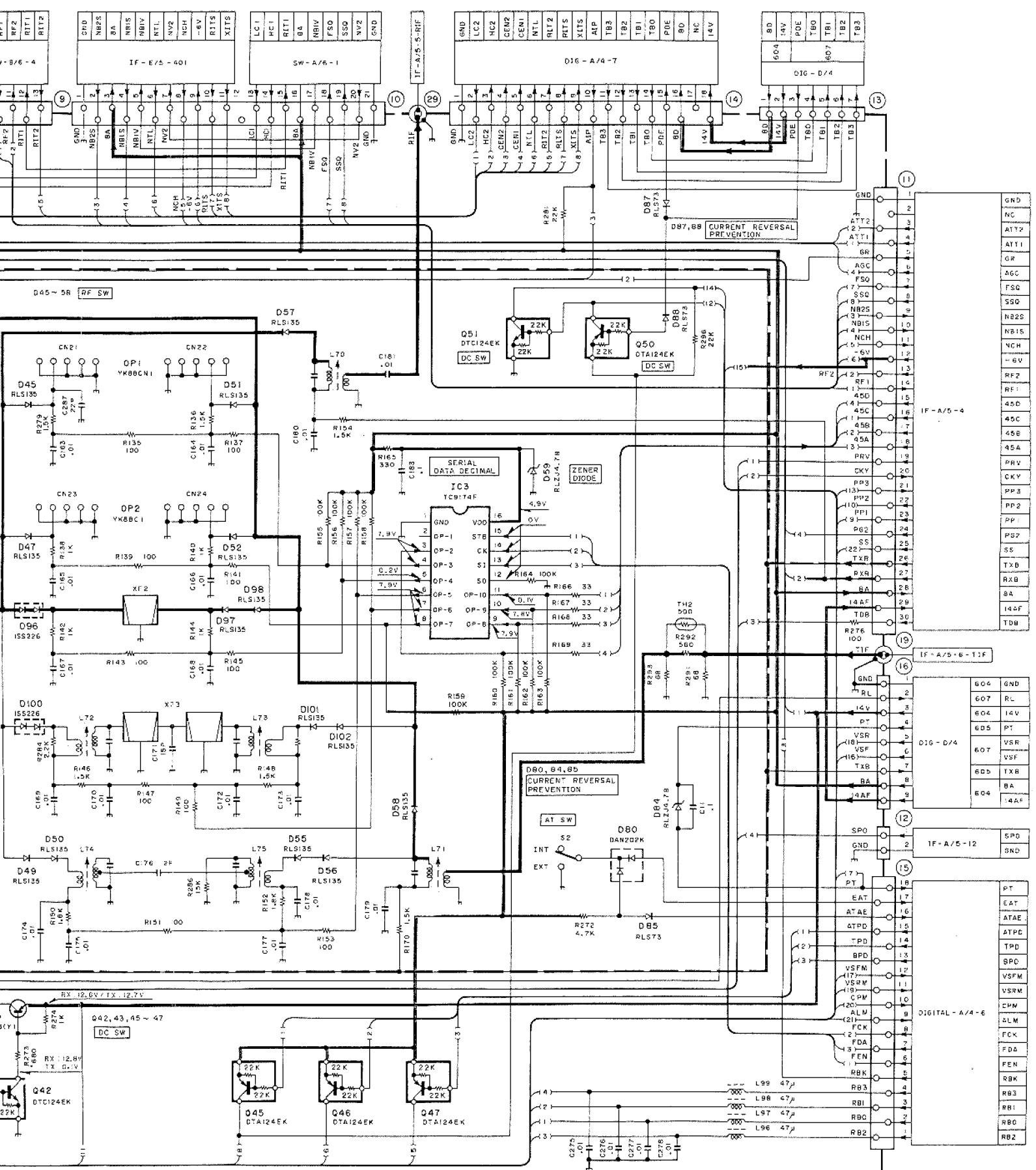

GND	GND
NC	NC
ATT2	ATT2
GR	GR
AGC	AGC
FSQ	FSQ
SSQ	SSQ
NB25	NB25
NBIS	NBIS
NCH	NCH
-6V	-6V
RF2	RF2
RF1	RF1
45D	45D
45C	45C
45B	45B
45A	45A
PRV	PRV
CKY	CKY
PP3	PP3
PP2	PP2
PP1	PP1
PG2	PG2
SS	SS
TXR	TXR
TXB	TXB
BA	BA
14AF	14AF
TDB	TDB

GND	GND
RL	RL
14V	14V
PT	PT
VSR	VSR
VSF	VSF
TXR	TXR
BA	BA
14AF	14AF

604	GND
607	RL
604	14V
605	PT
607	VSR
605	VSF
605	TXR
604	BA
604	14AF

SPD	SPD
SRD	SRD
PT	PT
EAT	EAT
ATAE	ATAE
ATPD	ATPD
TPD	TPD
SPQ	SPQ
VSRM	VSRM
VSRM	VSRM
CWM	CWM
ALM	ALM
FCX	FCX
FDA	FDA
FEN	FEN
RBK	RBK
RB3	RB3
RB1	RB1
RBQ	RBQ
RB2	RB2

604	GND
607	RL
604	14V
605	PT
607	VSR
605	VSF
605	TXR
604	BA
604	14AF

RF UNIT (X44-3120-00)

RF UNIT (X44-3120-00) (B/4)

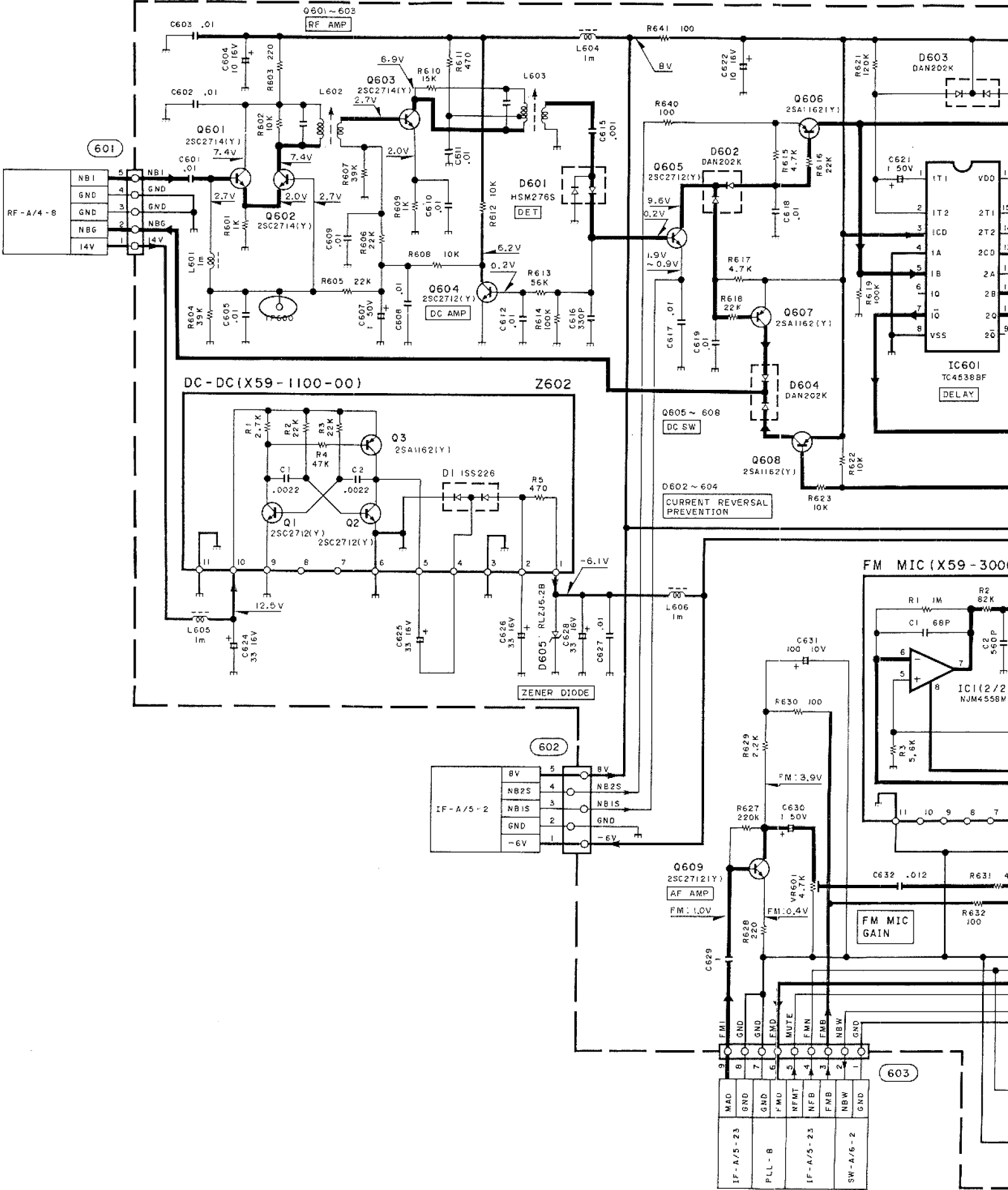

CIRCUIT DIAGRAM TS-850S

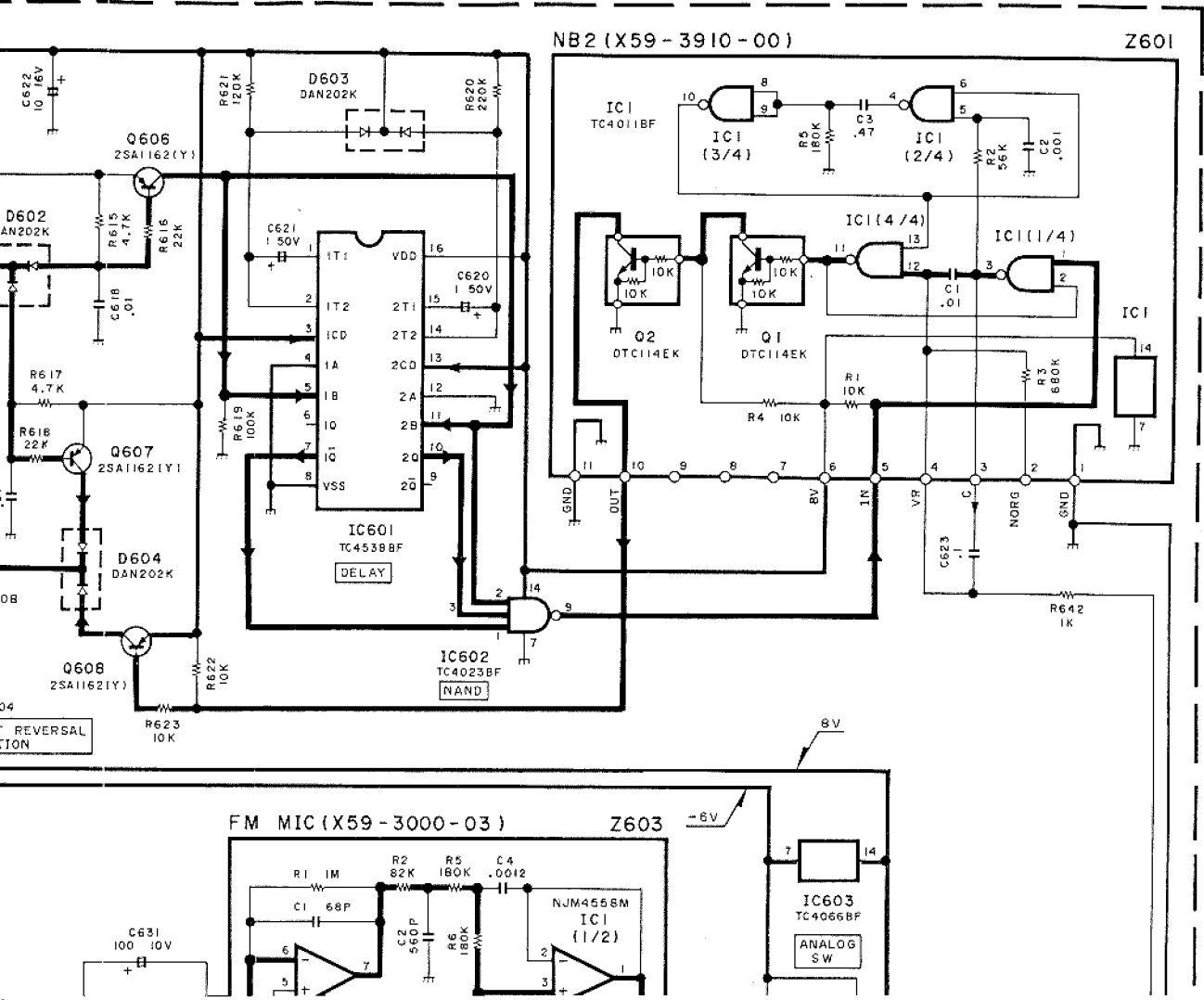

TS-850S CIRCUIT DIAGRAM / PC BOARD VIEW

FINAL UNIT (X45-1470-02) Component side view

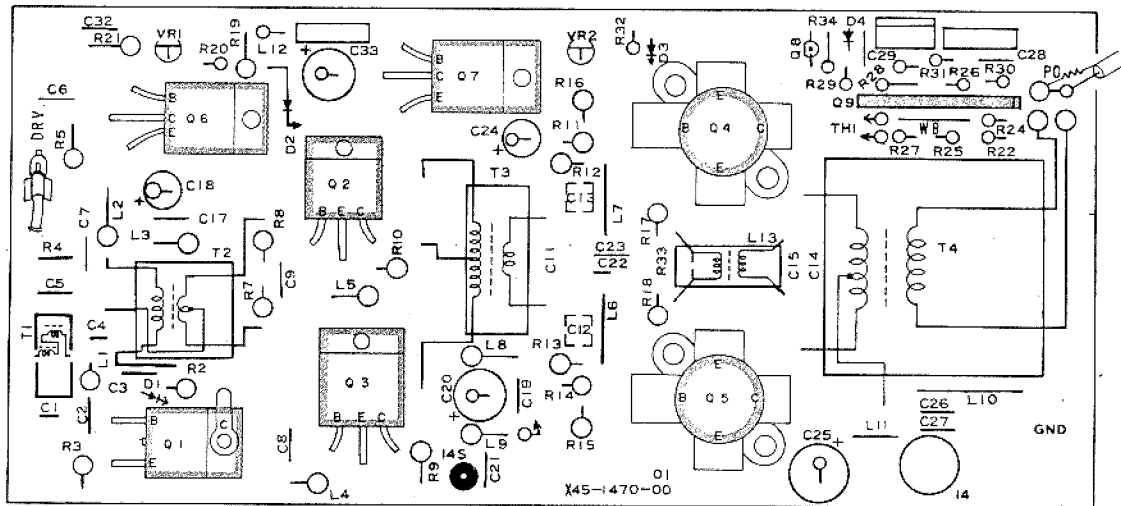

2SC1815(Y)

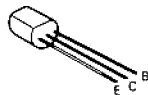

2SC2075

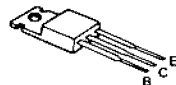

2SC2509

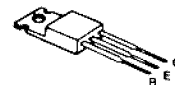

2SC2879

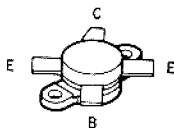

2SD1406(Y)

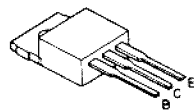

AN6551

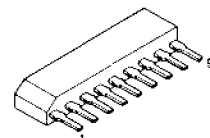

FINAL UNIT (X45-1470-02)

FINAL UNIT (X45-1470-02)

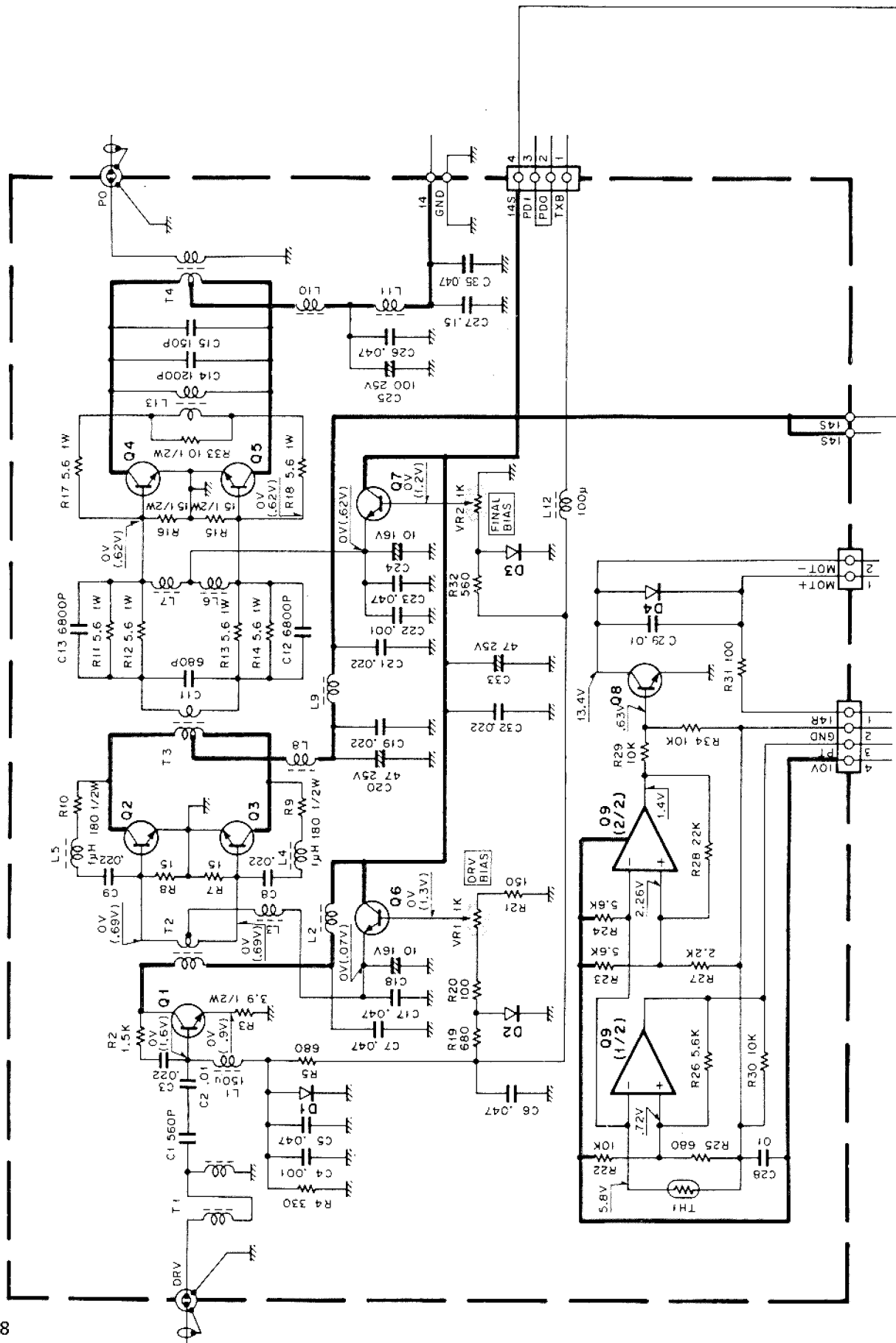

- Q1 : 2SC2075
- Q2,3 : 2SC2509
- Q4,5 : 2SC2879*J
- O6,7 : 2SD1406(Y)
- O8 : 2SC1815(Y)
- O9 : AN6551
- D1 : KB-365
- D2,3 : SV-03YS
- D4 : IS1555 or IN4448

DIGITAL UNIT (X46-308X-XX) Component side view

0-11 : K,K2,P,P2 0-21 : M,M2 0-22 : M3,M4 0-71 : X,X2 2-71 : E,E2 2-72 : E3,E4

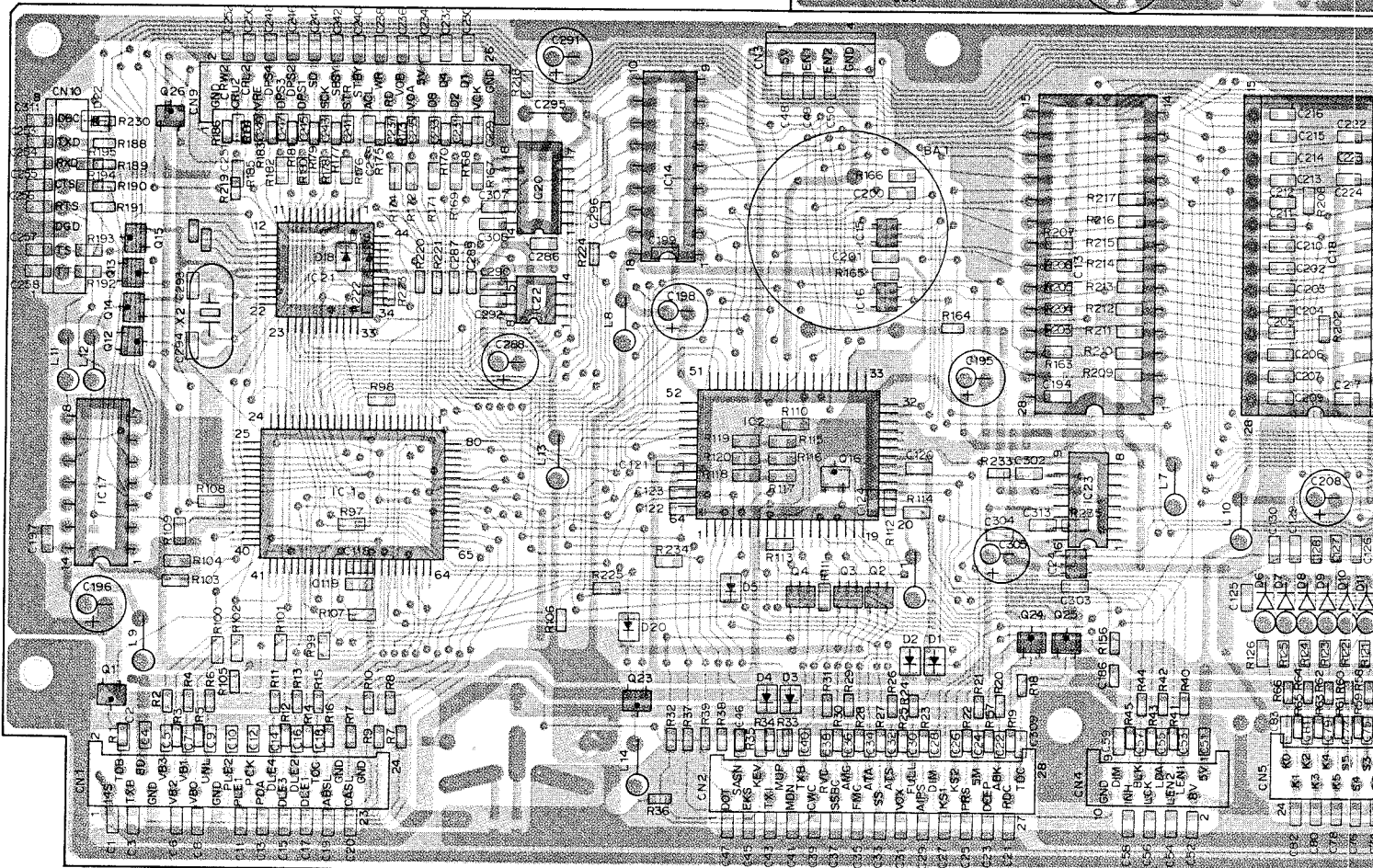
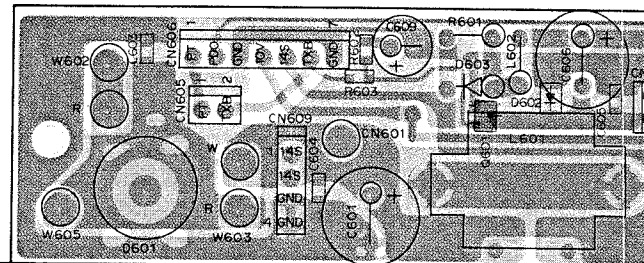
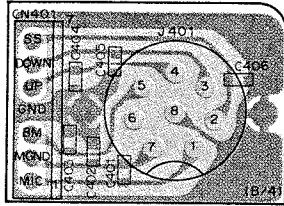

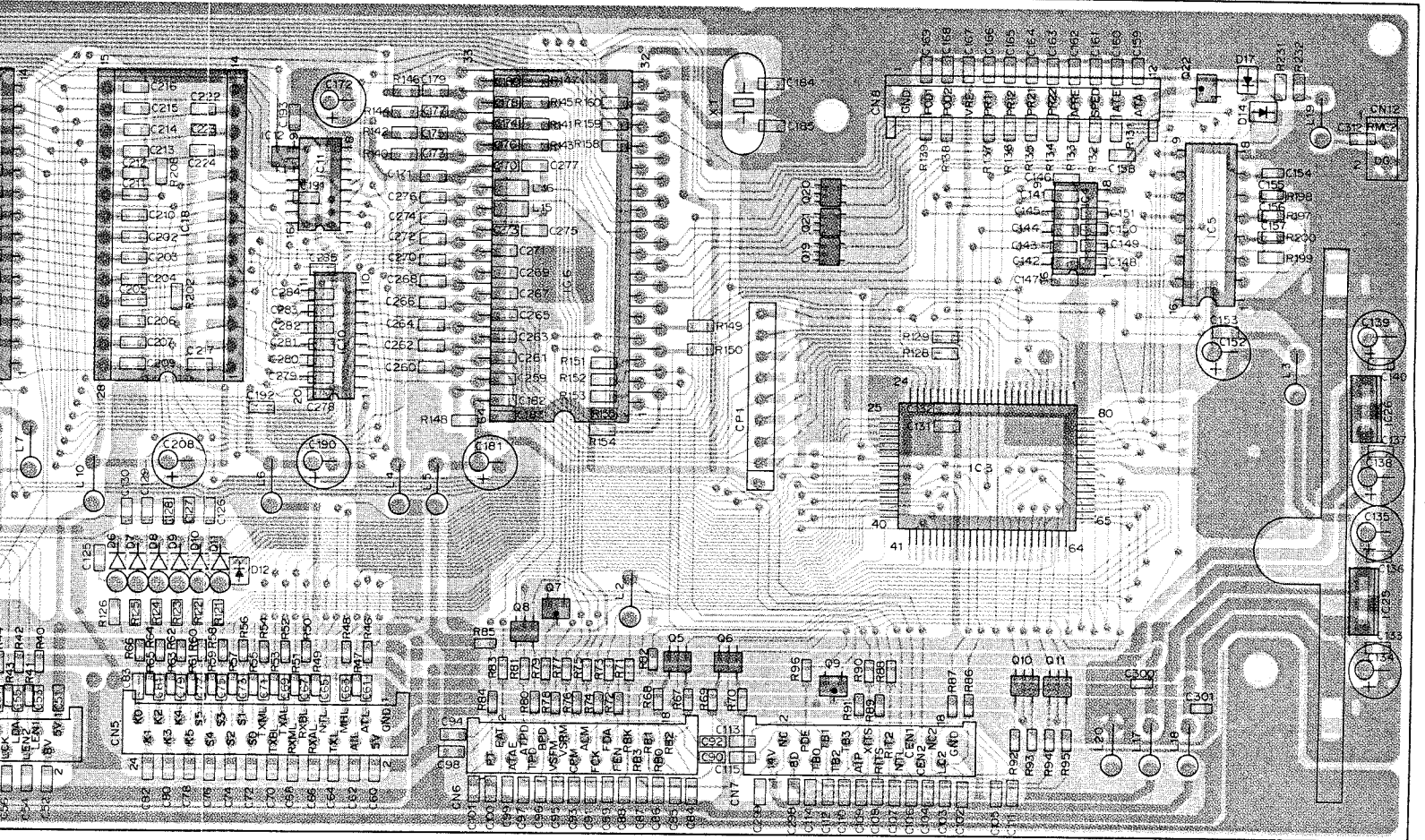
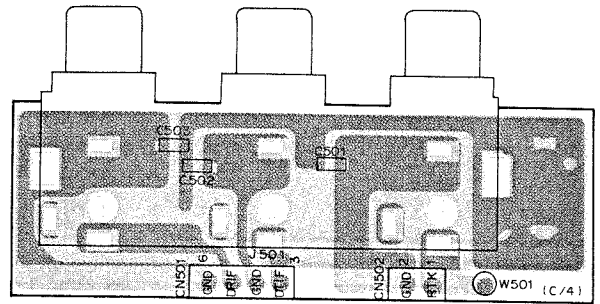
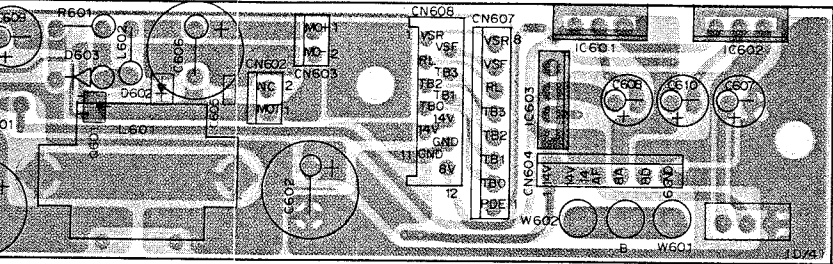

DIGITAL UNIT (X46-308X-XX) Foil side view

0-11 : K,K2,P,P2 0-21 : M,M2 0-22 : M3,M4 0-71 : X,X2 2-71 : E,E2 2-72 : E3,E4

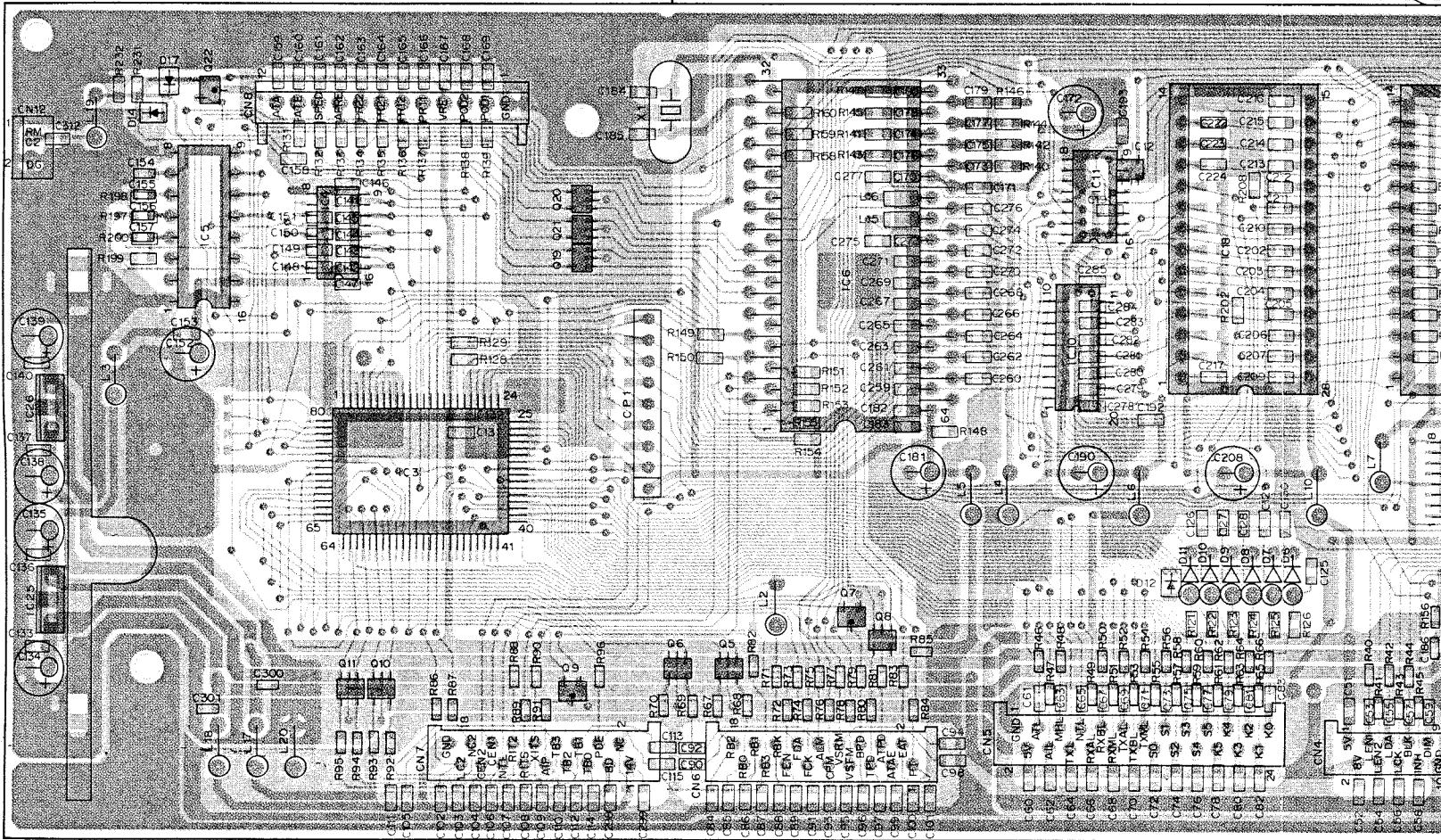
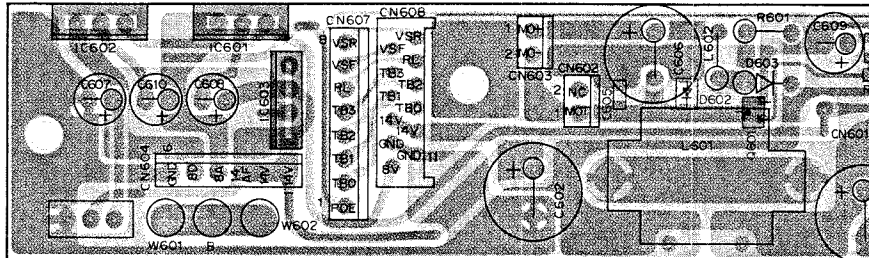
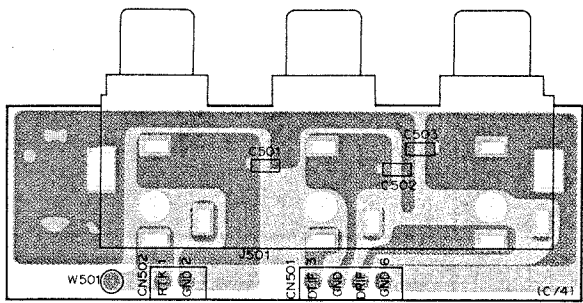

PC BOARD VIEWS TS-850S

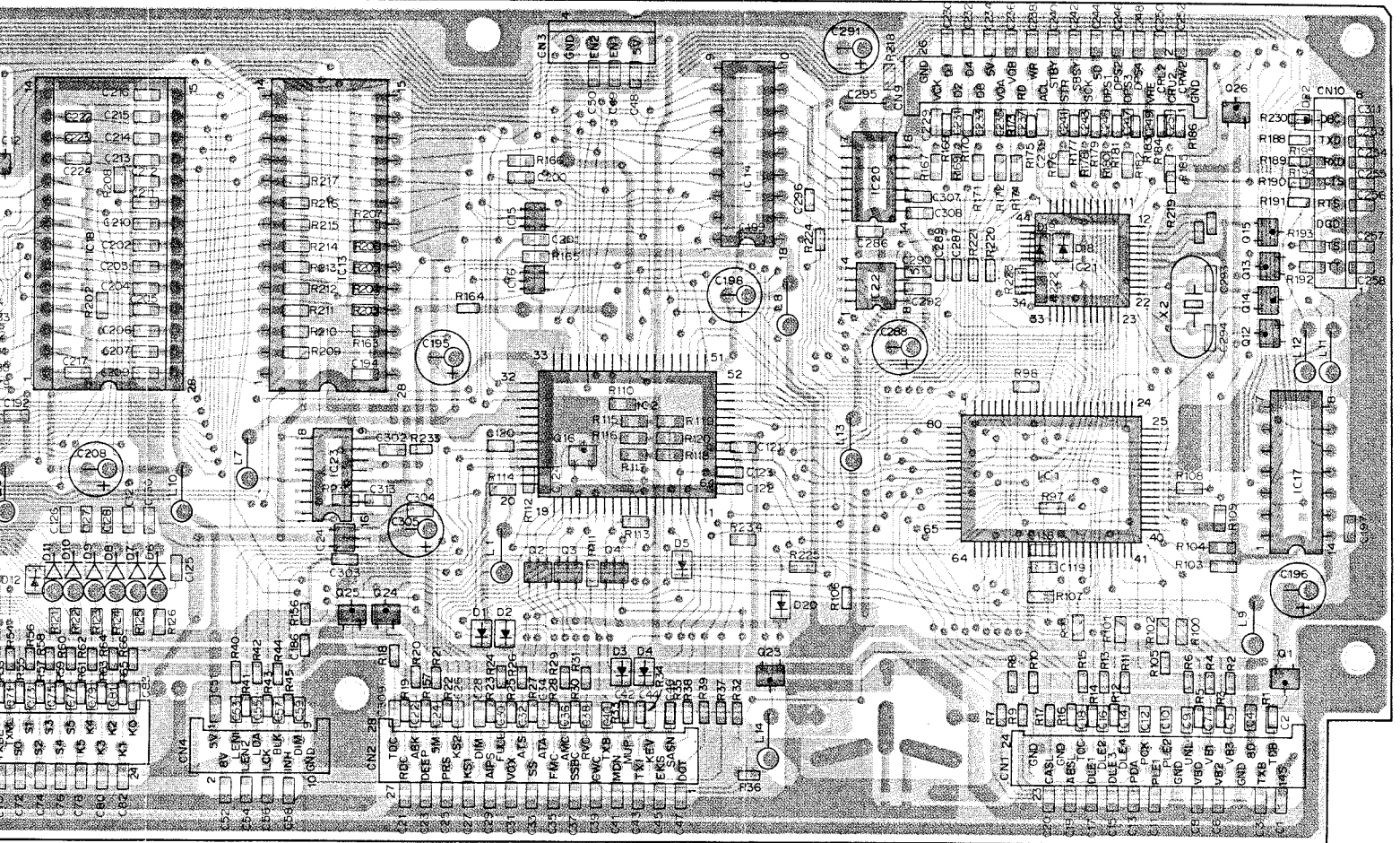
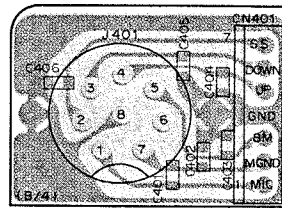
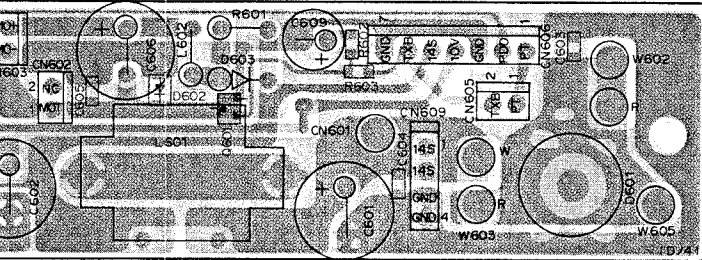

50S CIRCUIT DIAGRAM

DBC	TXD	RXD	CTS	RTS	DGD	T5	TT
FIL-C/3-9							

⑩

GND	CRW2	CRU2	CRL2	VRE	DP34	DP33	DP32	DP31	SD	SCK	SB3V	STR	STBY	ACL	WR	RD	VOB	VGA	SV	DB	D4	D2	D1	YCK	GND
RF-C/4-504																									

⑪

DIGIT



DIGITAL UNIT (X46-308X-XX)(A/4)(1/2)

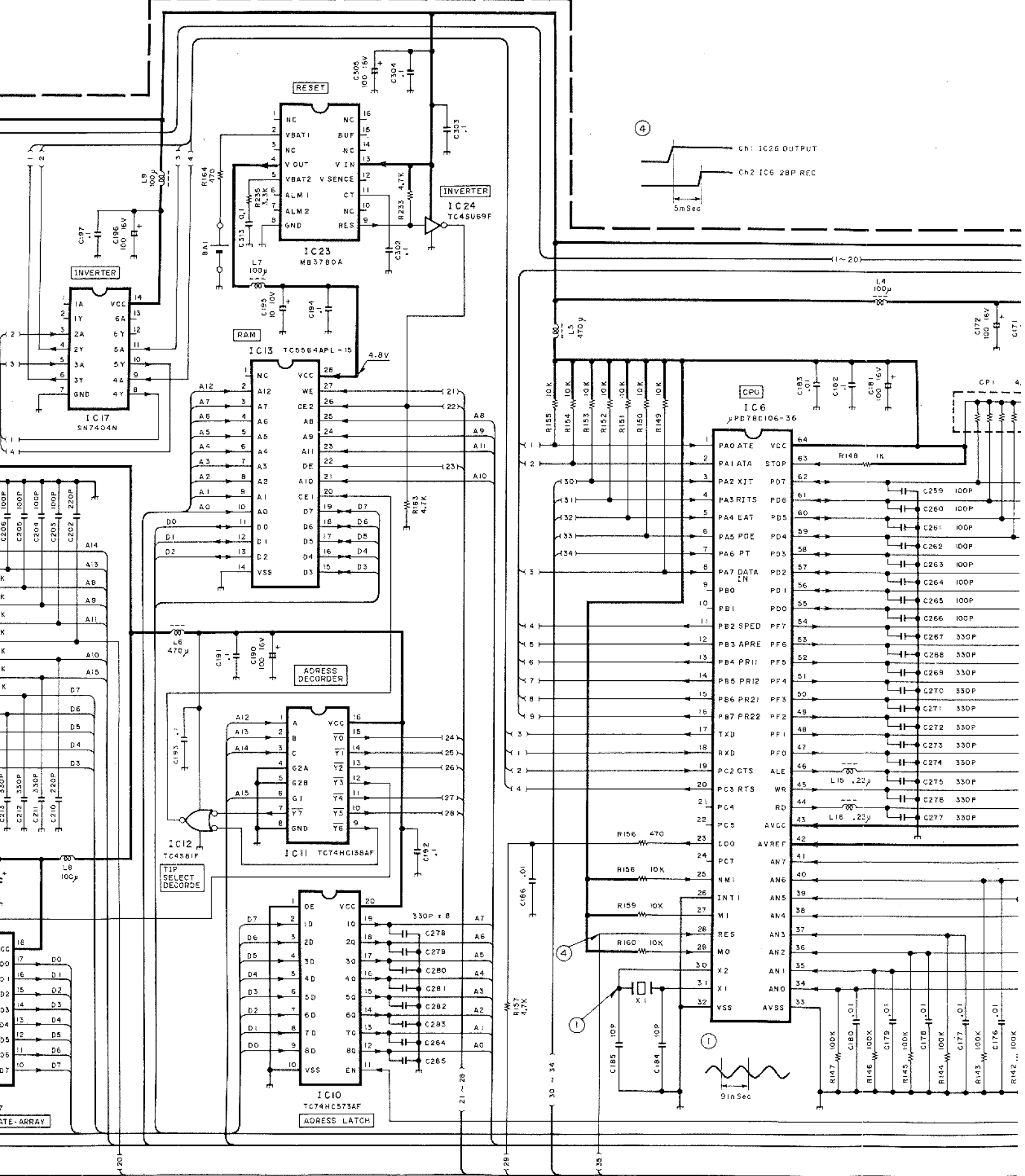

DIGITAL UNIT (X46-308X-XX)

0-11 : K,K2,P,P2 0-21 : M,M2 0-22 : M3,M4 0-71 : X,X2 2-71 : E,E2 2-72 : E3,E4

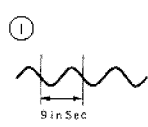
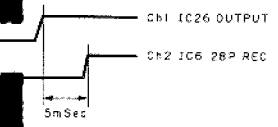
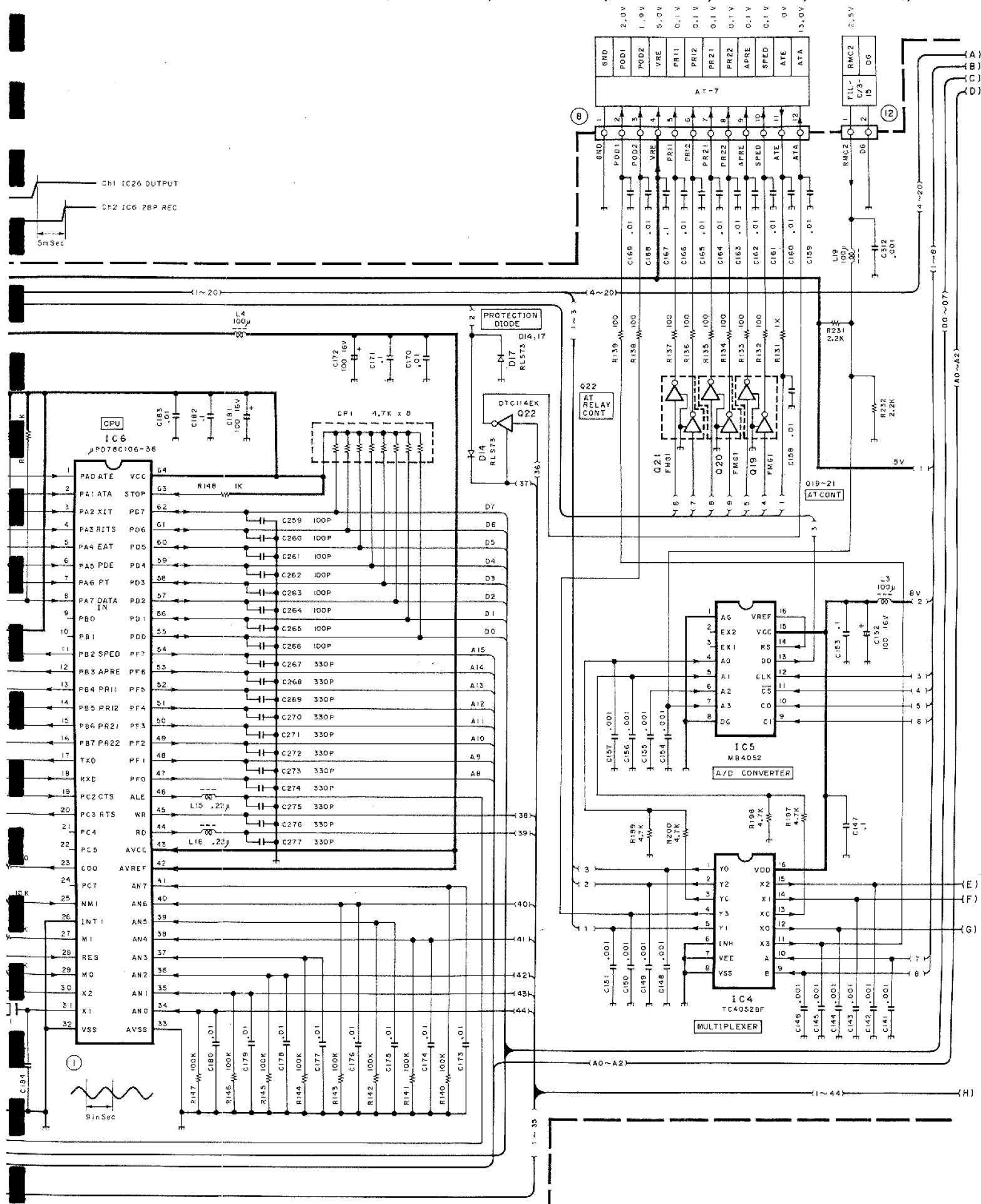

MB4052

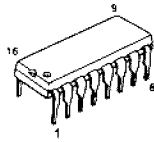

2SC2712(Y)
DTA143EK
DTC114EK
DTC143EK



LA5010

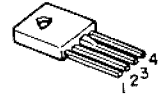

SN7404N

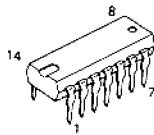

TC4S81F
TC4S584F
TC4SU69F
FMG1

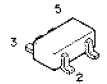

AN78N08

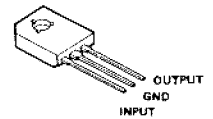

LZ92K37

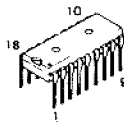

TC74HC573AF

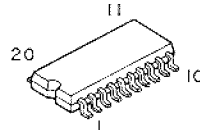

μPC7805H
μPC7808H

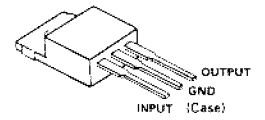

μPD78C10G-36

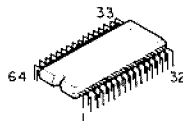

TC4011BF

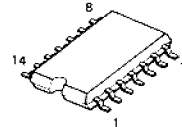

CXD1095Q

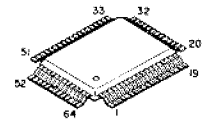

TC5564APL-15

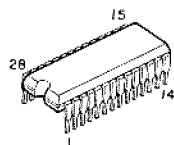

TC74HC138AF

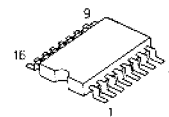

MB89363B

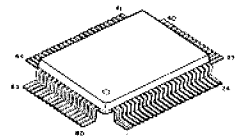

TC4052BF

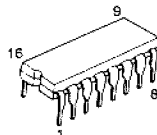

CAT35C102KI

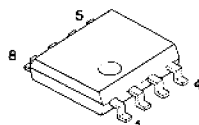

MB3780A

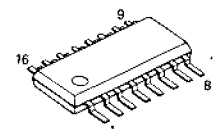

DIGITAL UNIT (X46-308X-XX)

0-11 : K,K2,P,P2 0-21 : M,M2 0-22 : M3,M4 0-71 : X,X2 2-71 : E,E2 2-72 : E3,E4

DIGITAL UNIT (X46-308X-XX)(A/4)(2/2)

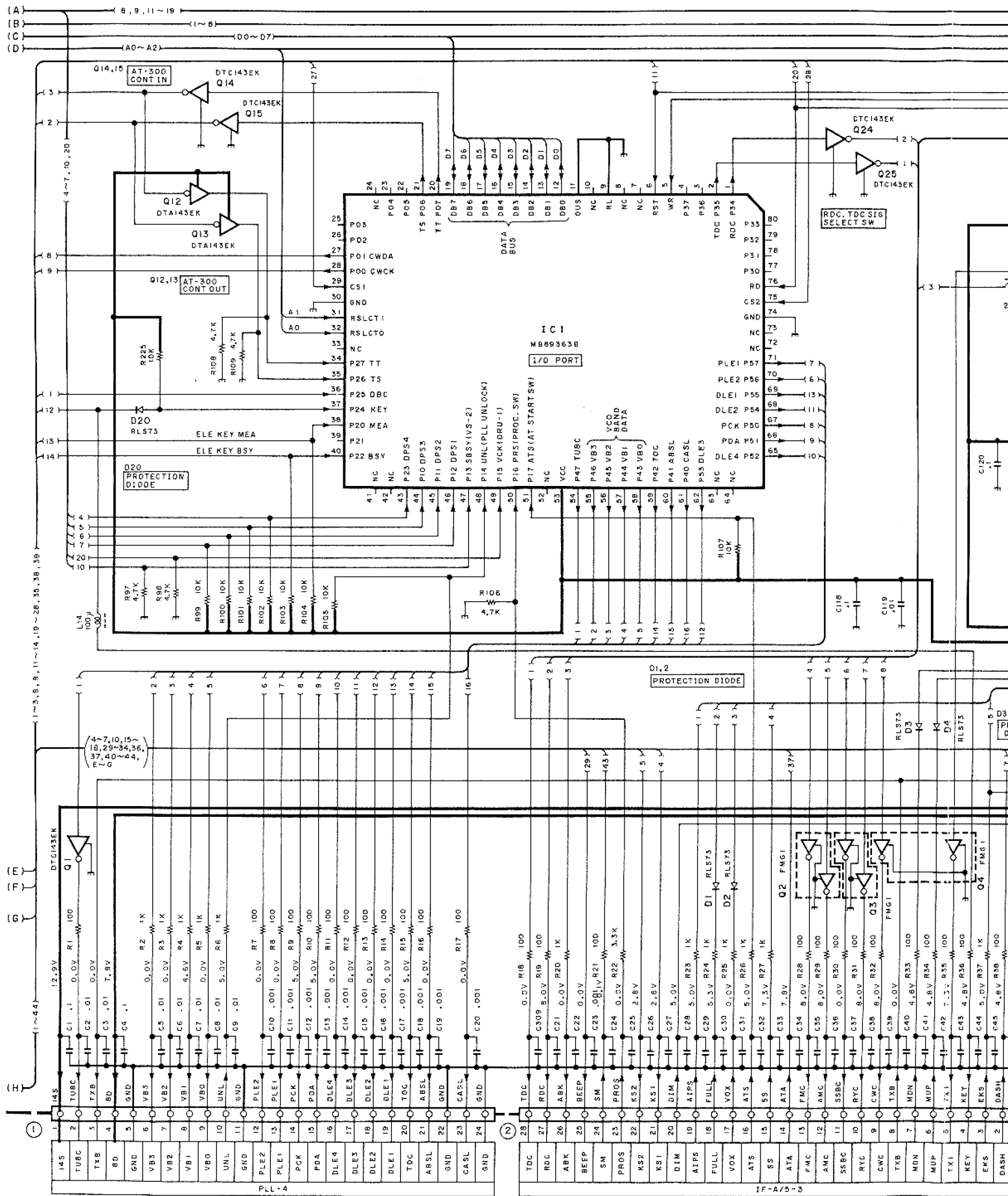

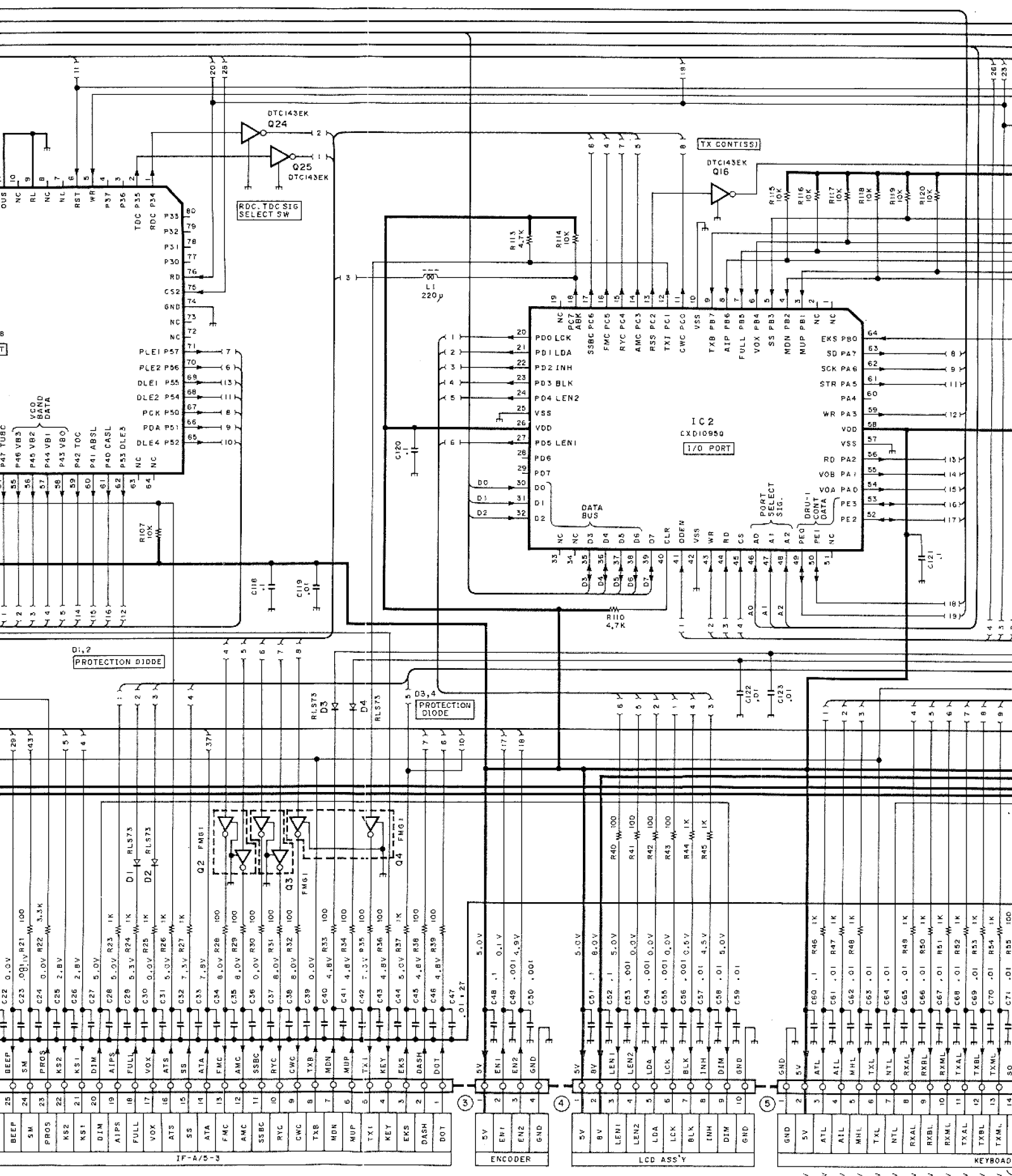

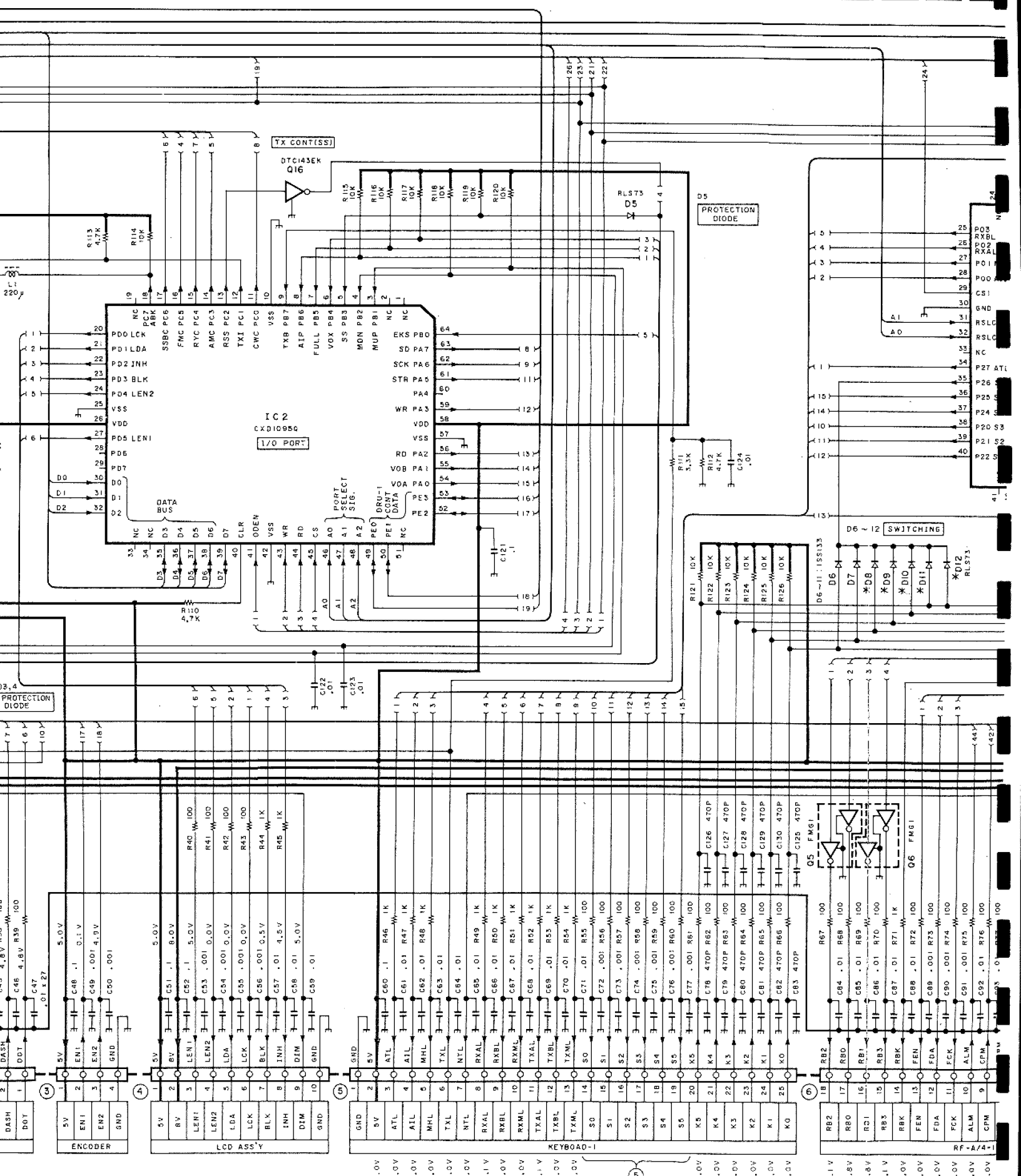

CIRCUIT DIAGRAM TS-850S

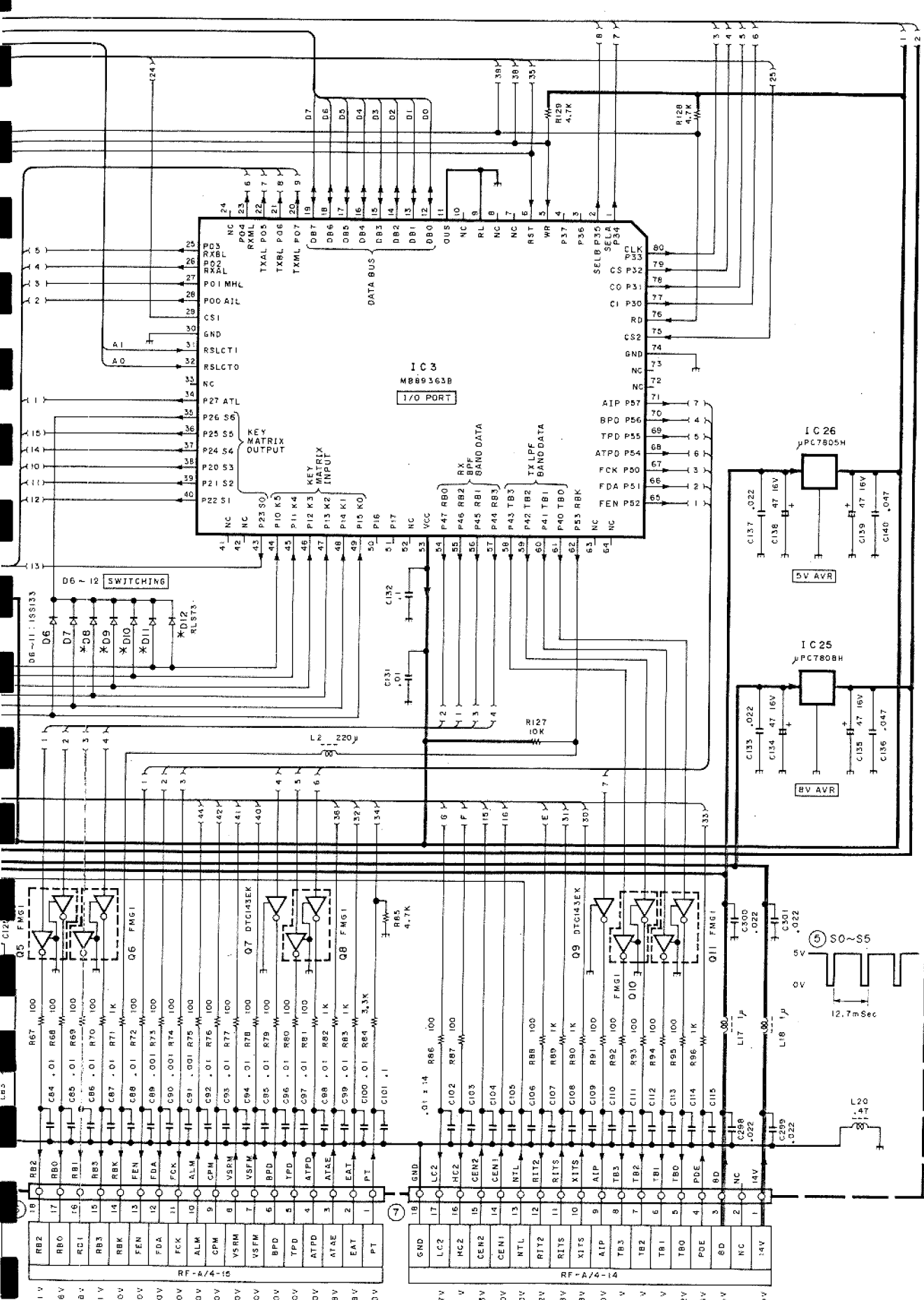

0-00	0-01	0-21	0-22	0-71	2-71	2-72
J1S,D,V1	K,K2,P,P2	M,M2	M3,M4	X,X2	E,E2	E3,E4
D8	X	X	X	X	X	X
D9	X	X	X	X	X	X
D10	X	X	X	X	X	X
D11	X	X	X	X	X	X
D12	X	X	X	X	X	X

TS-850S PC BOARD VIEWS

TA7302P

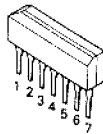

NJM2904M
NJM4558M

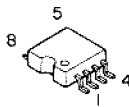

2SA1162(Y)
2SC2712(Y)
2SC3324(G)
2SD1757K
DTA124EK
DTC114EK
DTC124EK
DTC114TK



TA7324P

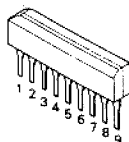

μ PC2002V

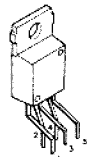

2SK210(GR)



μ PC1037HA

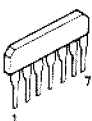

TC4011BF
TC4001BF
TC4066BF
TC4069UBF

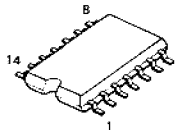

3SK131(M)

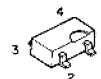

AN612

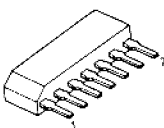

MC3357P

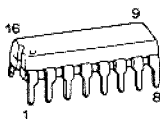

FMA1
FMC2
FMG2

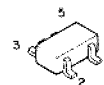

TC453813BF

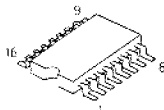

2SA1213(Y)



IF UNIT (X48-3080-00) Component side view

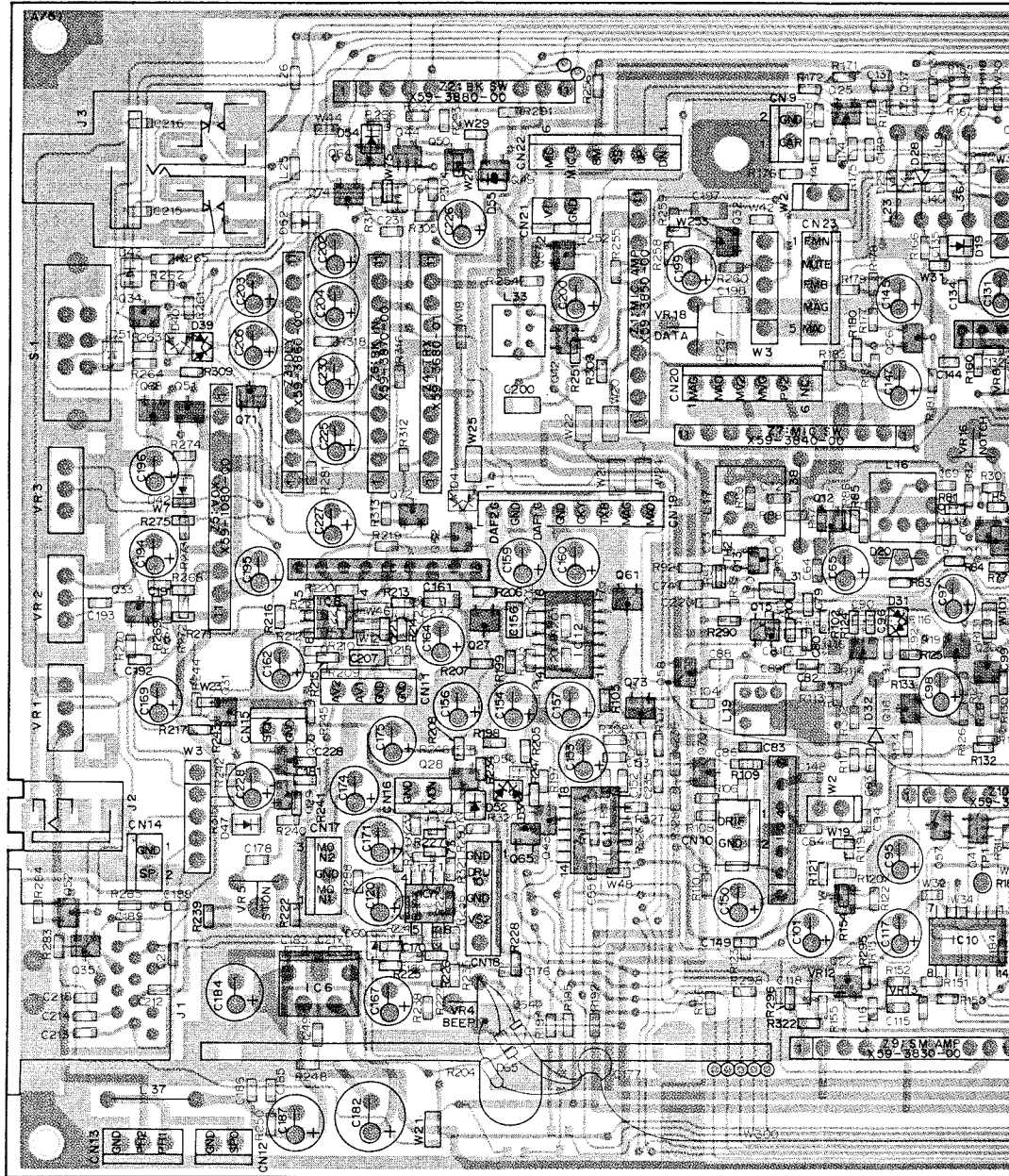
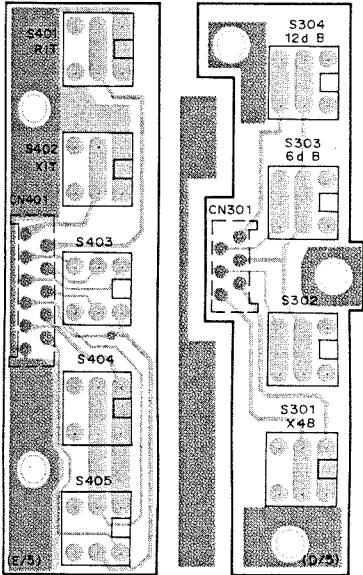
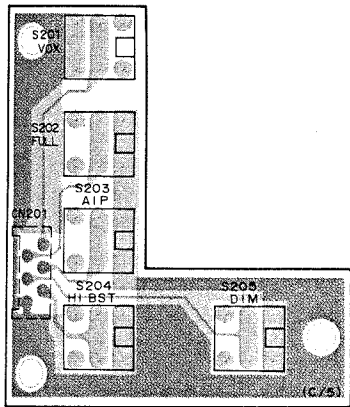
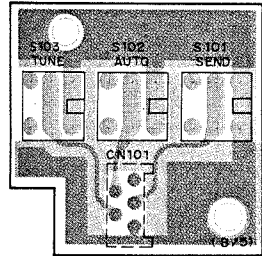

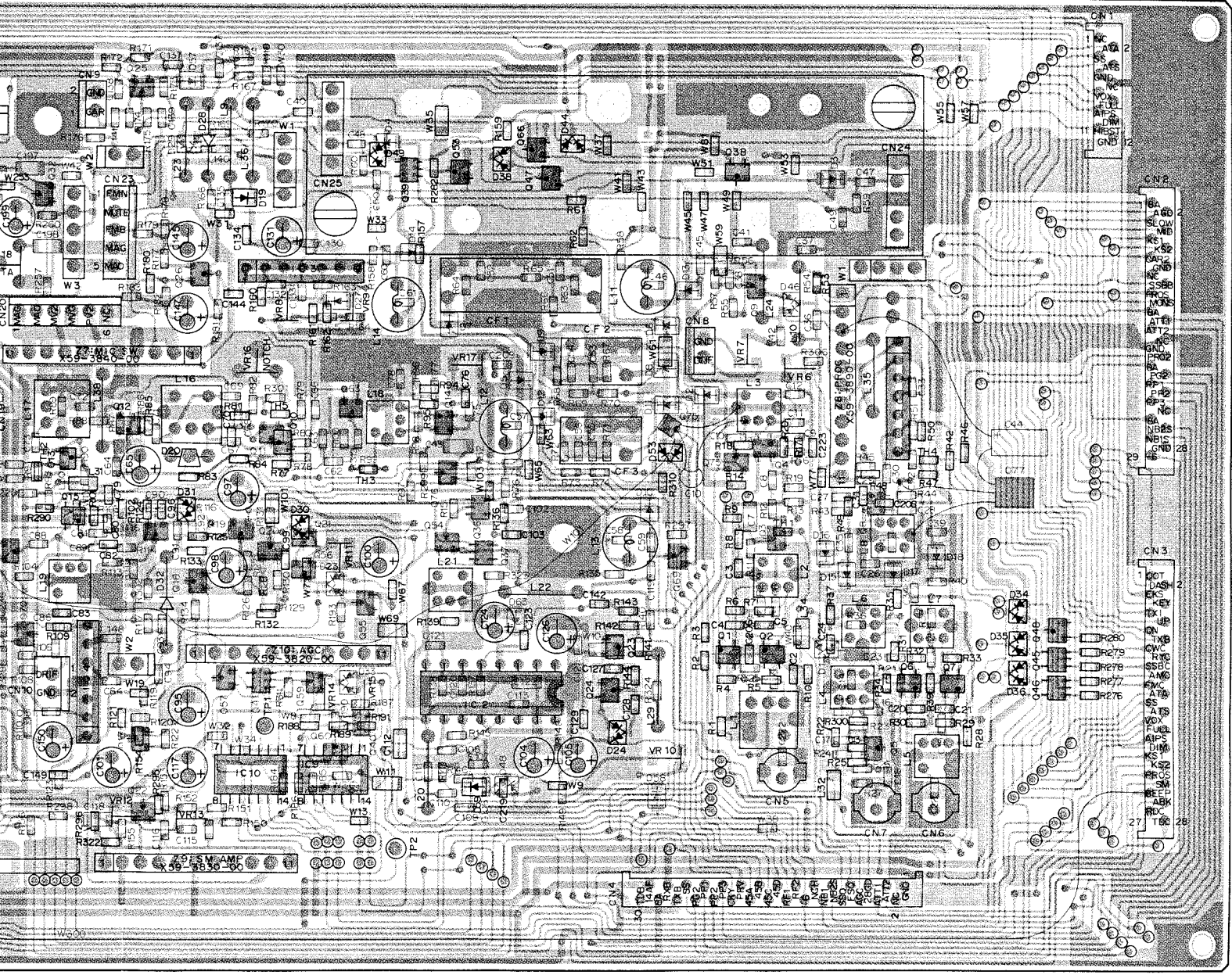

IF UNIT (X48-3080-00) Foil side view

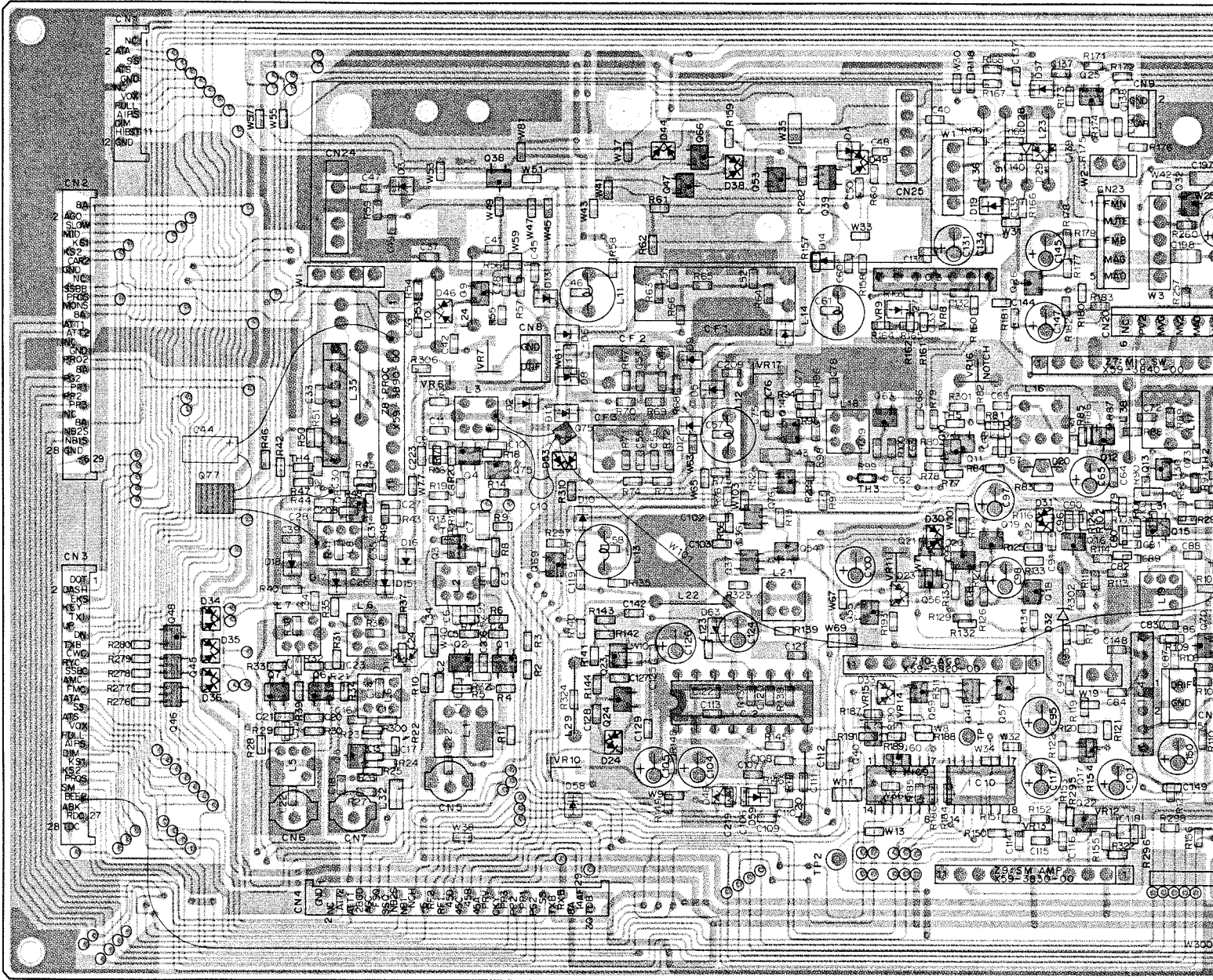

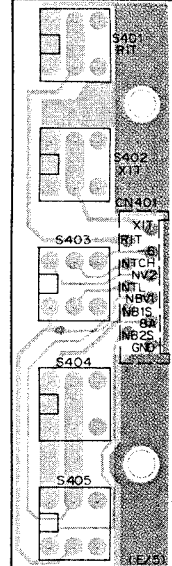
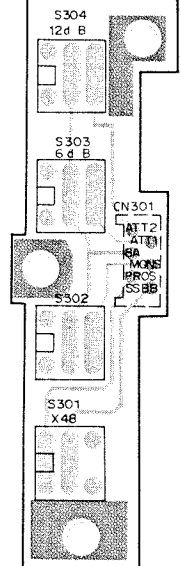
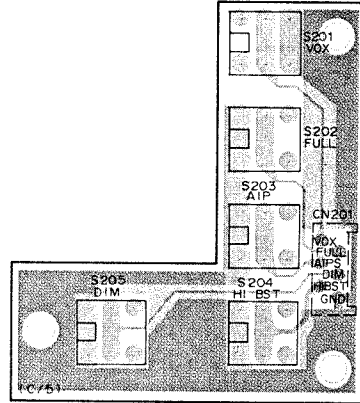
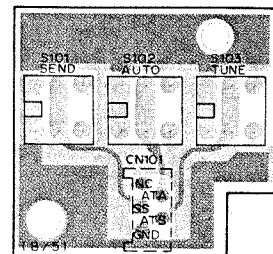
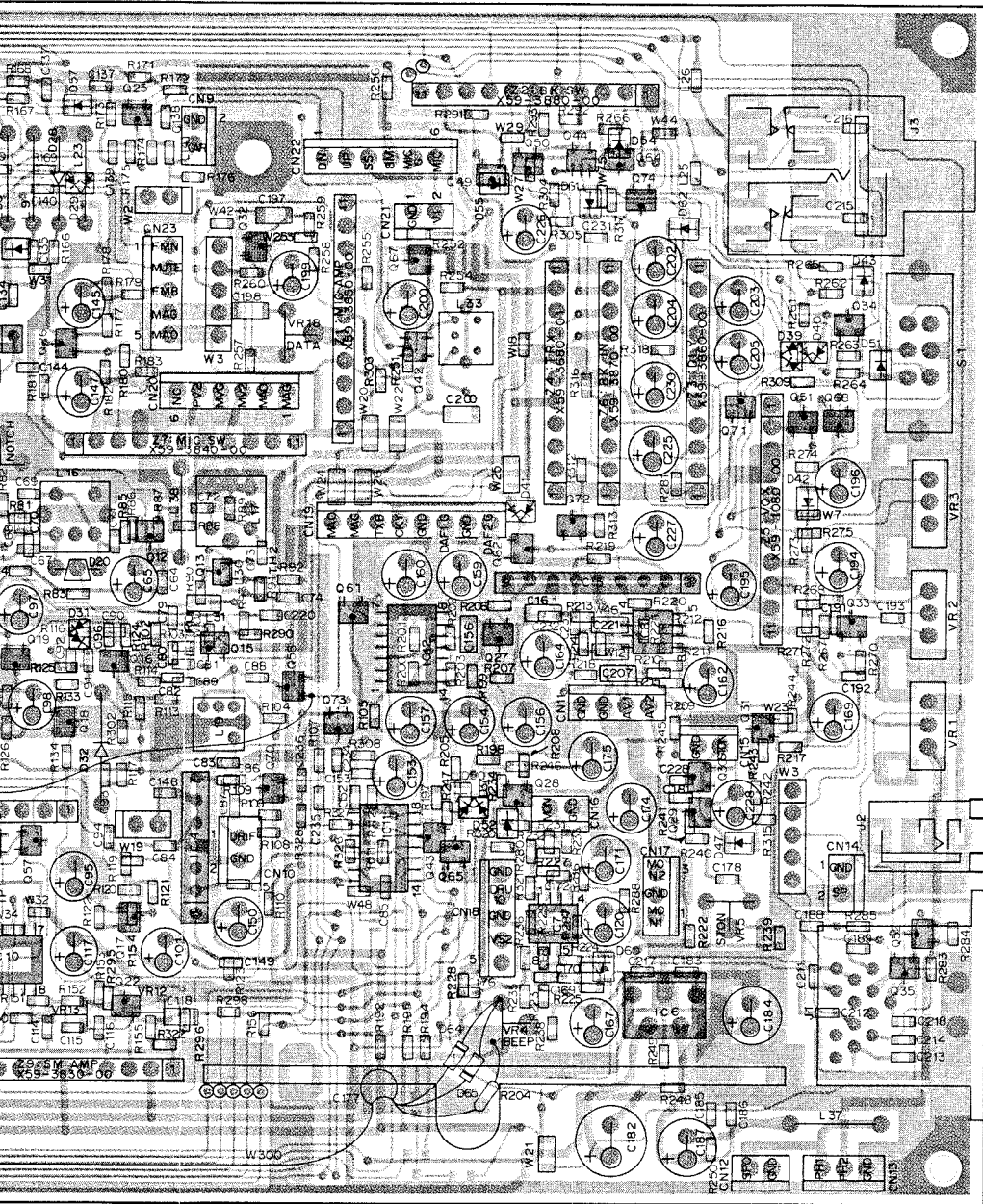

VOX (X59-1080-00) Component side view

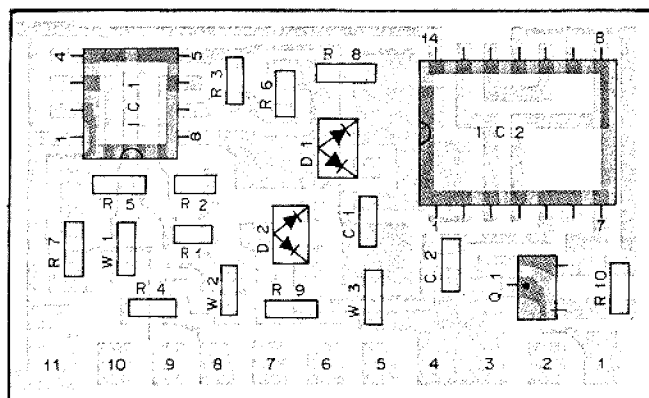

TRX (X59-3680-01) Component side view

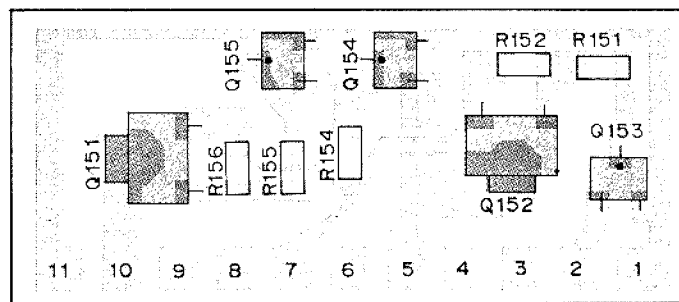

AGC (X59-3820-00) Component side view

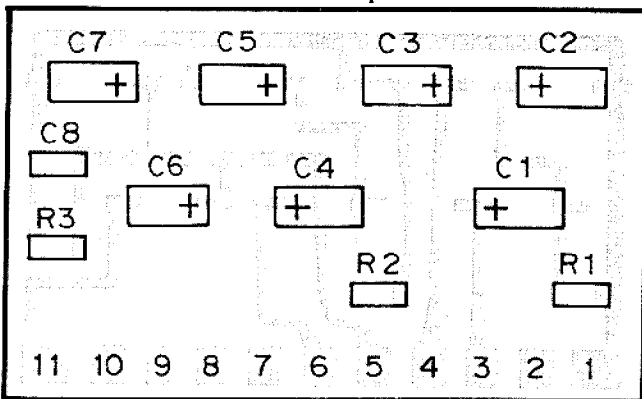

SM AMP (X59-3830-00) Component side view

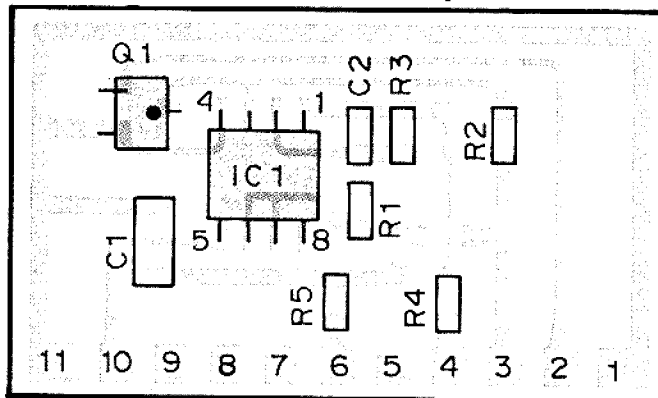

MIC SW (X59-3840-00) Component side view

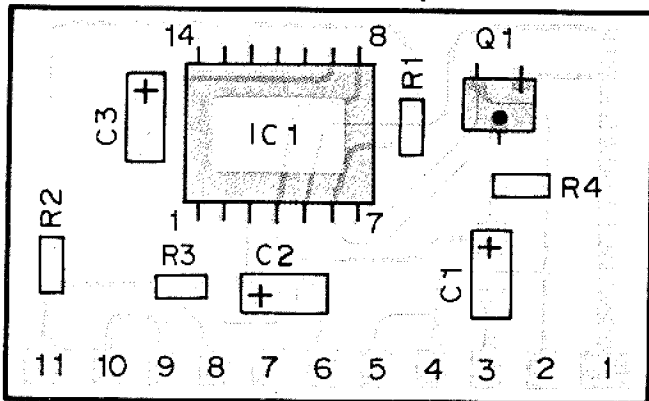

MIC AMP (X59-3850-00) Component side view

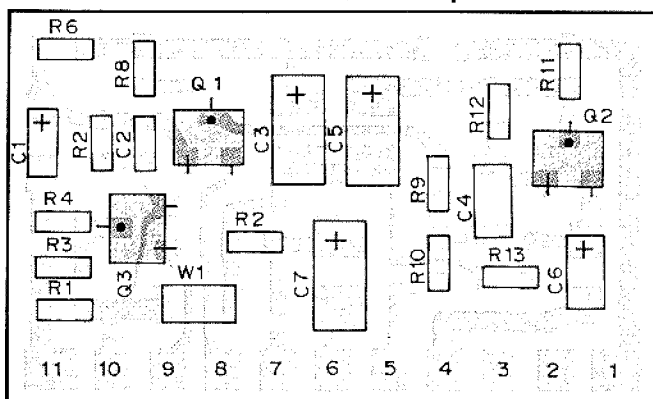

PC BOARD VIEWS TS-850S

DELAY (X59-3860-00) Component side view

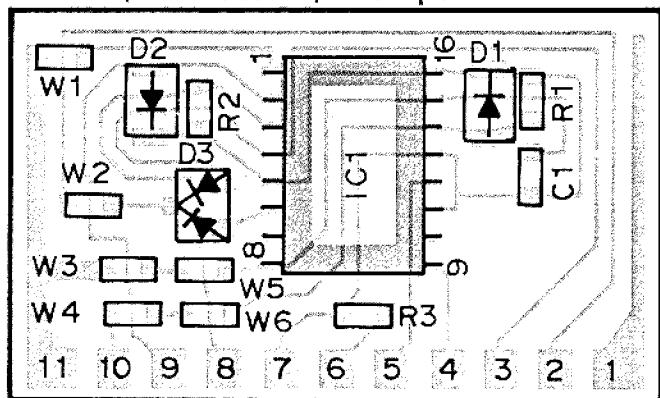

BK IN (X59-3870-00) Component side view

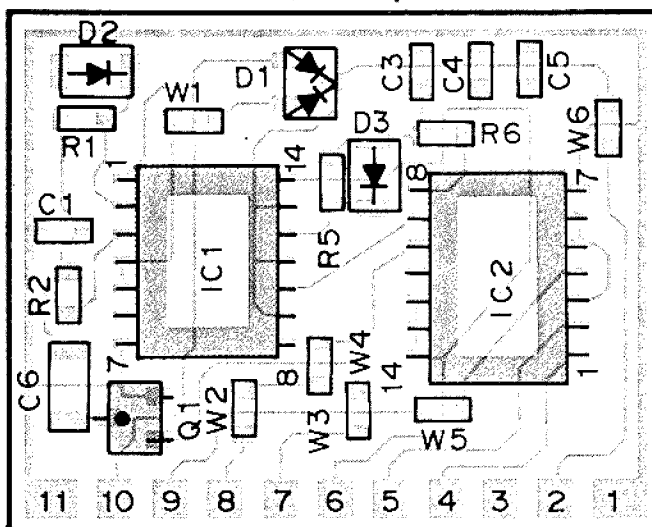

BK SW (X59-3880-00) Component side view

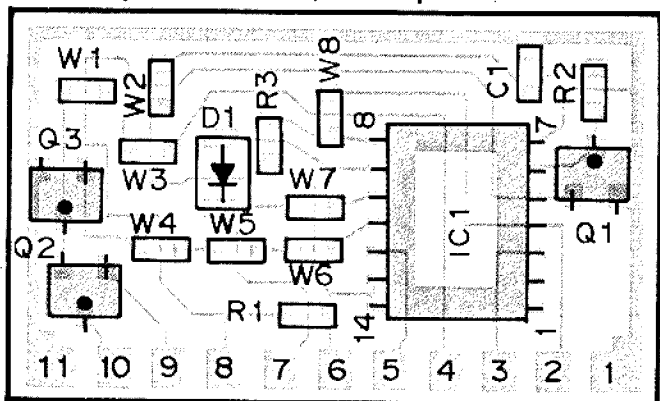

PROC AMP (X59-3890-00) Component side view

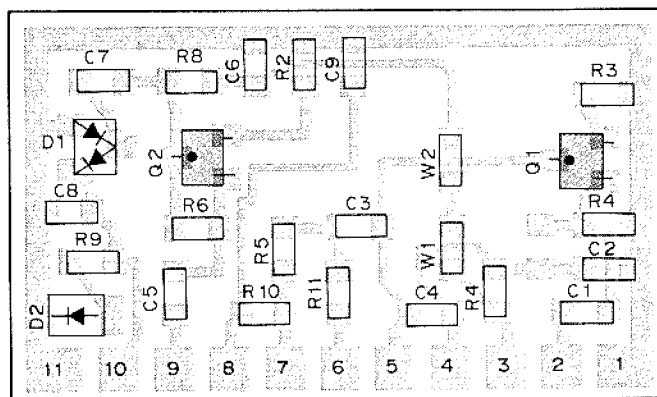

TS-850S CIRCUIT DIAGRAM

IF UNIT (X48-3080-00)

IF UNIT (X48-3080-00) (A/5) (1/2)

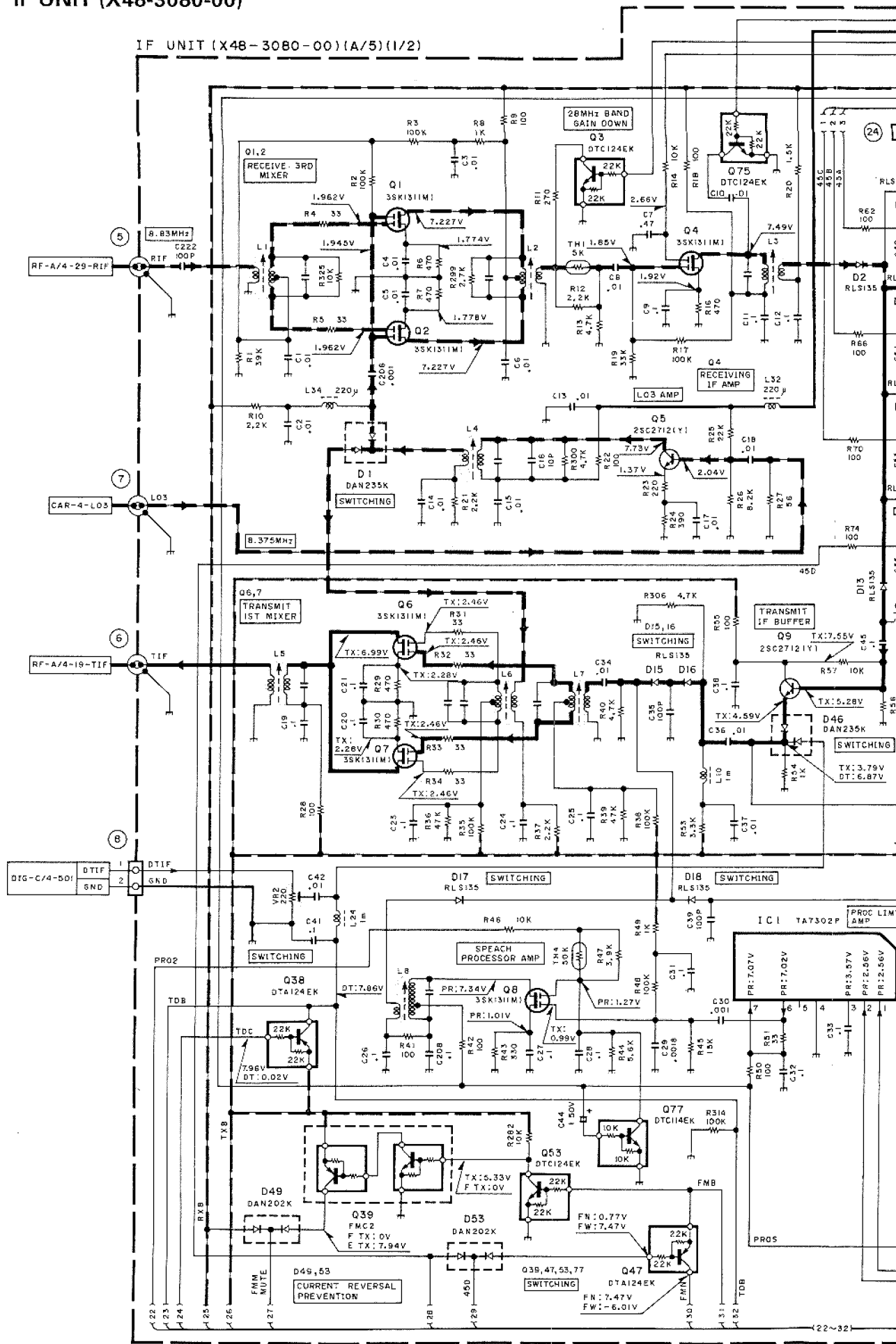

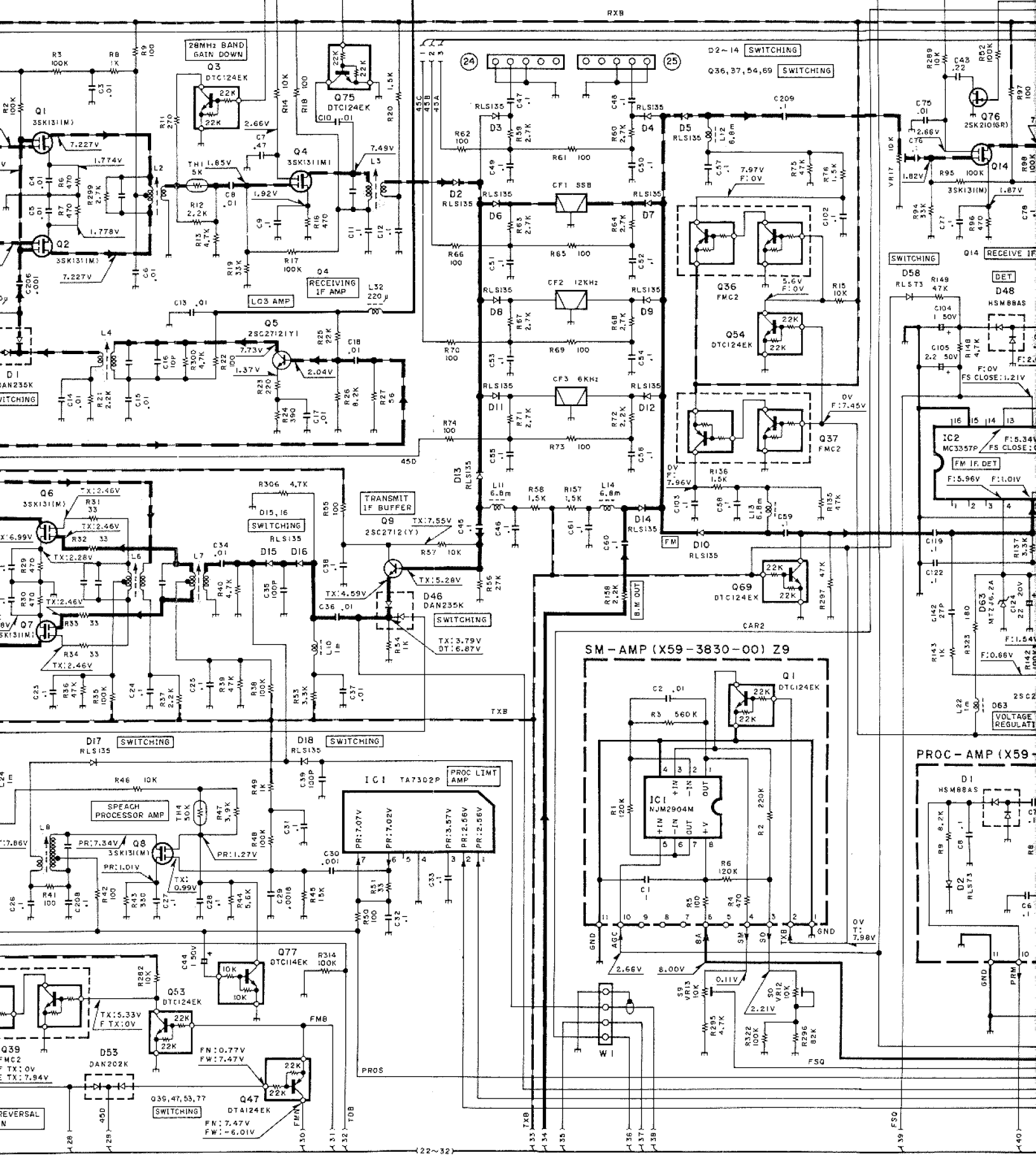

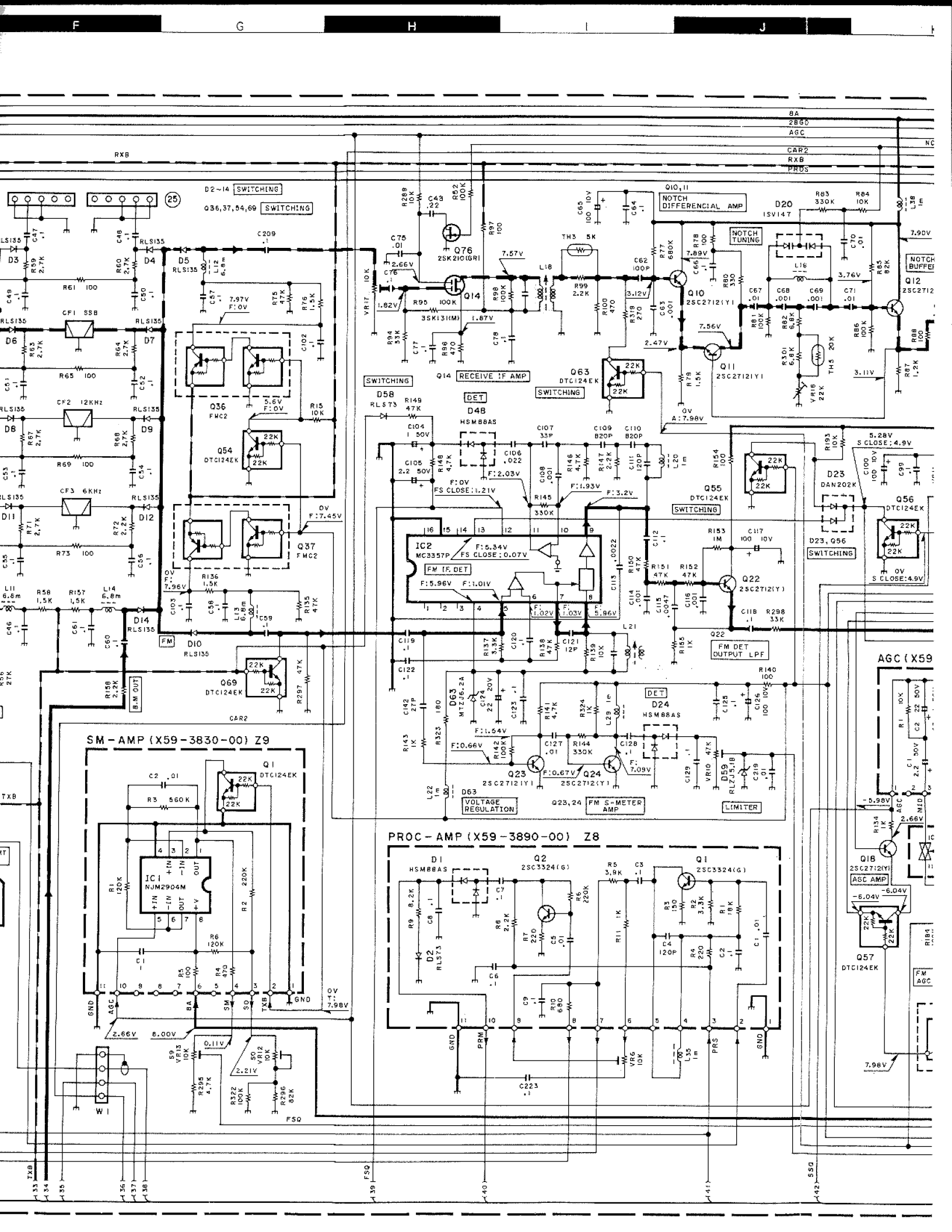

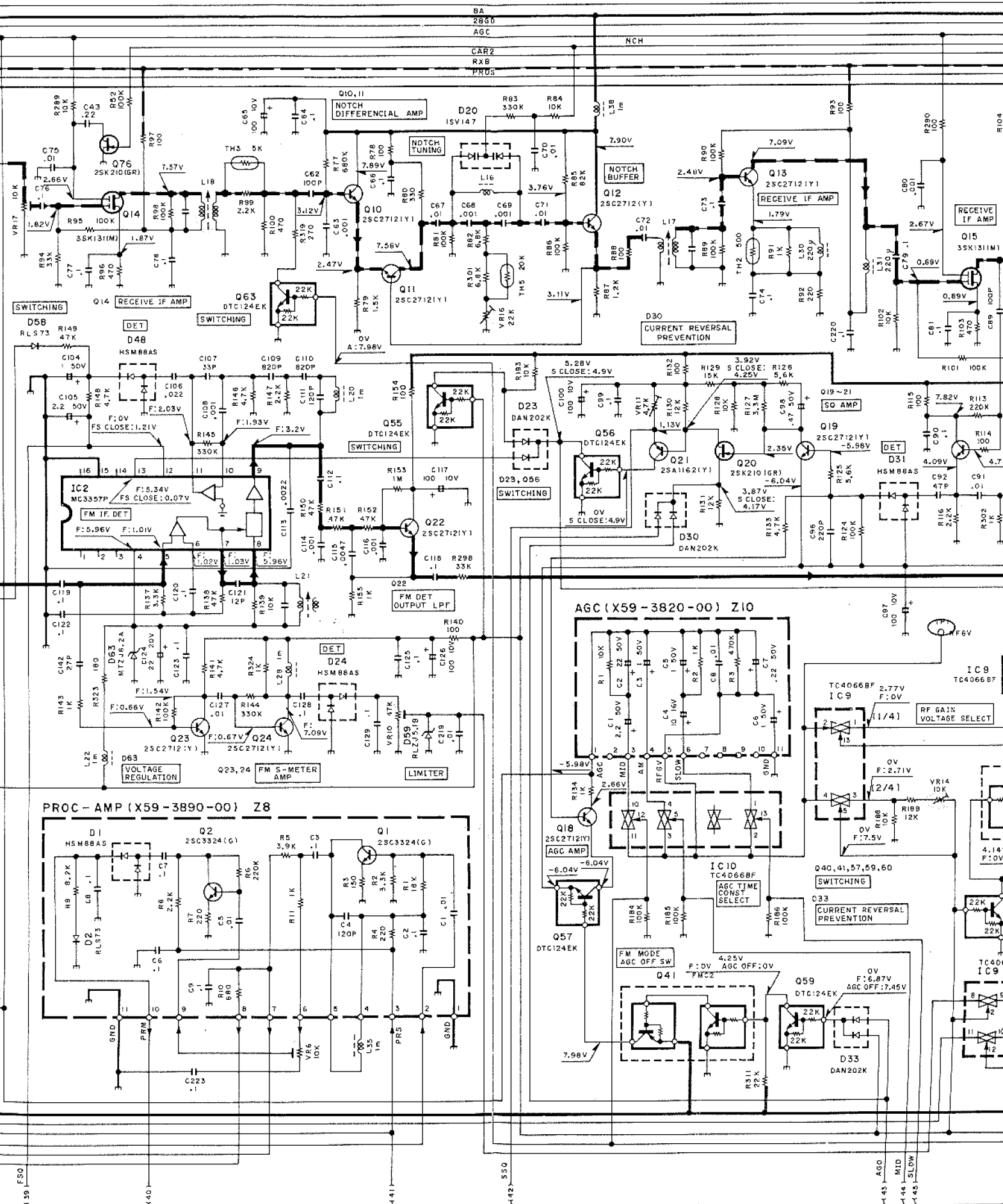

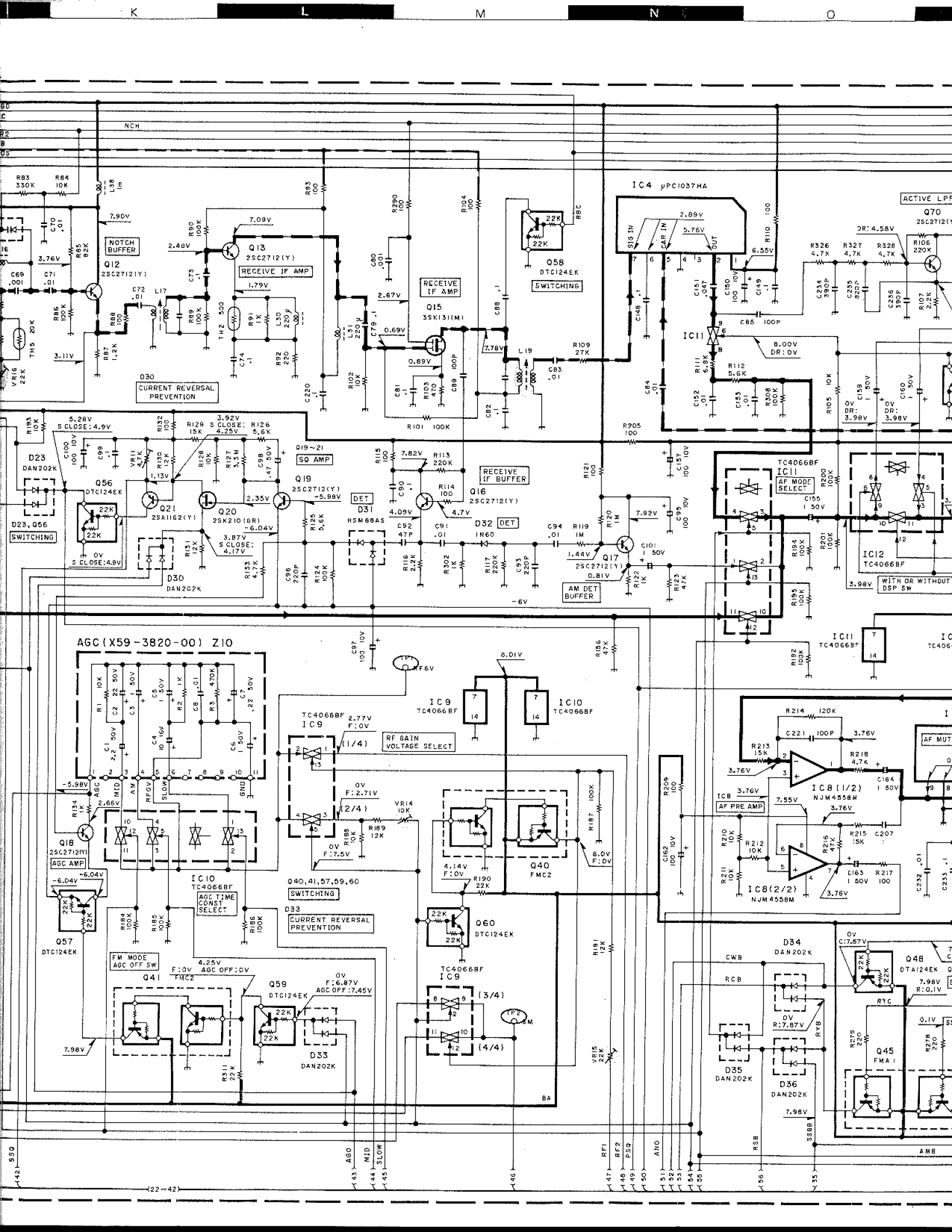

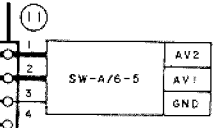
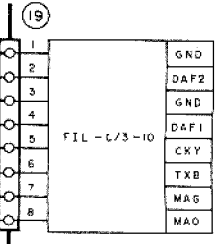
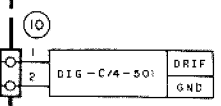
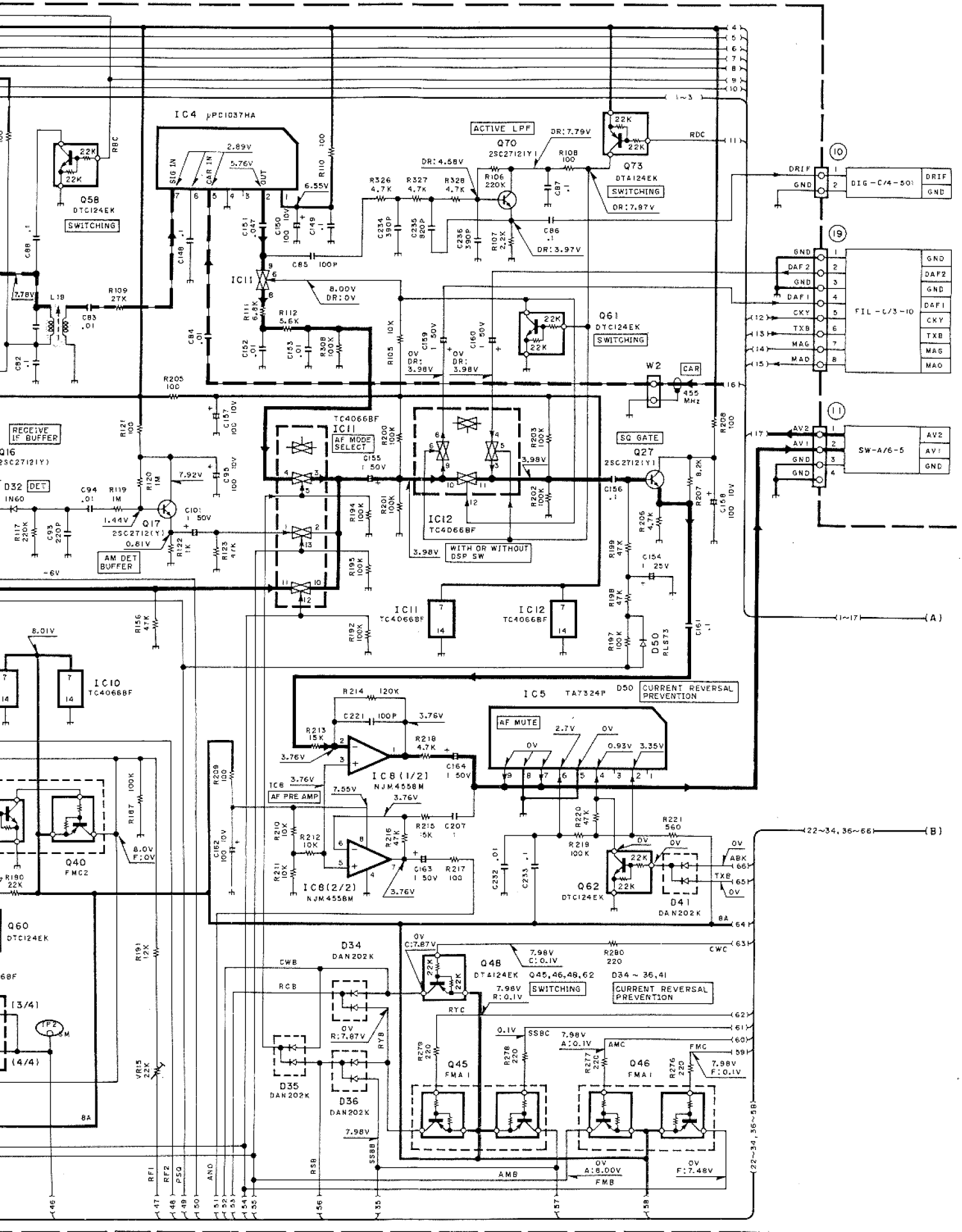

(A)

(B)

22-34, 36-58

22-34, 36-58

IF UNIT (X48-3080-00)

IF UNIT (X48-3080-00) (A/5) (2/2)

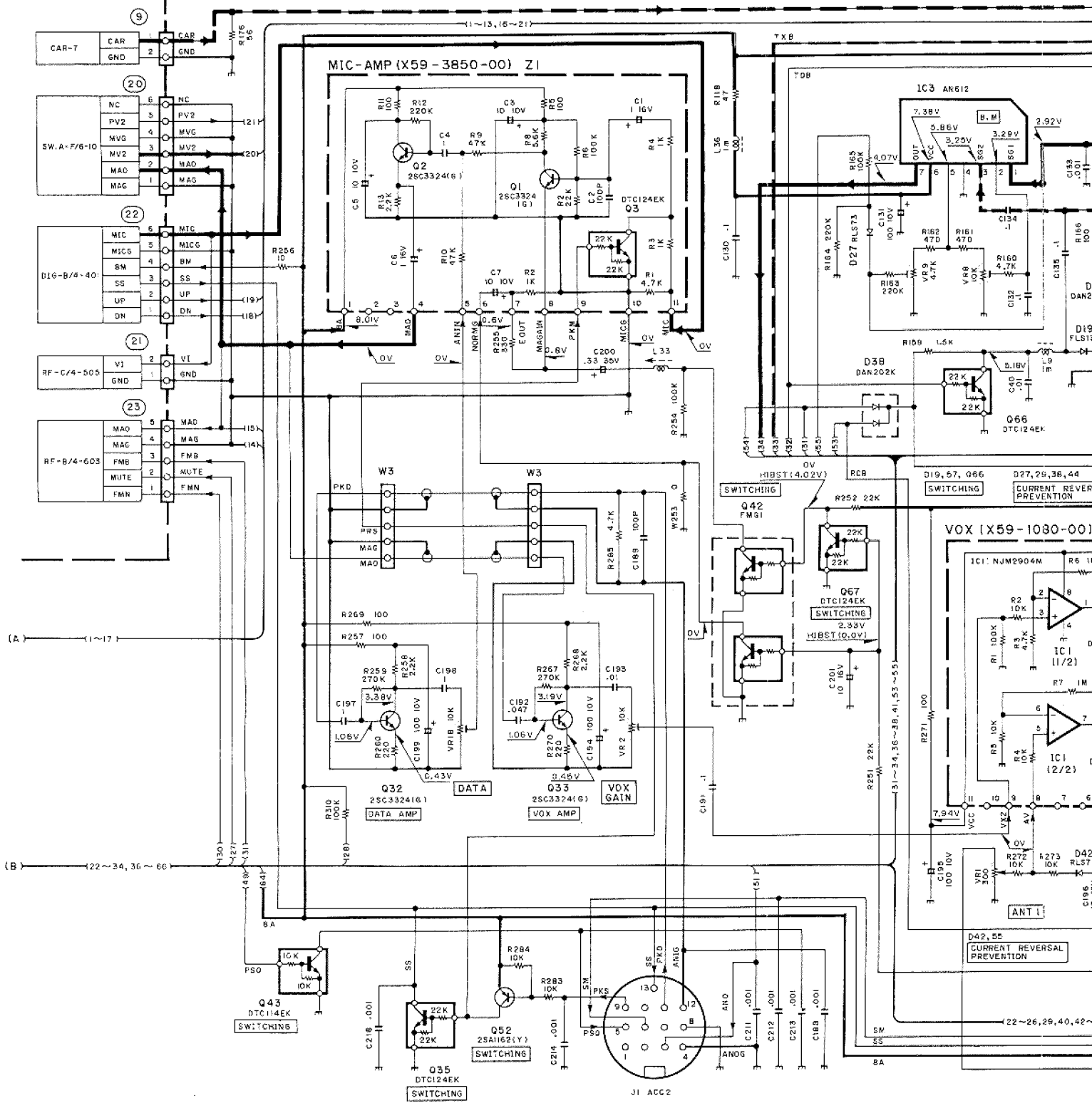

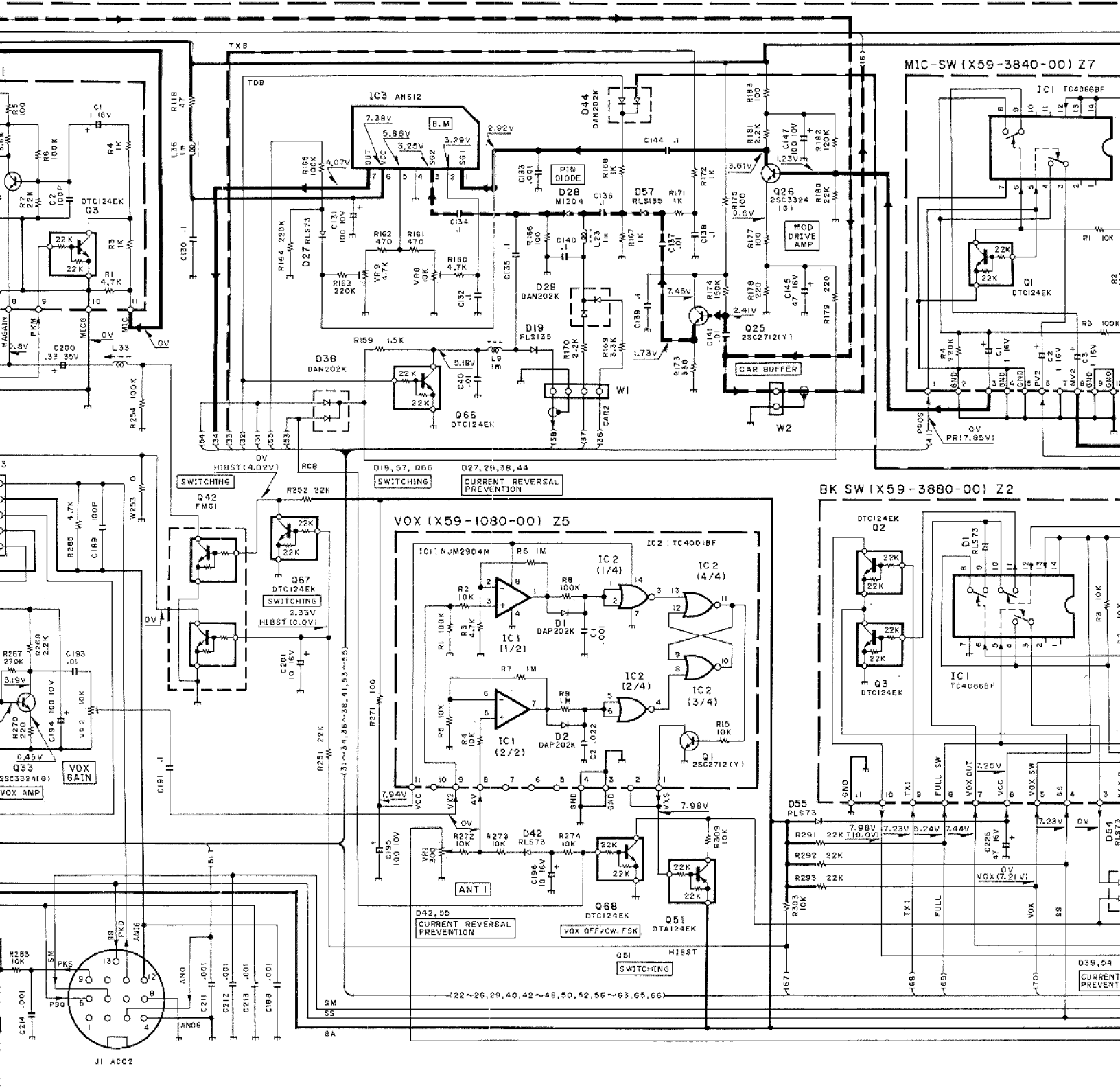

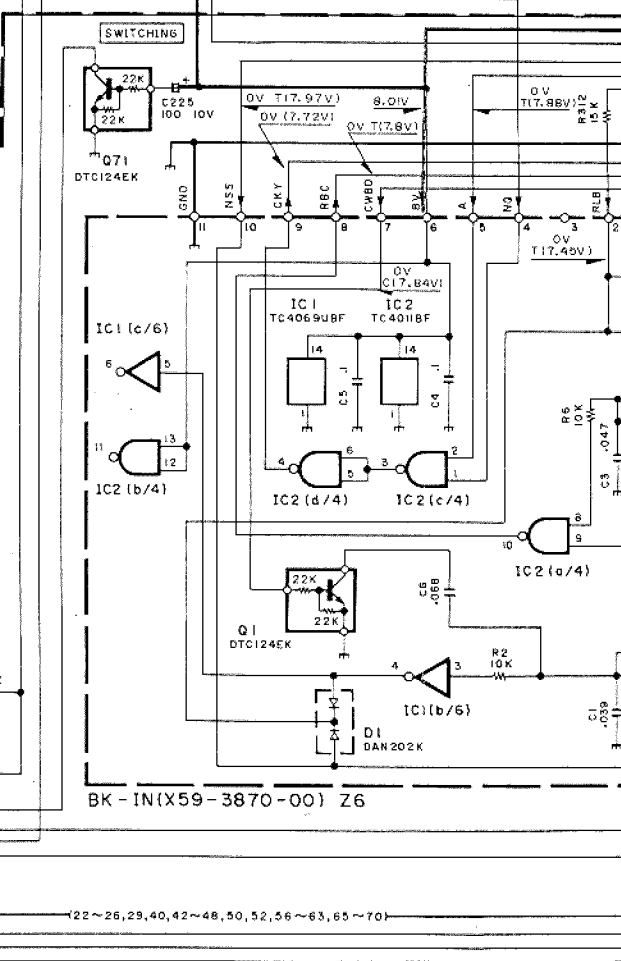
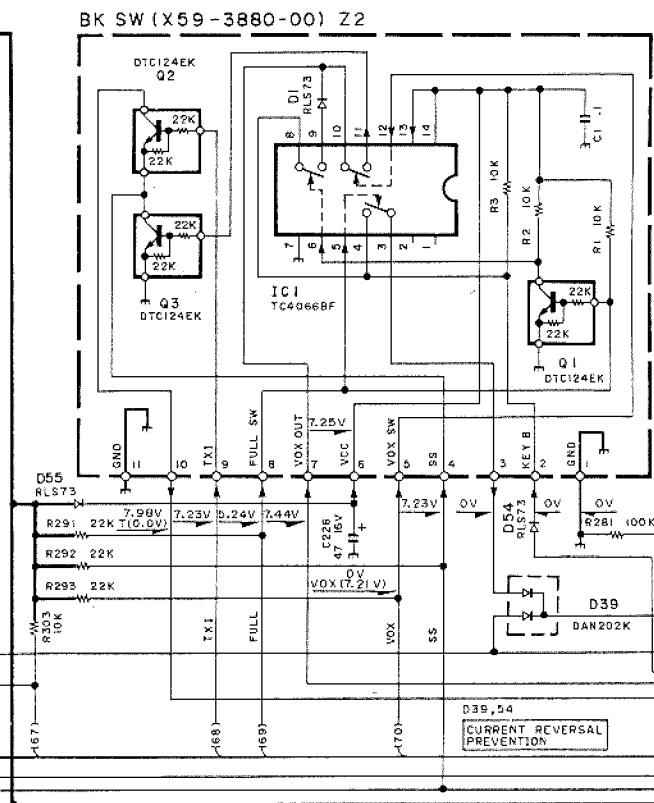
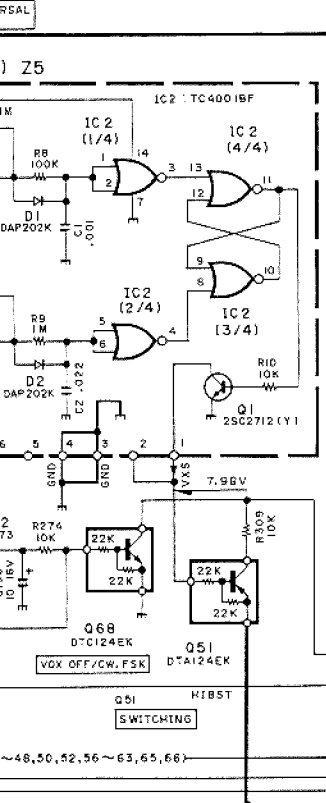
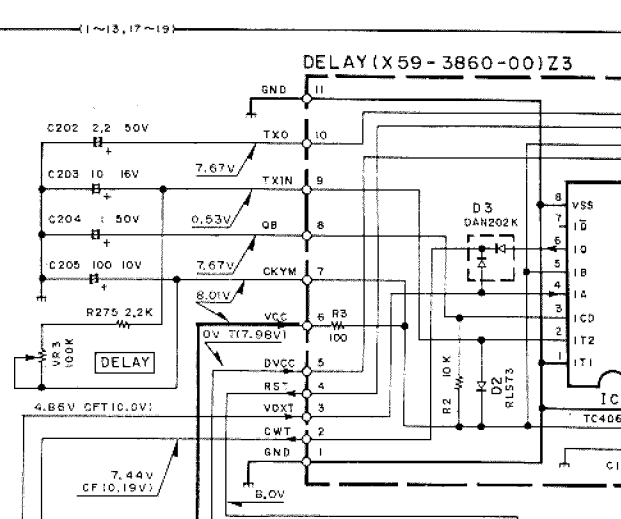
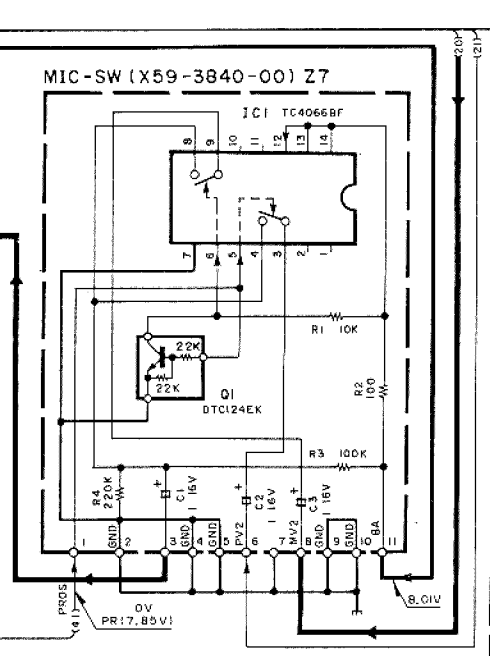
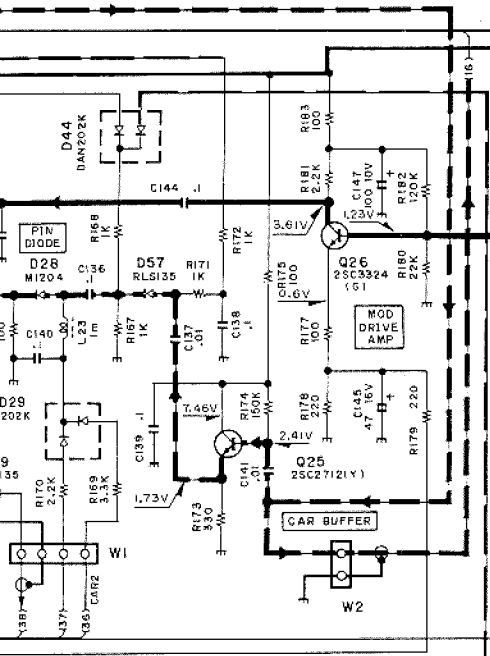

~48,50,52,56~63,65,66

(22~26,29,40,42~48,50,52,56~63,65~70)

DELAY (X59-3860-00) Z3

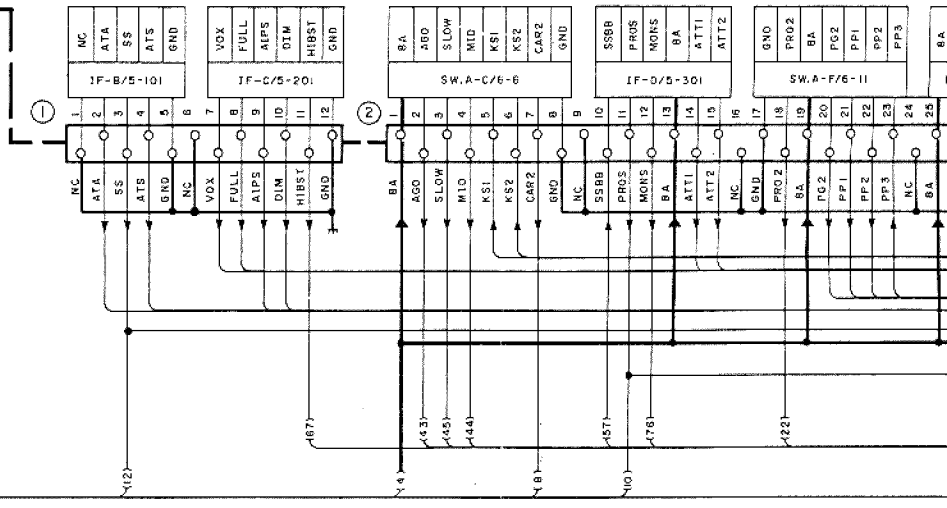
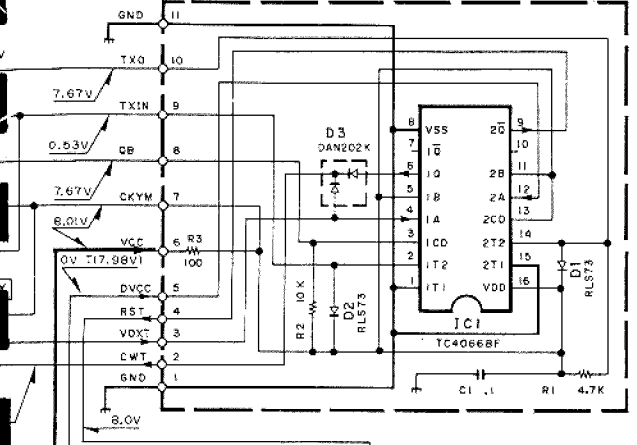

TRX (X59-3860-01) Z4

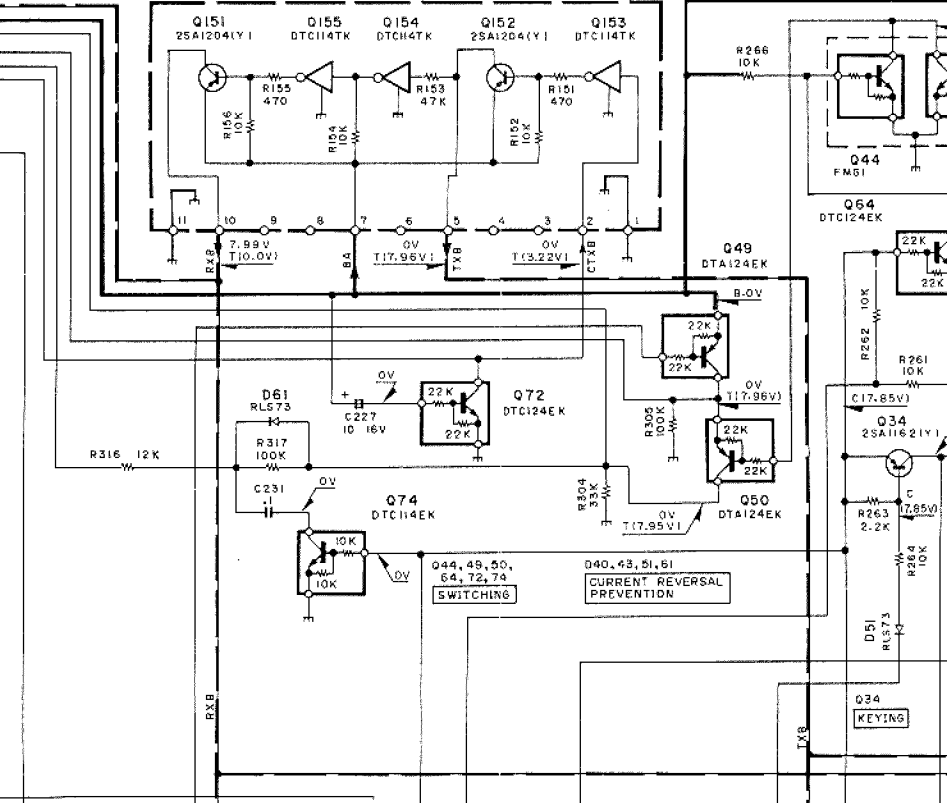

IN (X59-3870-00) Z6

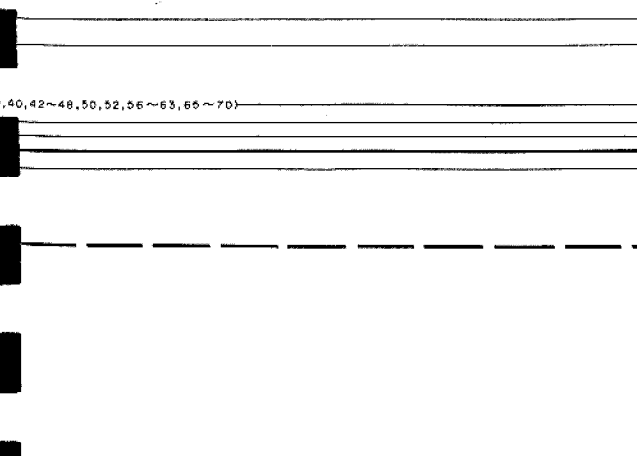

CURRENT REVERSAL PREVENTION

S1 ELECTRIC KEY

J3 KEY

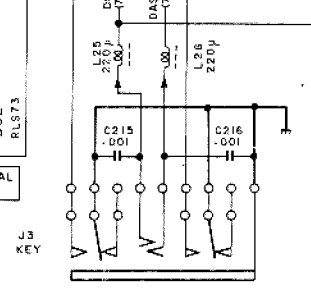
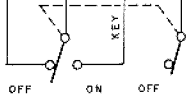

CIRCUIT DIAGRAM TS-850S

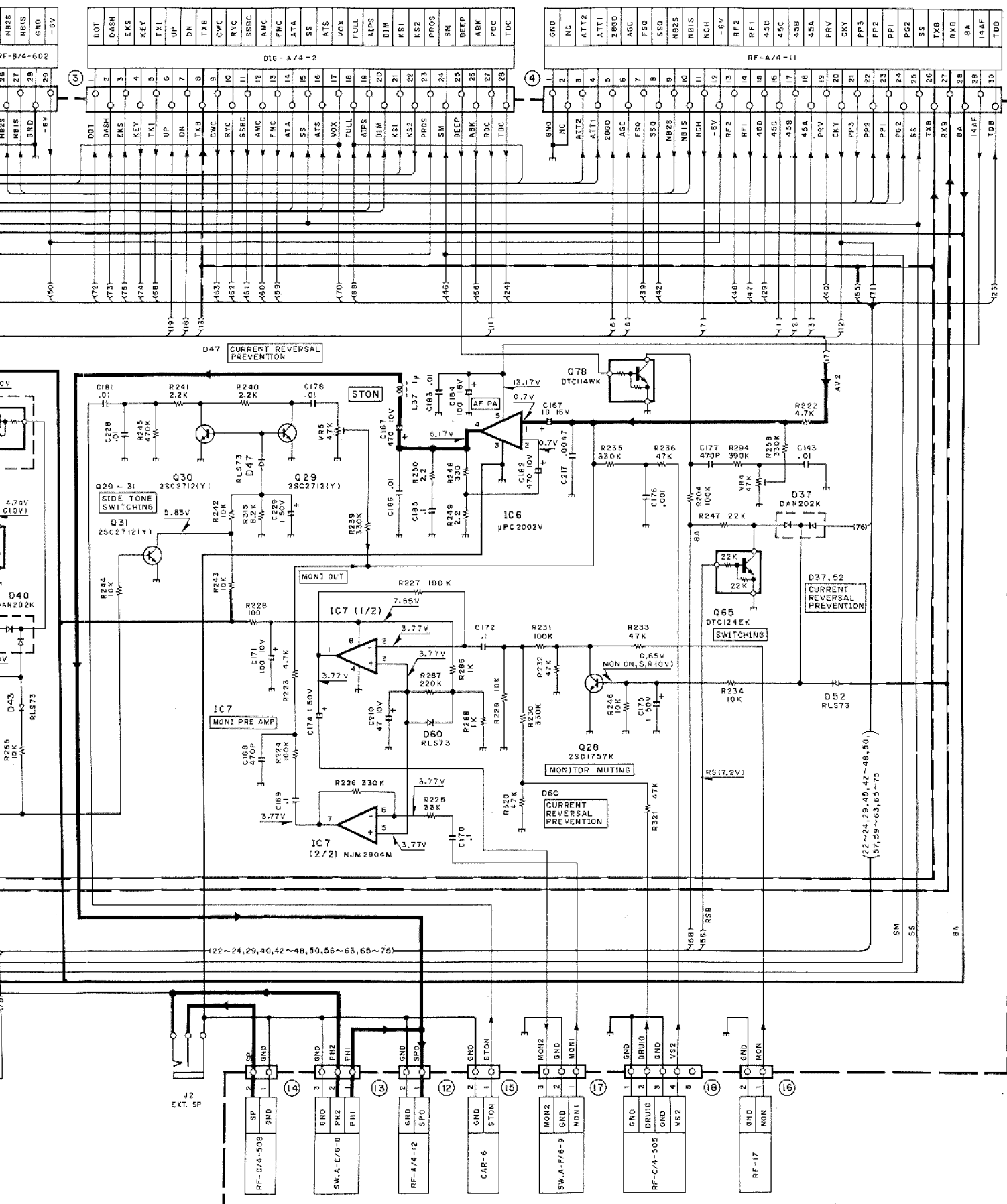

TS-850S PC BOARD VIEWS

PLL UNIT (X50-3130-00) Component side view

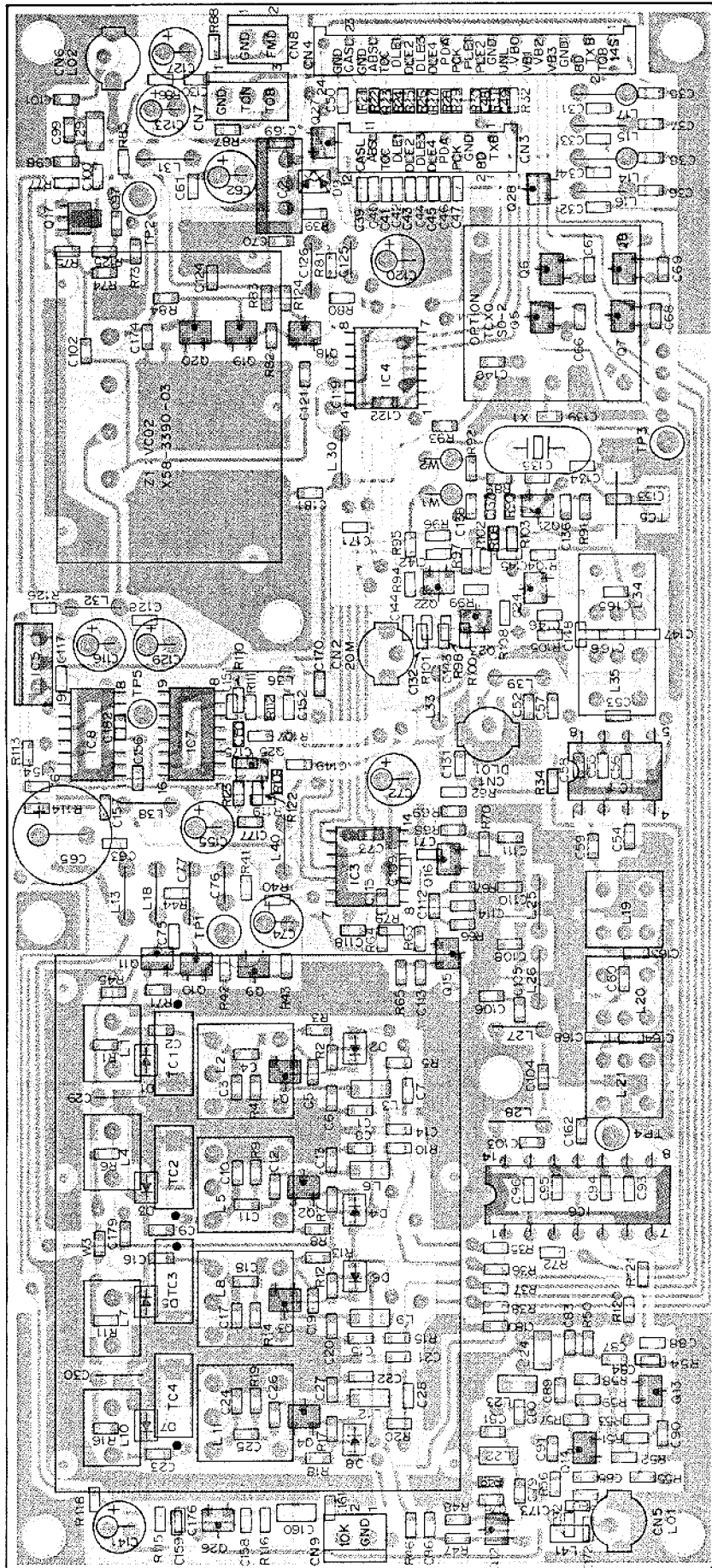

PLL UNIT (X50-3130-00) Foil side view

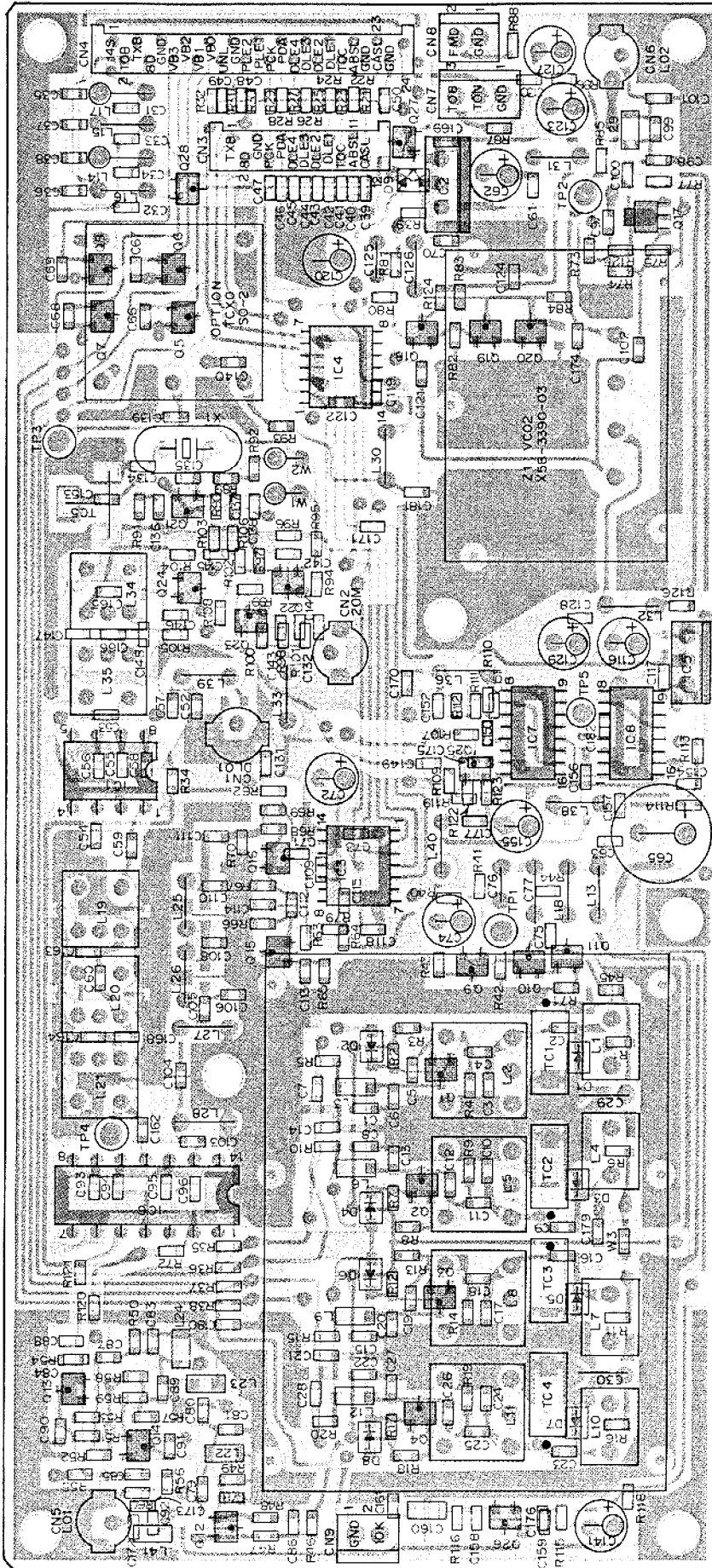

VCO2 (X58-3390-03) Component side view

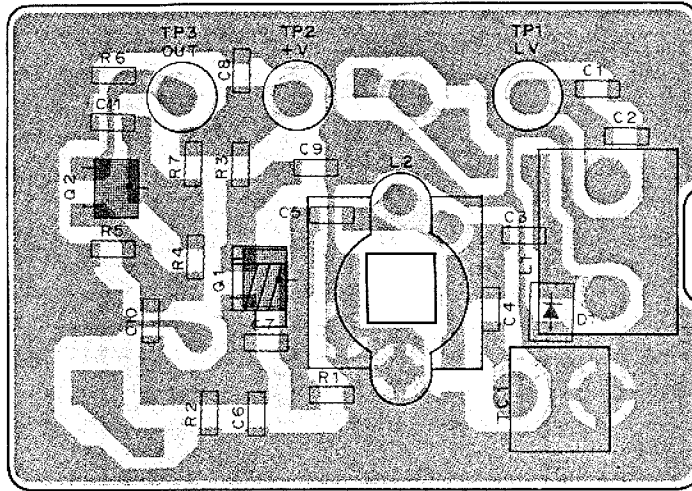

VCO2 (X58-3390-03) Foil side view

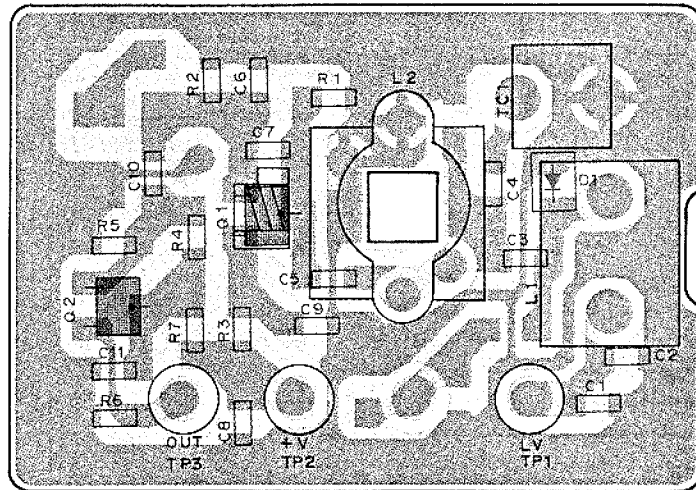

2SC2996(Y)
2SC2712(Y)
2SC2714(Y)
2SC3324(G)
DTA114EK
DTC114EK
DTC114TK

CXD1225M

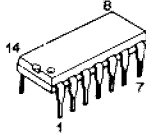

AN78N05

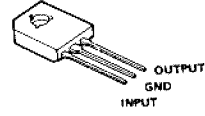

SN76514N

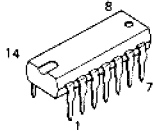

2SK210(GR)



2SC2954(QK)



SN16913P

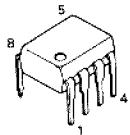

2SK508NV(K52)



TA78DL09P

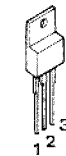

μPD74HC390G

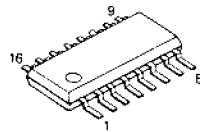

PLL UNIT (X50-3130-00)

④ PLL UNIT (X50-3130-00)

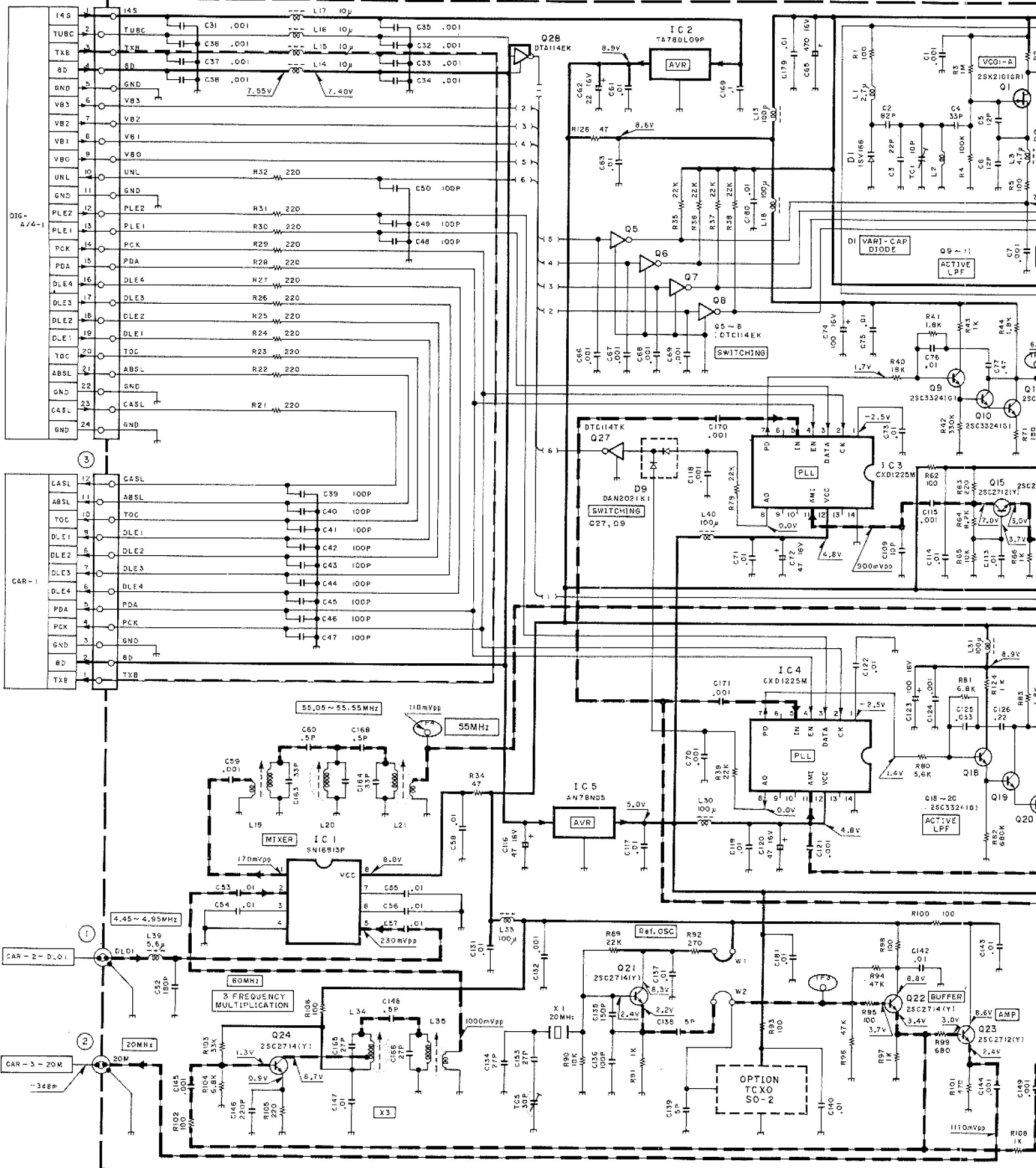

CIRCUIT DIAGRAM TS-850S

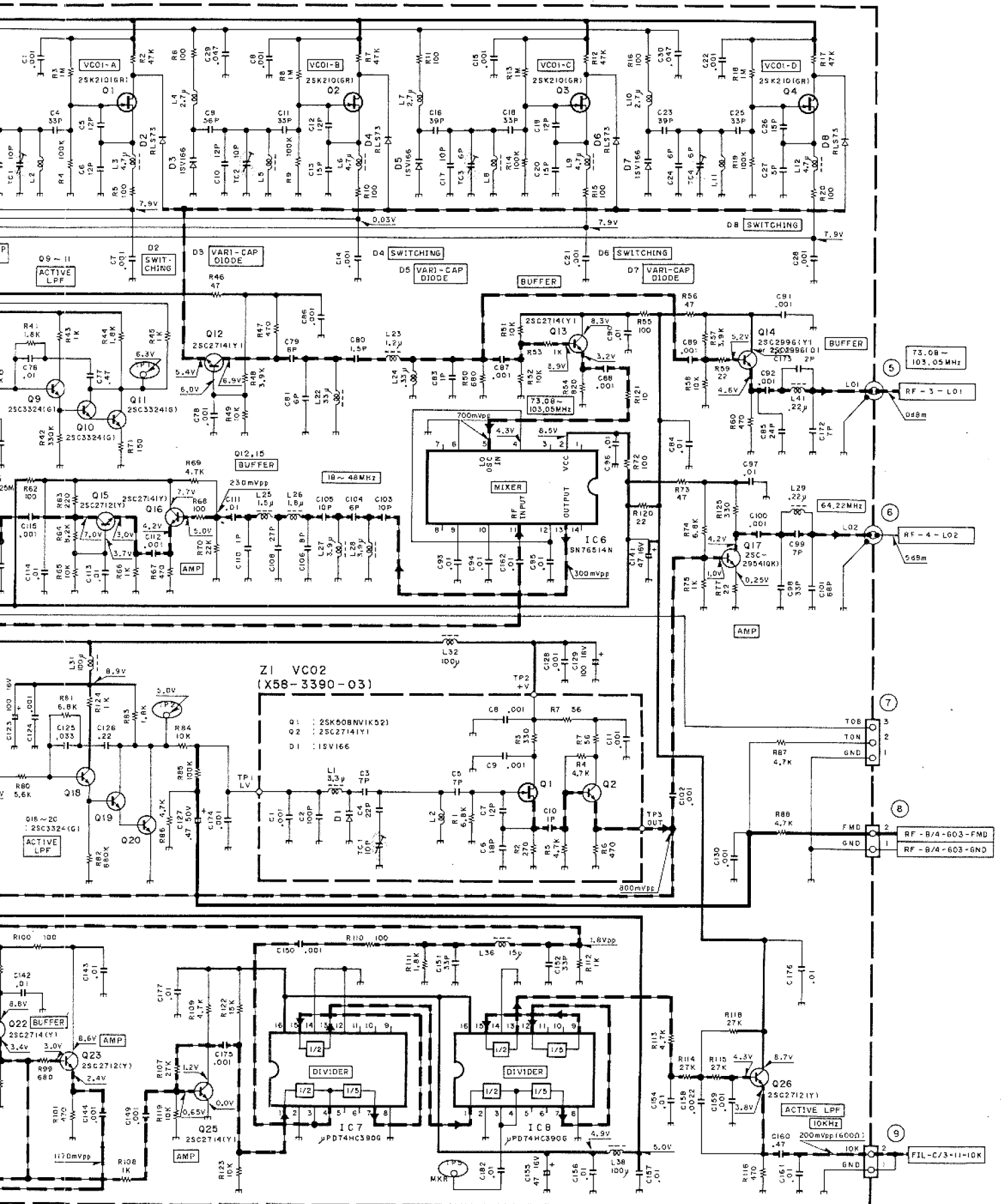

TS-850S PC BOARD VIEWS

CAR UNIT (X50-3140-00) Component side view

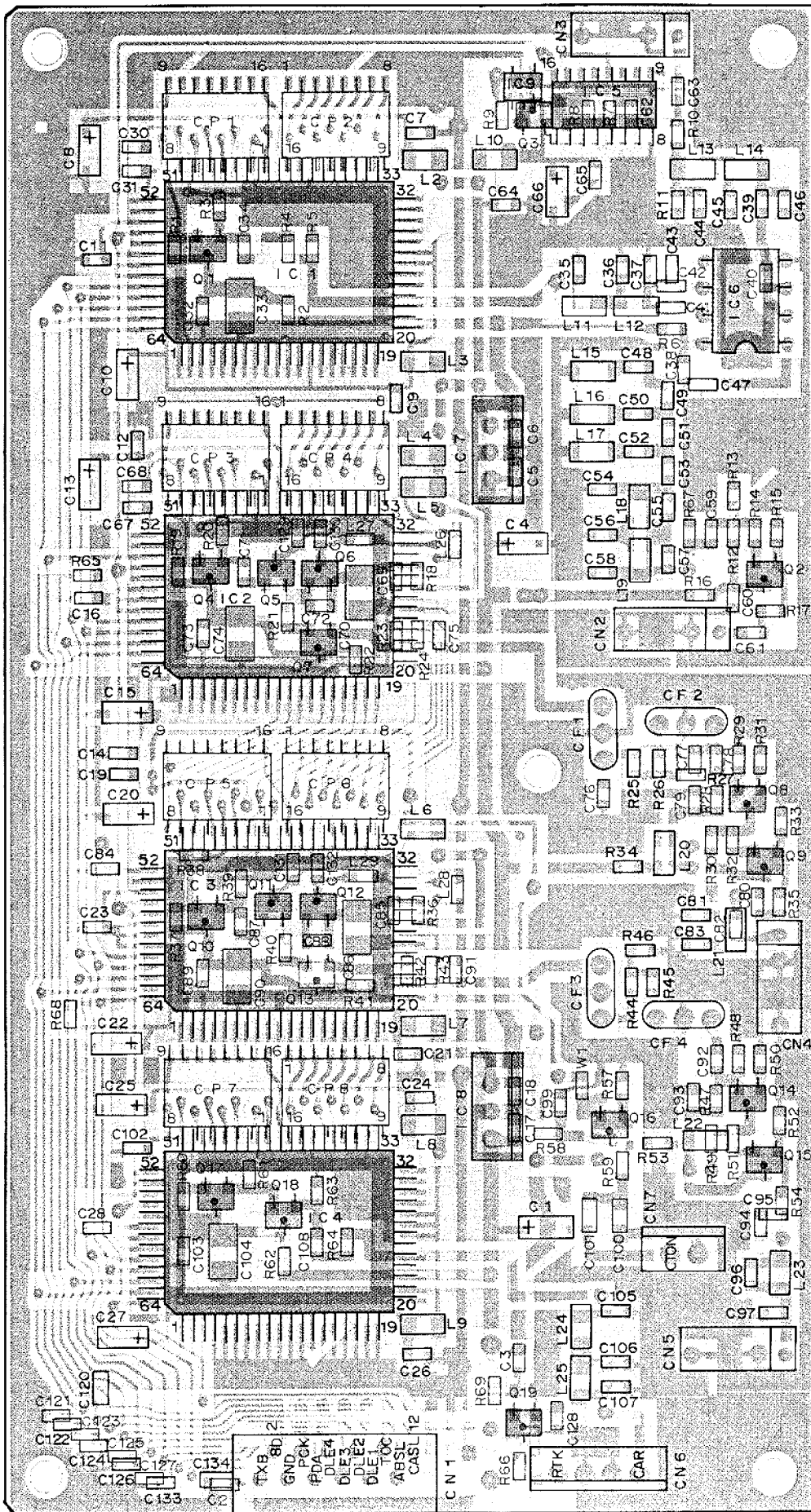

CAR UNIT (X50-3140-00) Foil side view

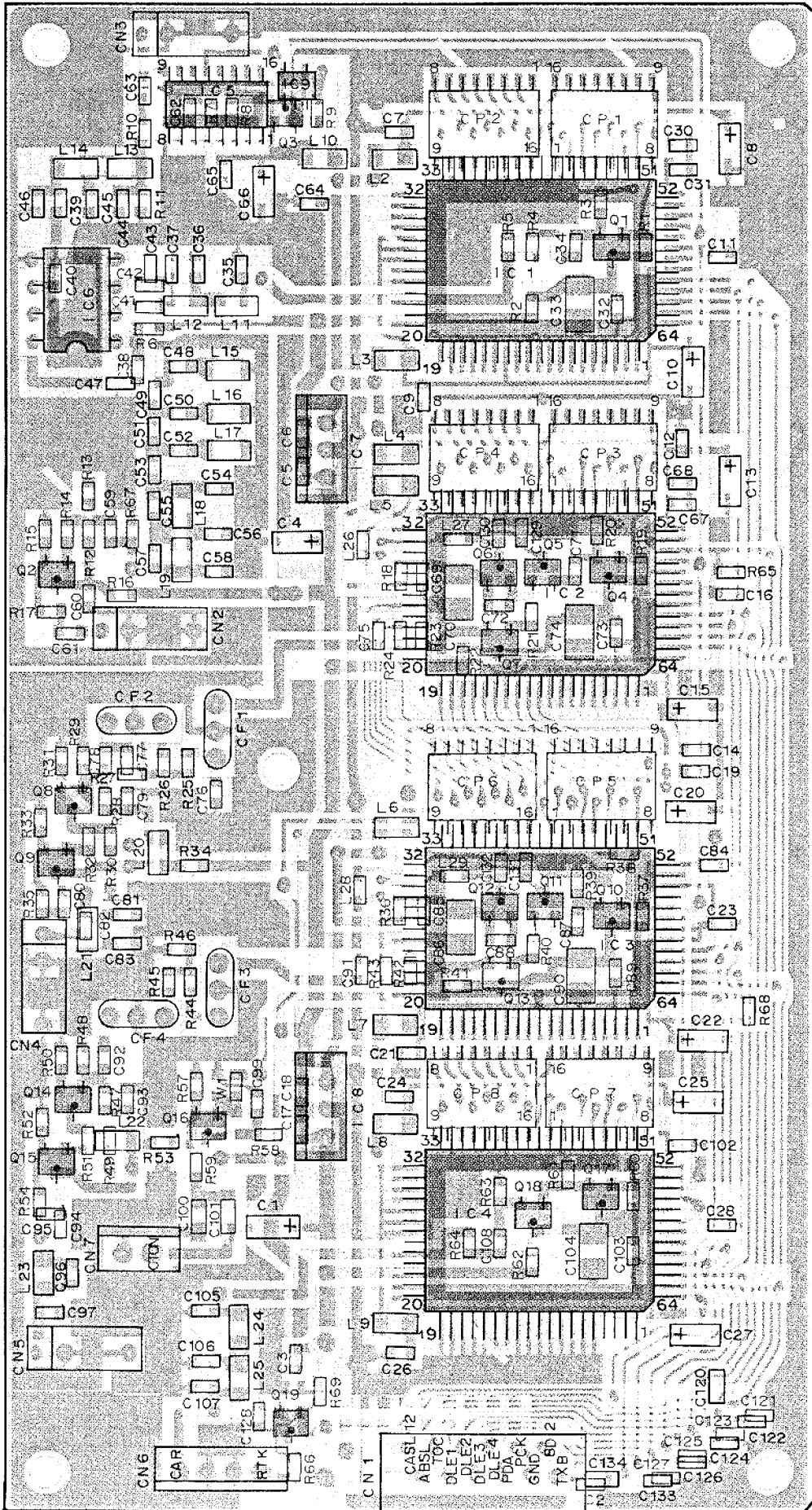

AN78N05

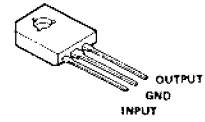

2SC2712(Y)
DTC114EK



2SK508(K53)



SN16913P

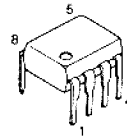

TC7S04F

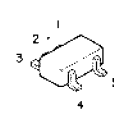

μPD74HC390G

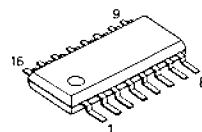

CAR UNIT (X50-3140-00)

CAR UNIT (X50-3140-00)

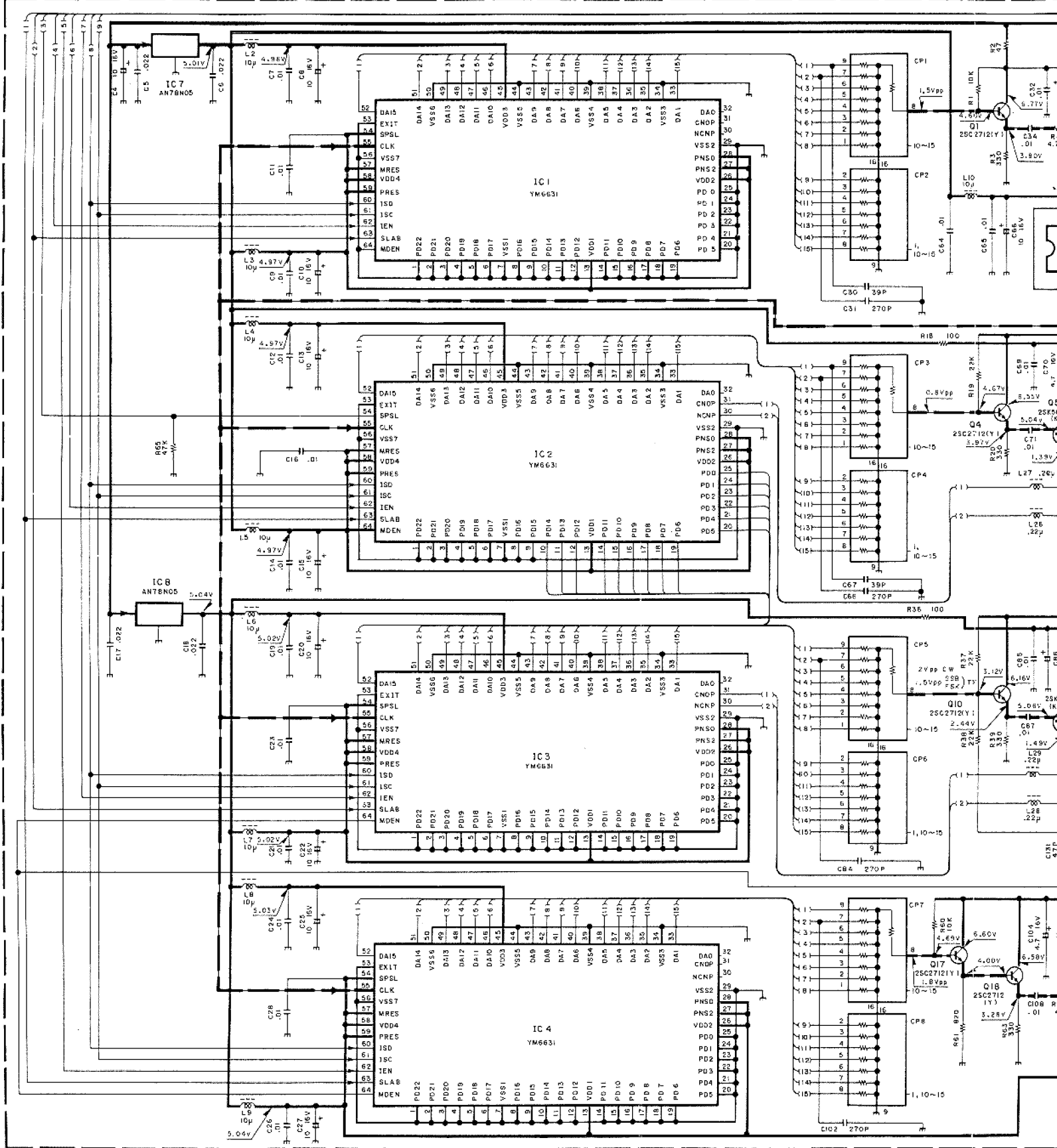

CIRCUIT DIAGRAM TS-850S

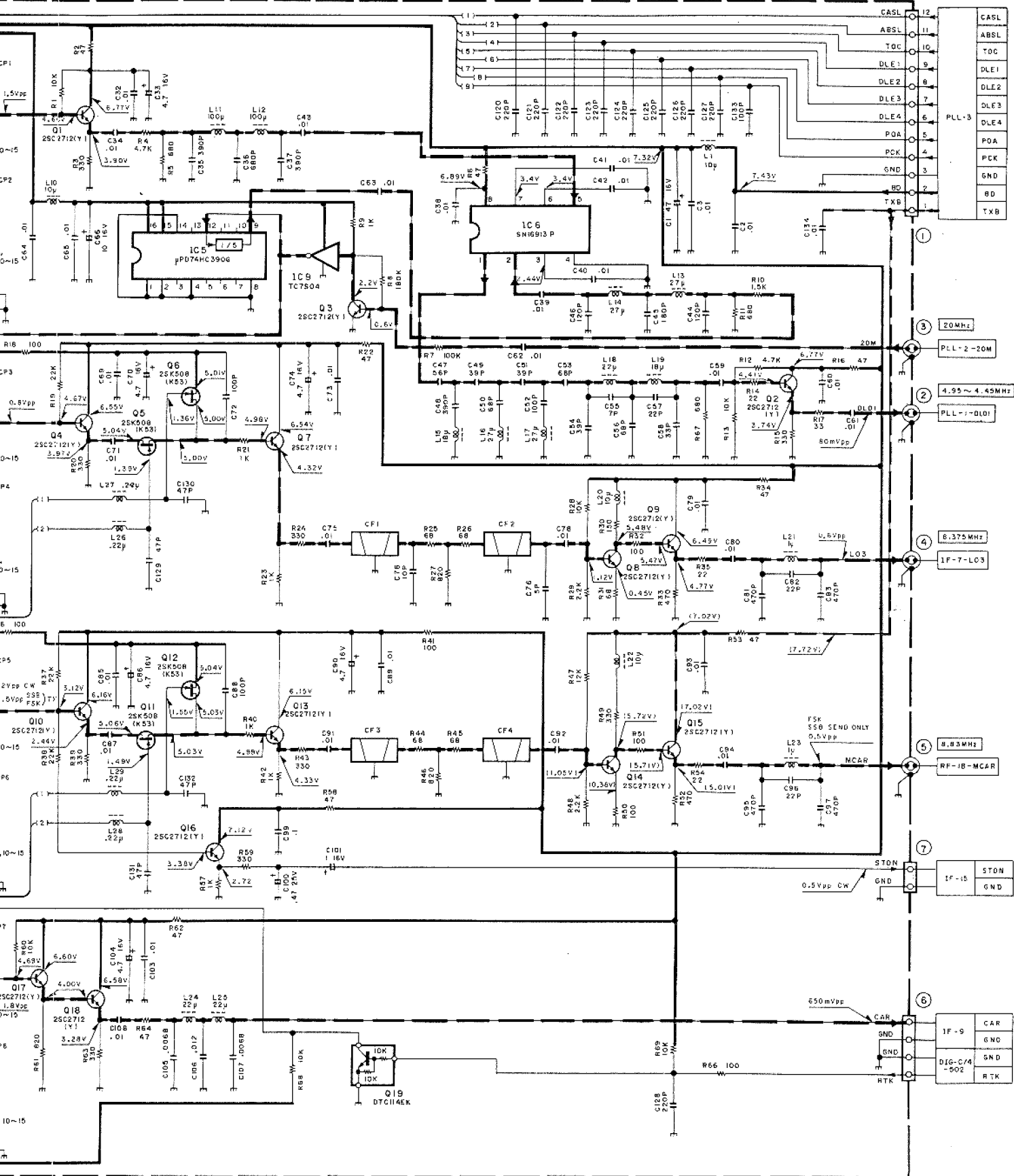

TS-850S PC BOARD VIEWS

FILTER UNIT (X51-3100-00) Component side view

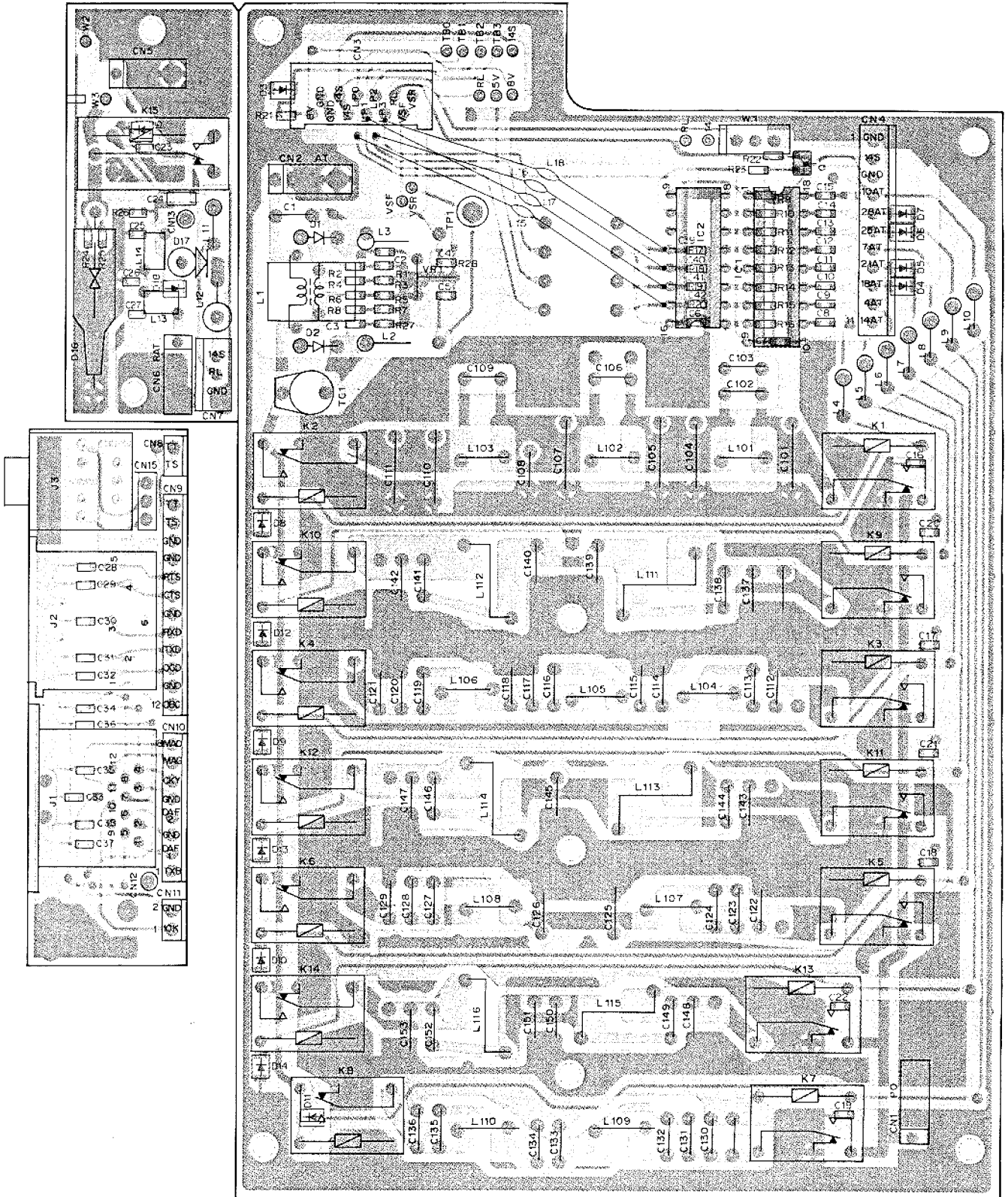

FILTER UNIT (X51-3100-00) Foil side view

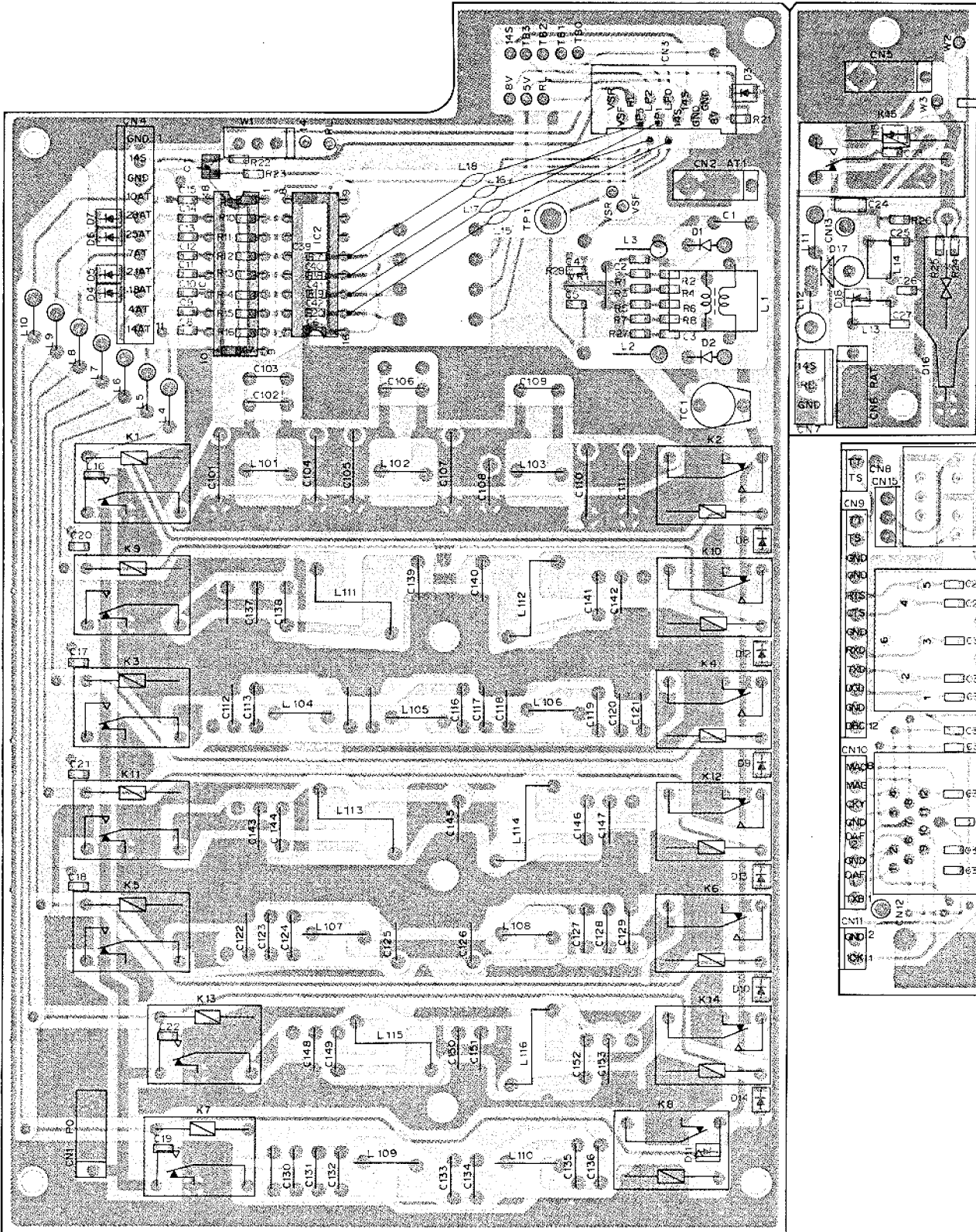

M54581P

SN74LS145N

2SA1162(Y)

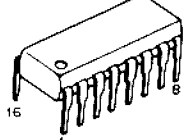
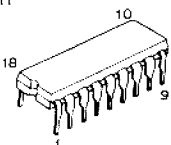

FILTER UNIT (X51-3100-00)

FILTER UNIT (X51-3100-00) (A/3)

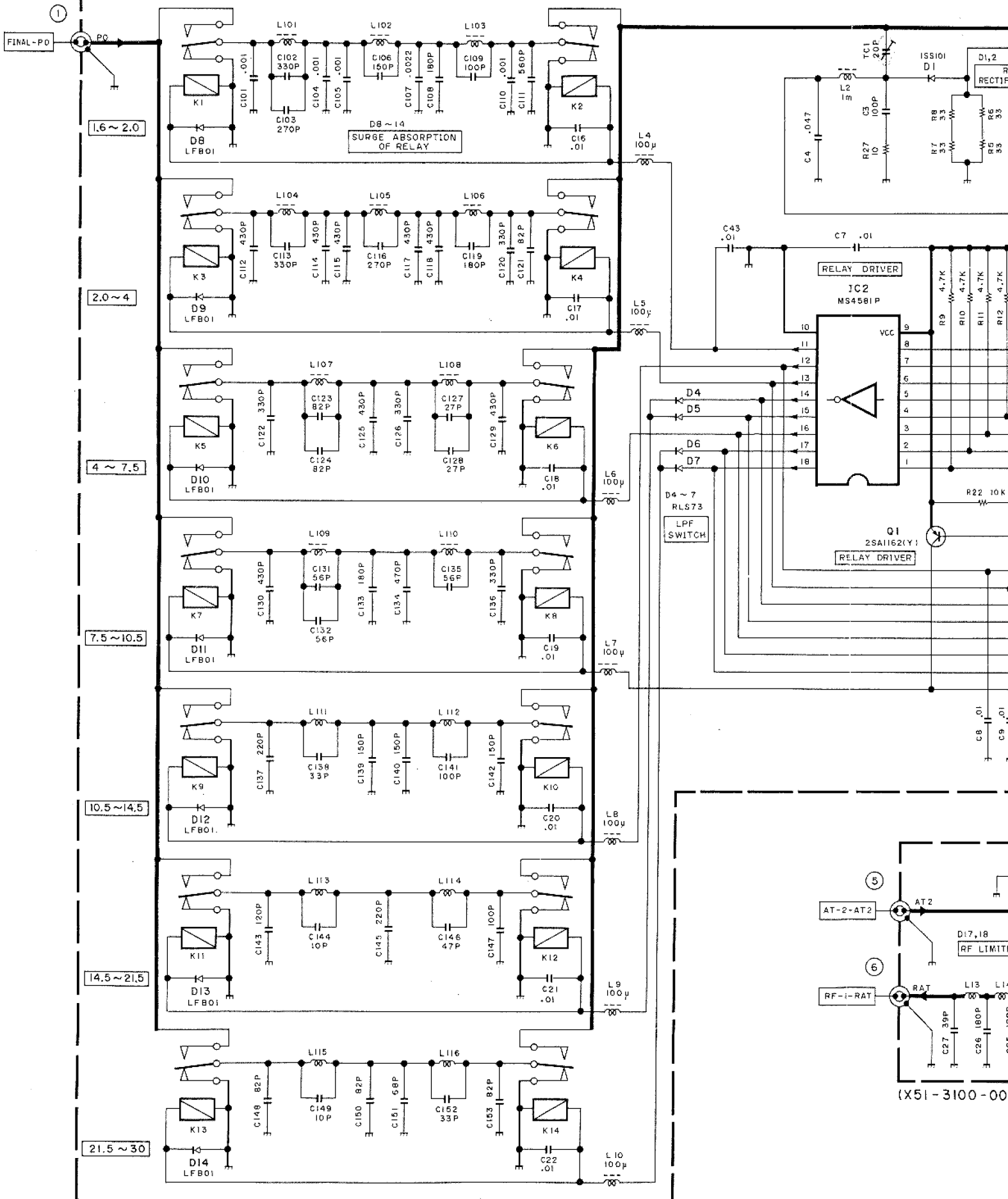

CIRCUIT DIAGRAM TS-850S

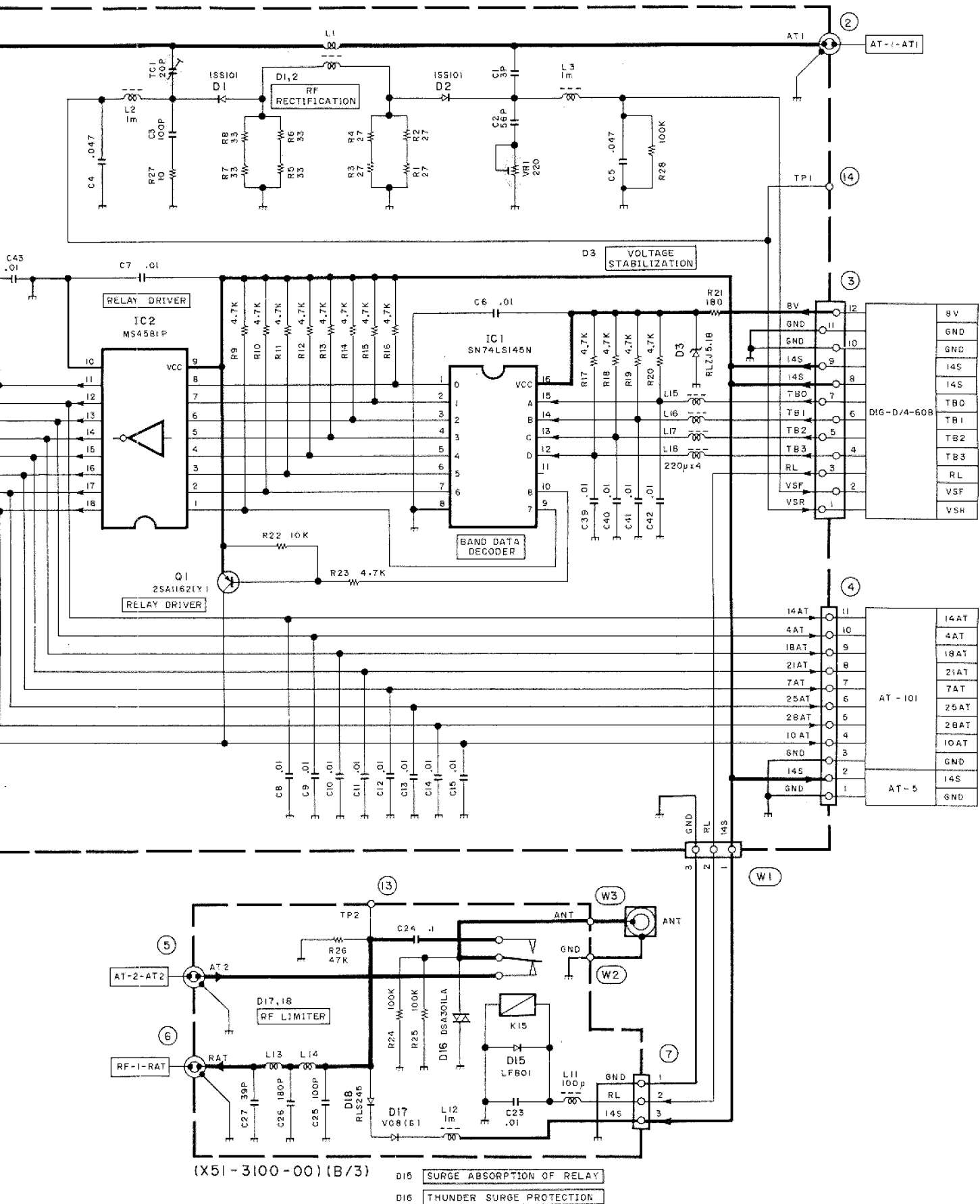

TS-850S PC BOARD VIEWS

AT UNIT/AT-850 (X53-3340-00) Component side view

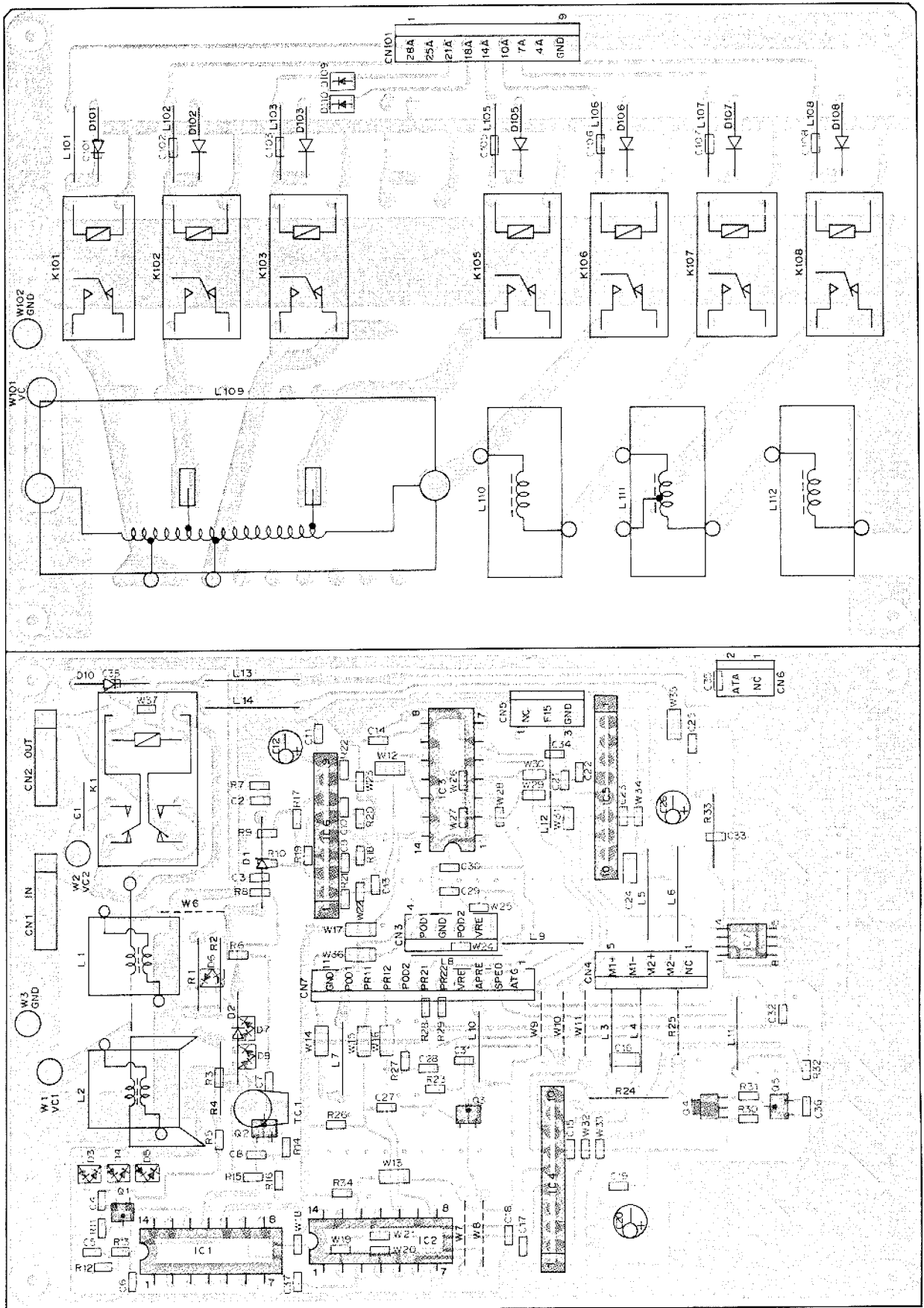

AT UNIT/AT-850 (X53-3340-00) Foil side view

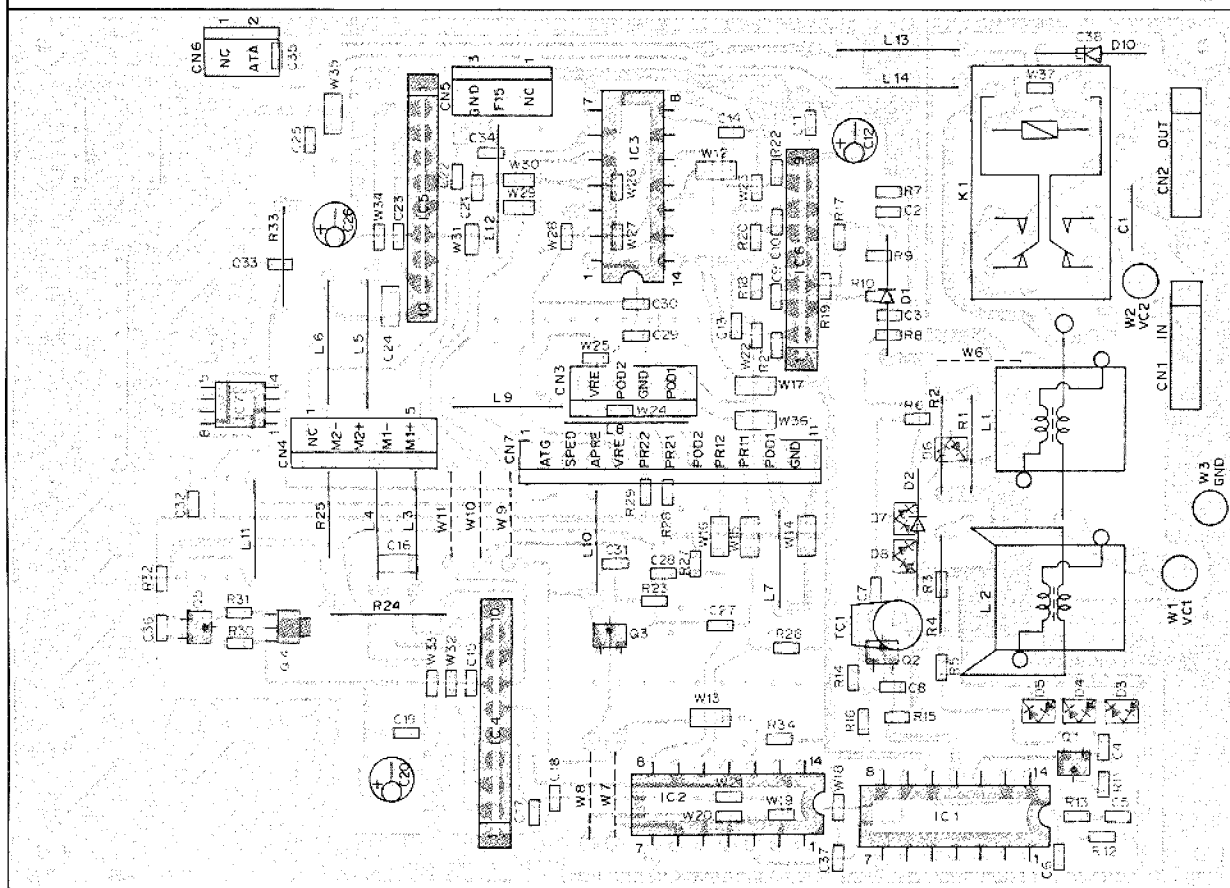
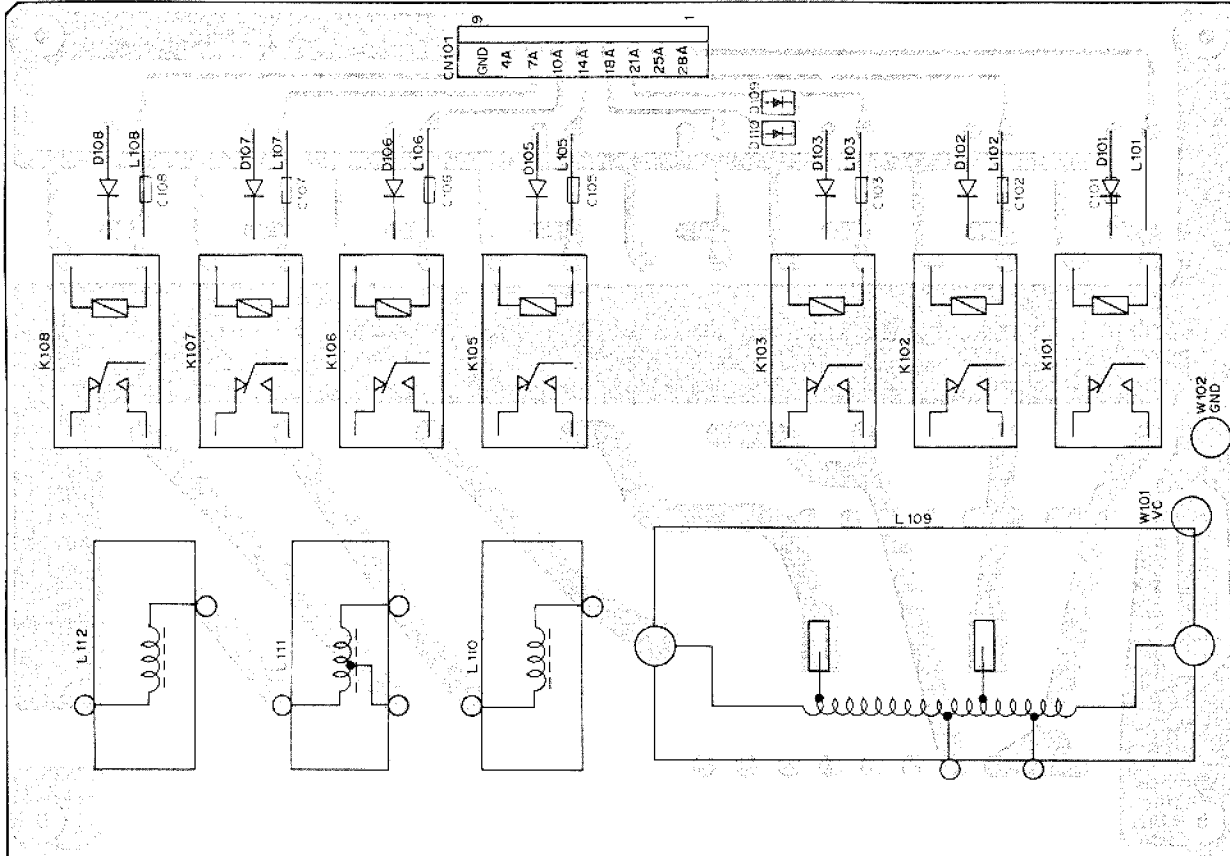

NJM2903S

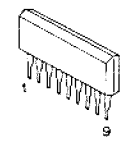

SN74S74N

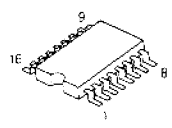

TC4066BP

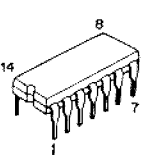

2SA1204(Y)

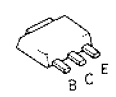

2SC2714(Y)
DTC114EK

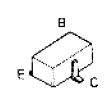

MC78L05M

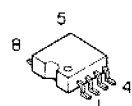

BA6109U2

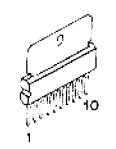

AT UNIT/AT-850 (X53-3340-00) K,P,M,M3,X,E,E3

AT UNIT (X53-3340-00)

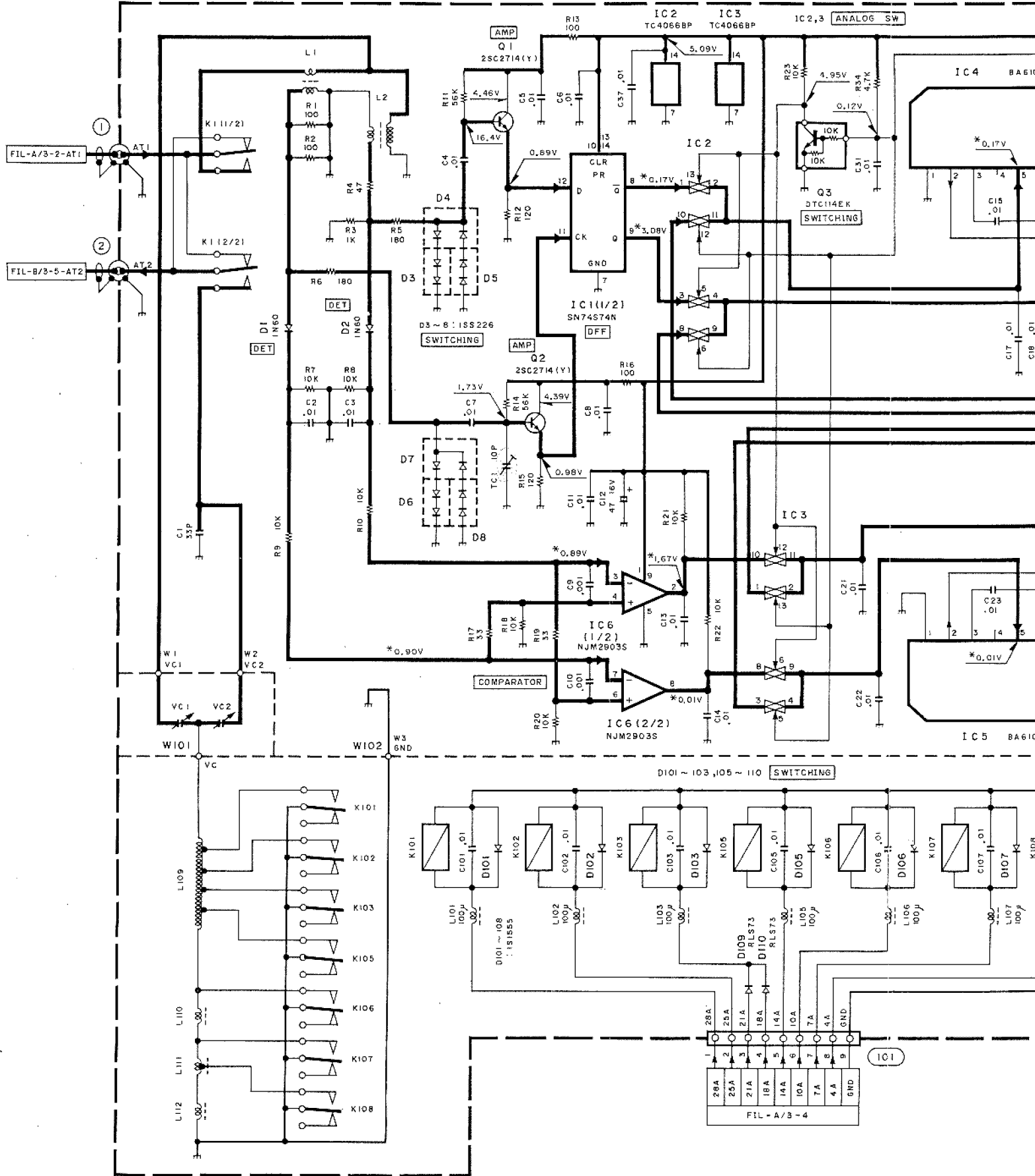

CIRCUIT DIAGRAM TS-850S

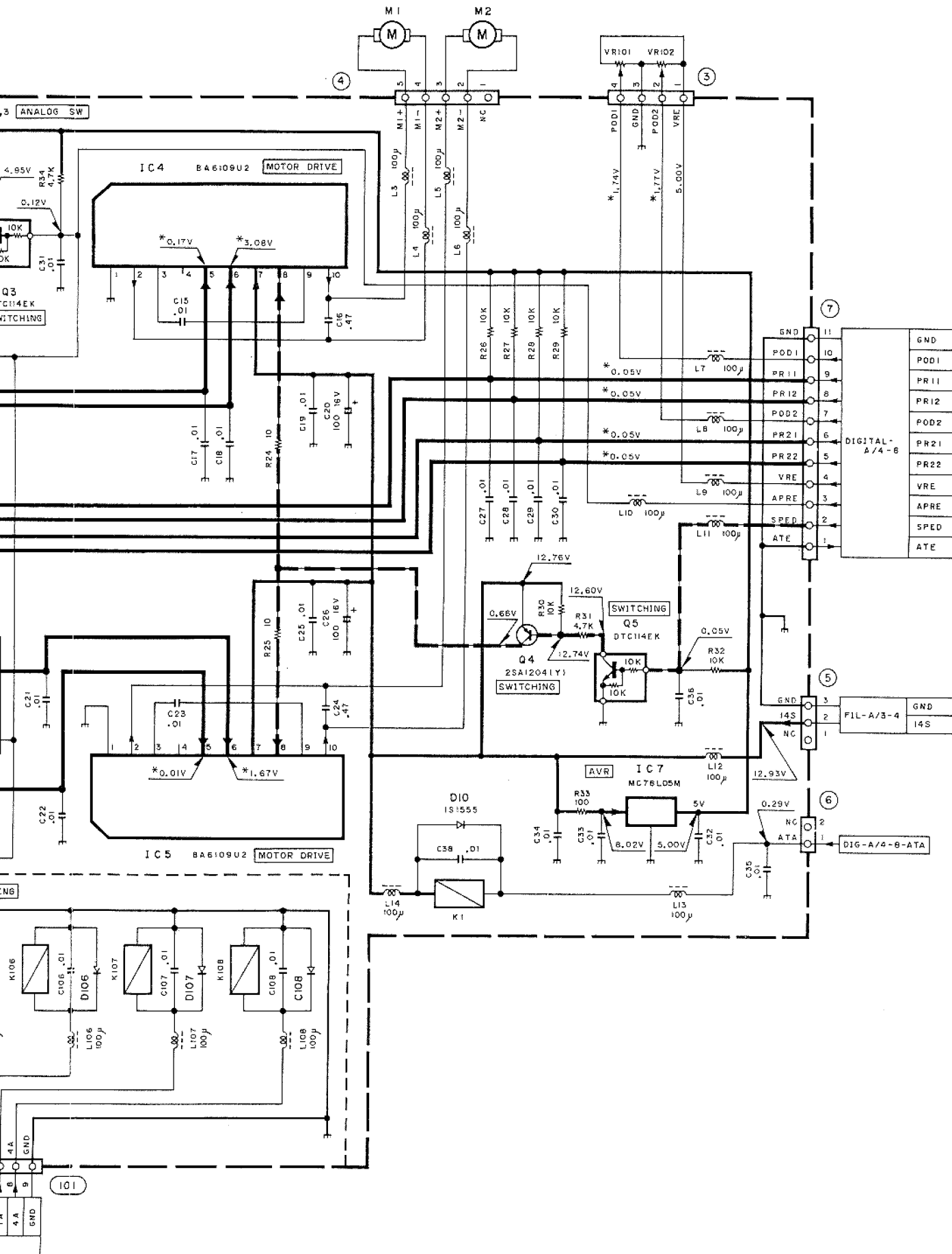

TS-850S CIRCUIT DIAGRAM / PC BOARD VIEWS

LCD ASSY (B38-0350-15)

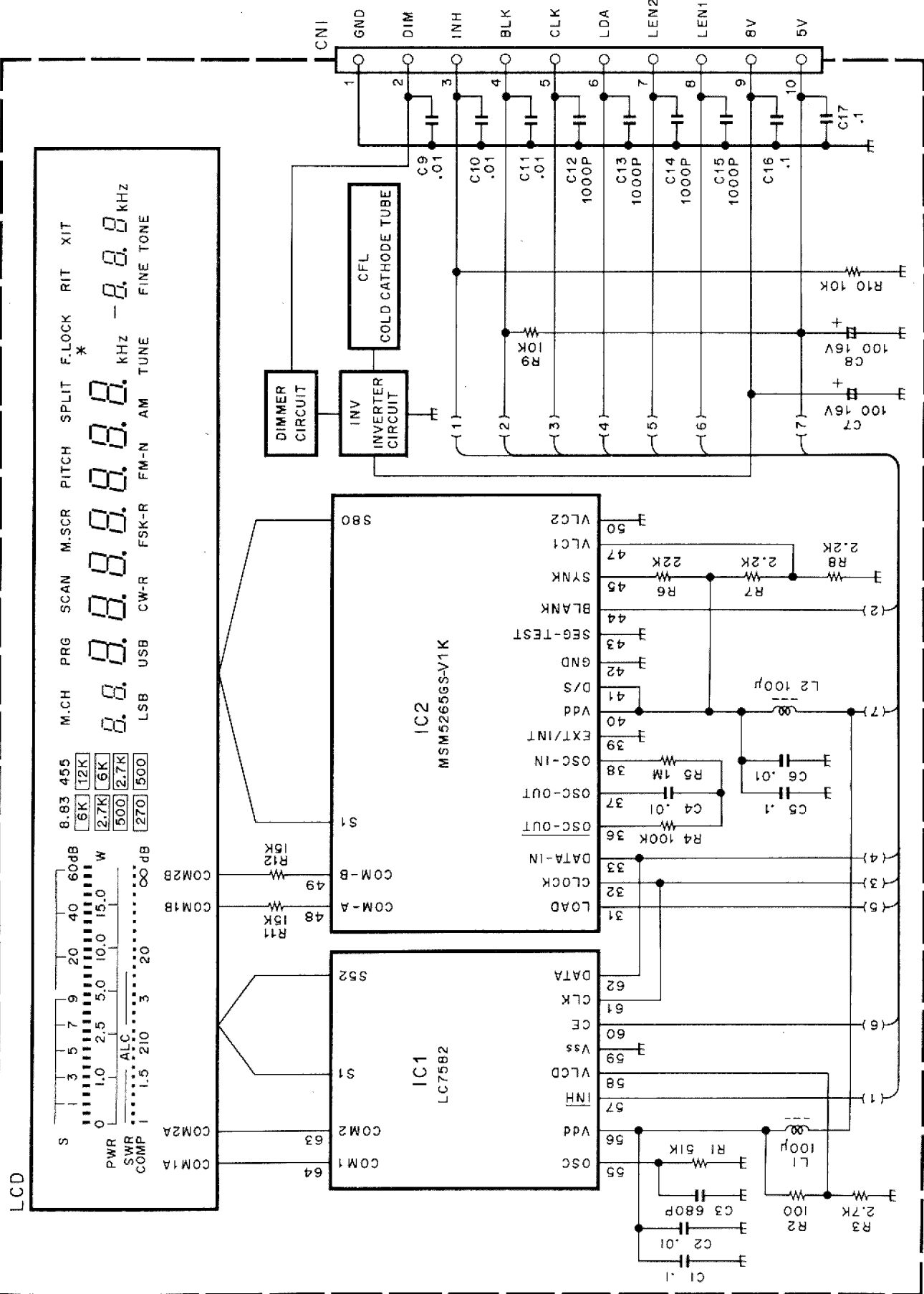

LCD

M.CH PRG SCAN M.SCR PITCH SPLIT F.LOCK RIT XIT
 8.8.8.8.8.8.8.8 kHz - 8.8.8 kHz
 LSB USB CW-R FSK-R FM-N AM TUNE FINE TONE

8.83 455
 5K 12K
 2.7K 6K
 500 2.7K
 270 500
 60dB
 20 40
 1.0 2.5 5.0 10.0 15.0 W
 0 1.5 210 3 20 dB
 ALC
 PWR SWR COMP 1
 COM1A COM2A COM1B COM2B

LCD

LCD ASSY (B38-0350-15) Component side view

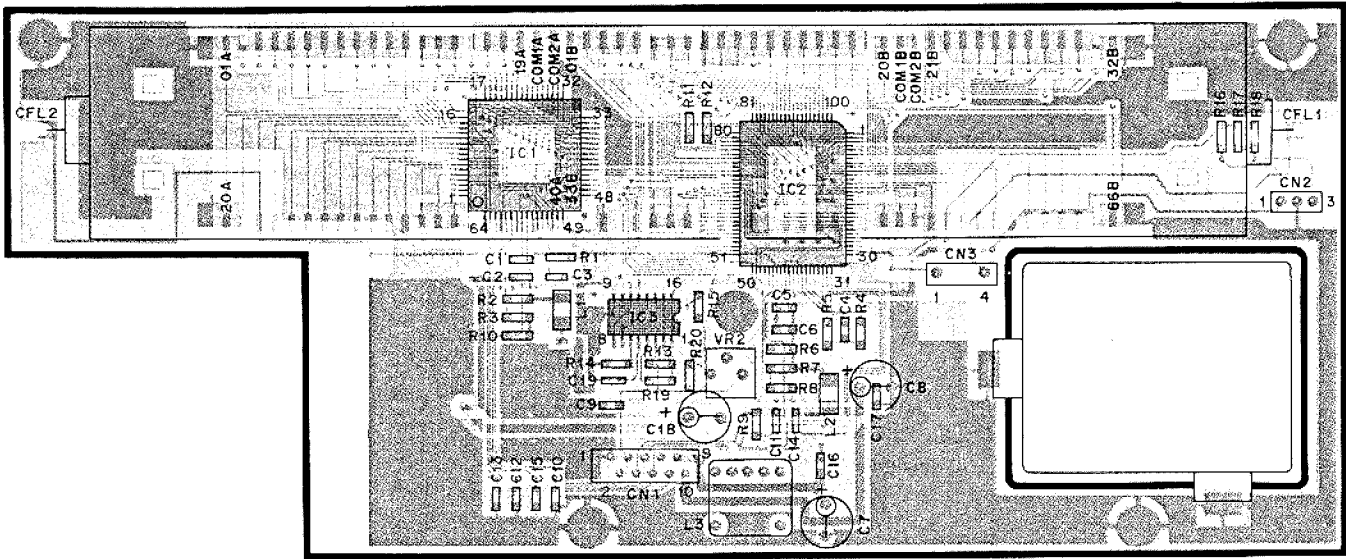

LCD ASSY (B38-0350-15) Foil side view

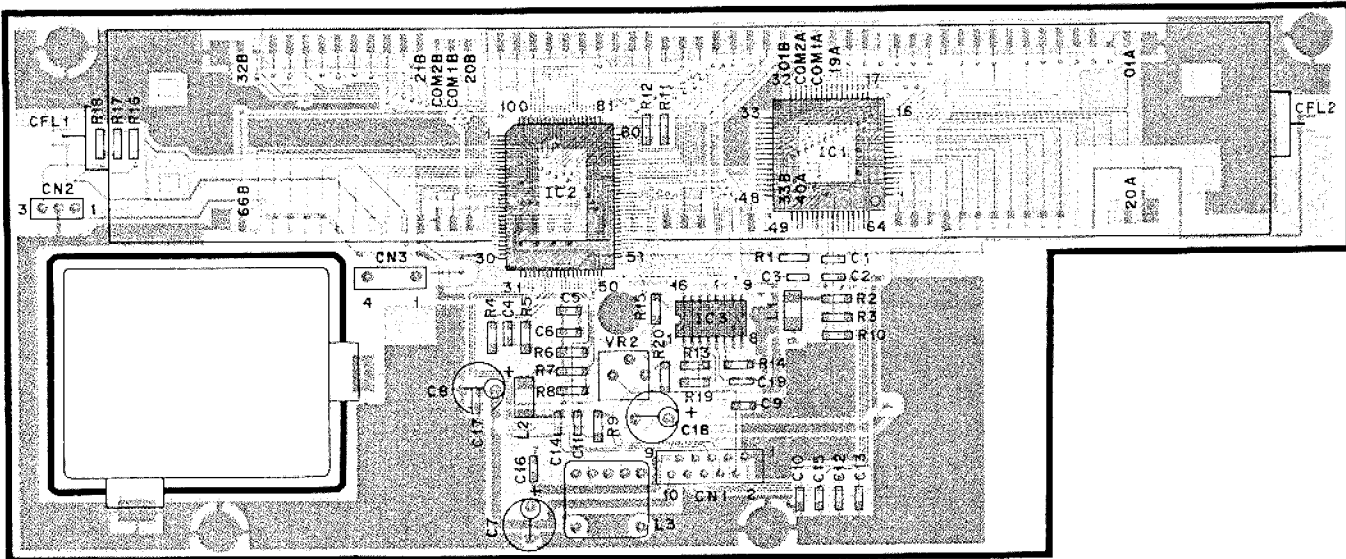

DTA143EK
DTC143EK

MSM5265GS-V1K

LC7582

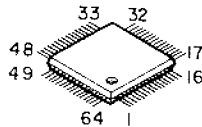
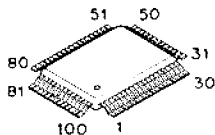

SWITCH UNIT A (X41-3130-00) Component side view

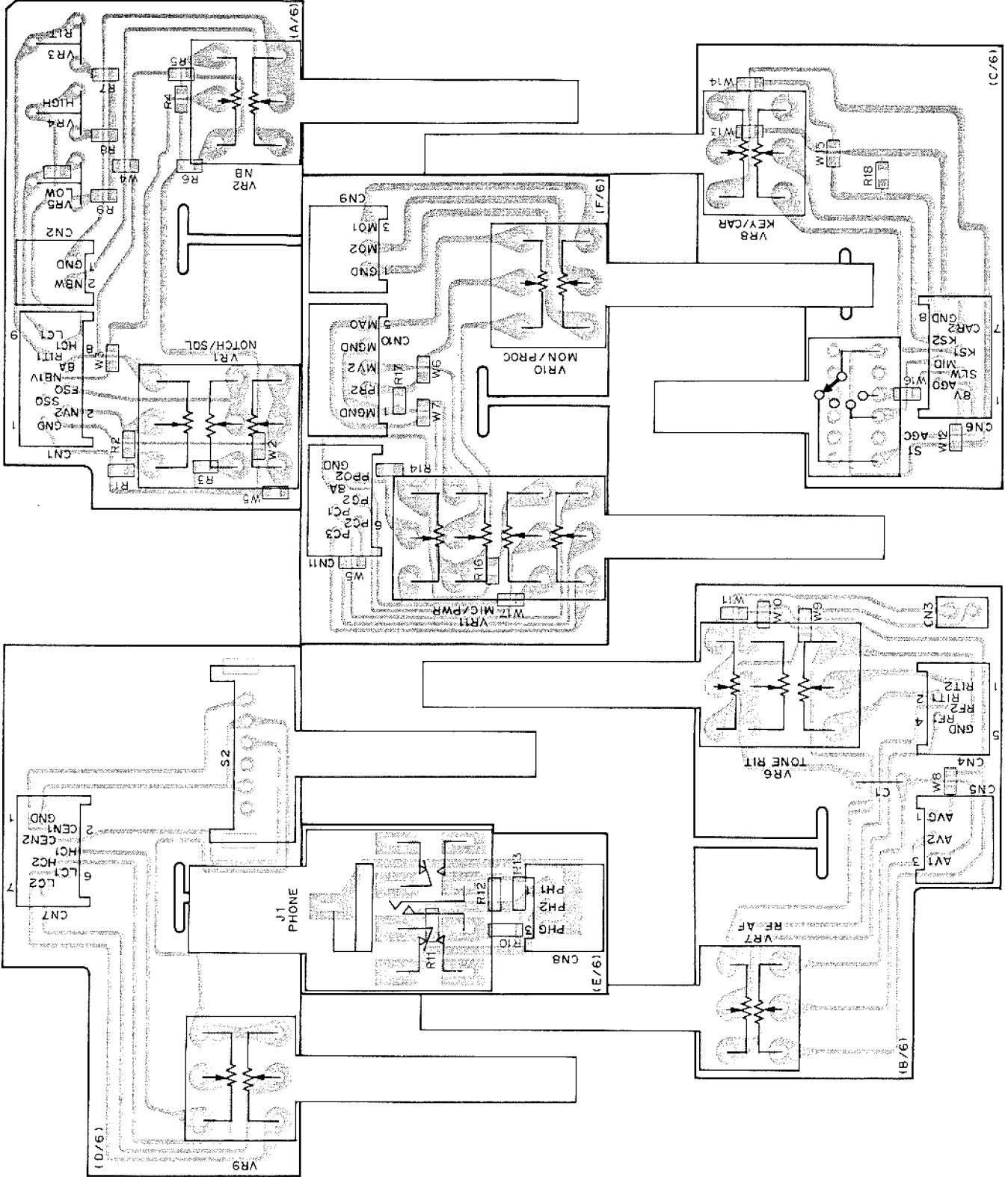

SWITCH UNIT A (X41-3130-00) Foil side view

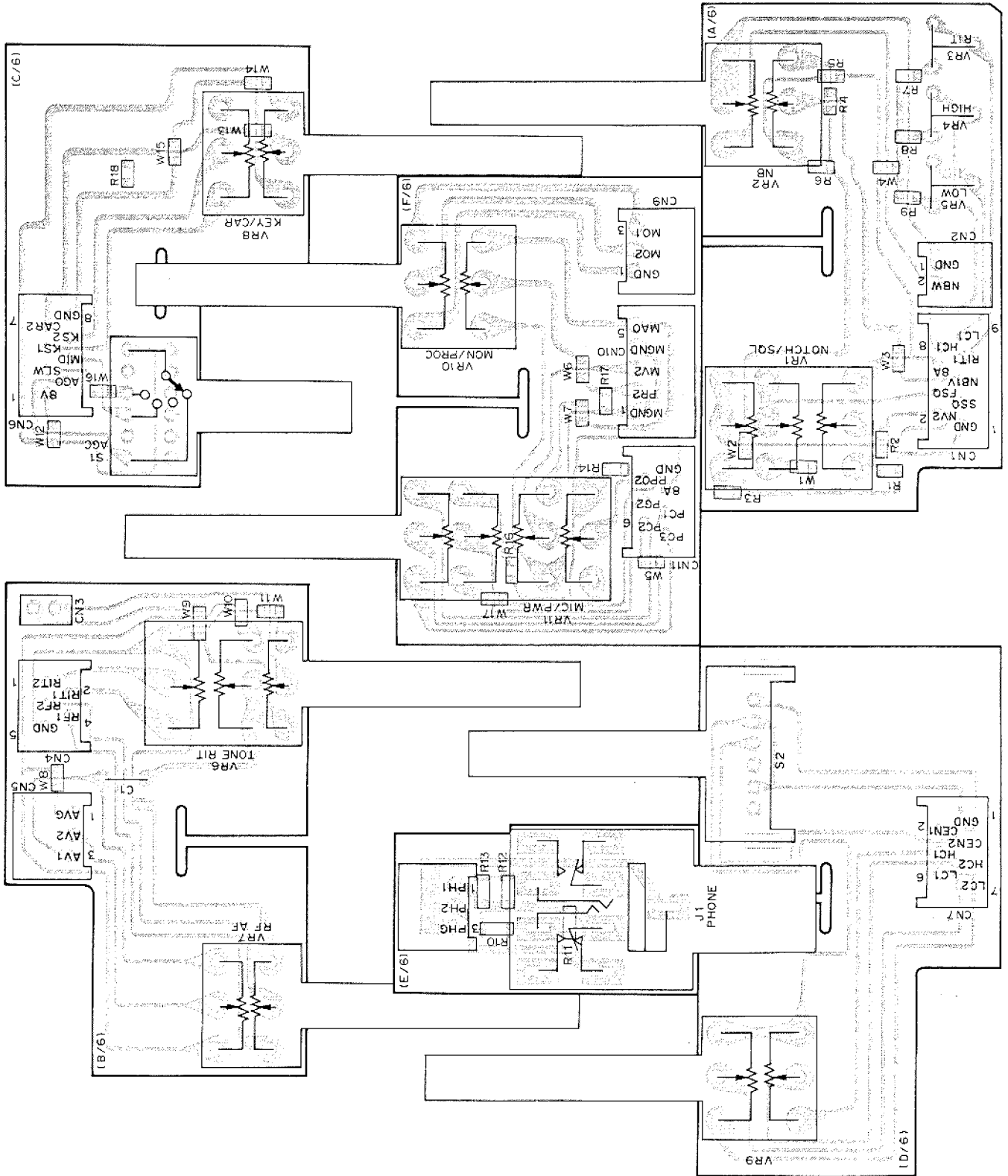

SWITCH UNIT B (X41-3140-00) Component side view

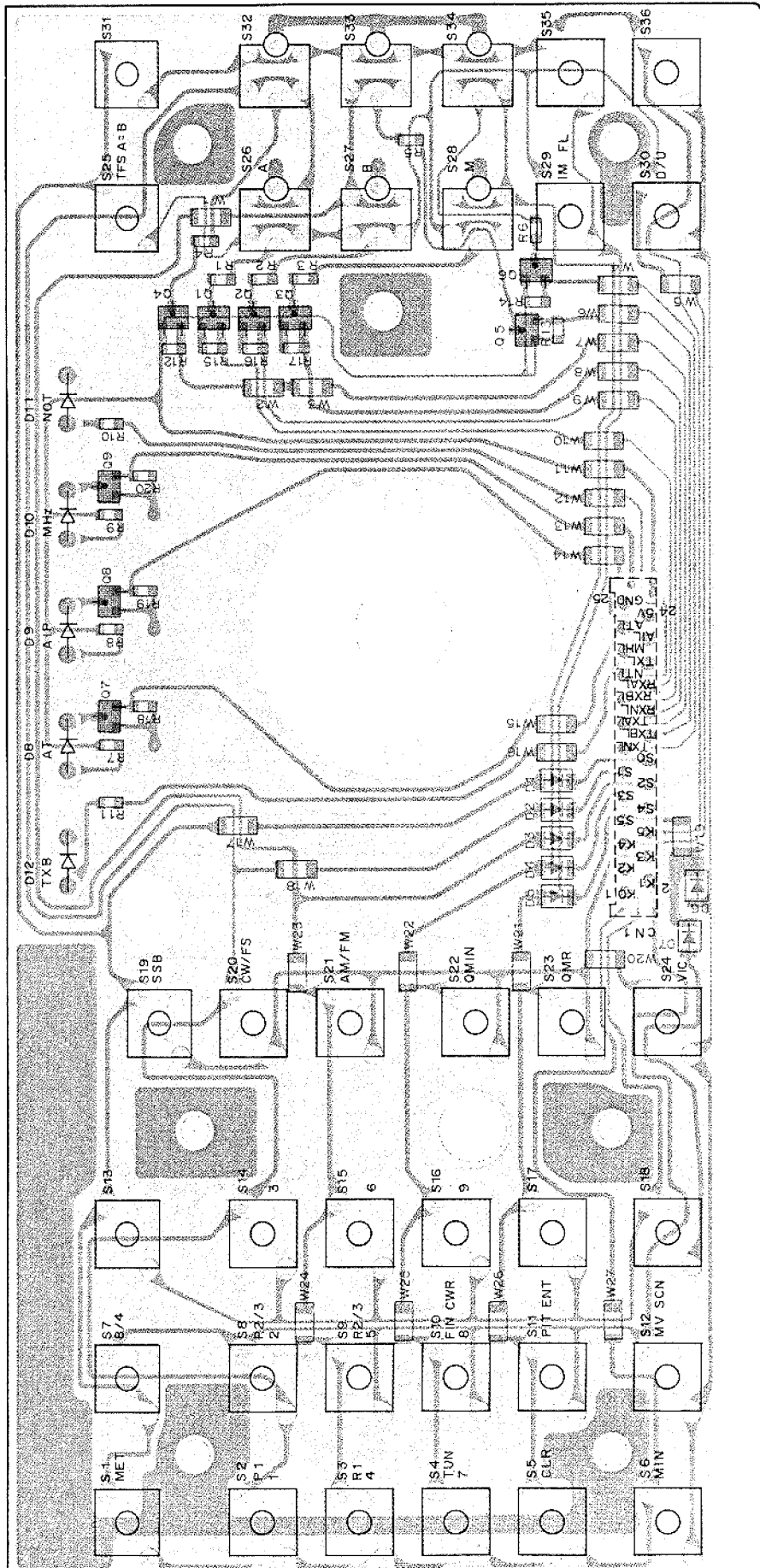

PC BOARD VIEWS TS-850S

SWITCH UNIT B (X41-3140-00) Foil side view

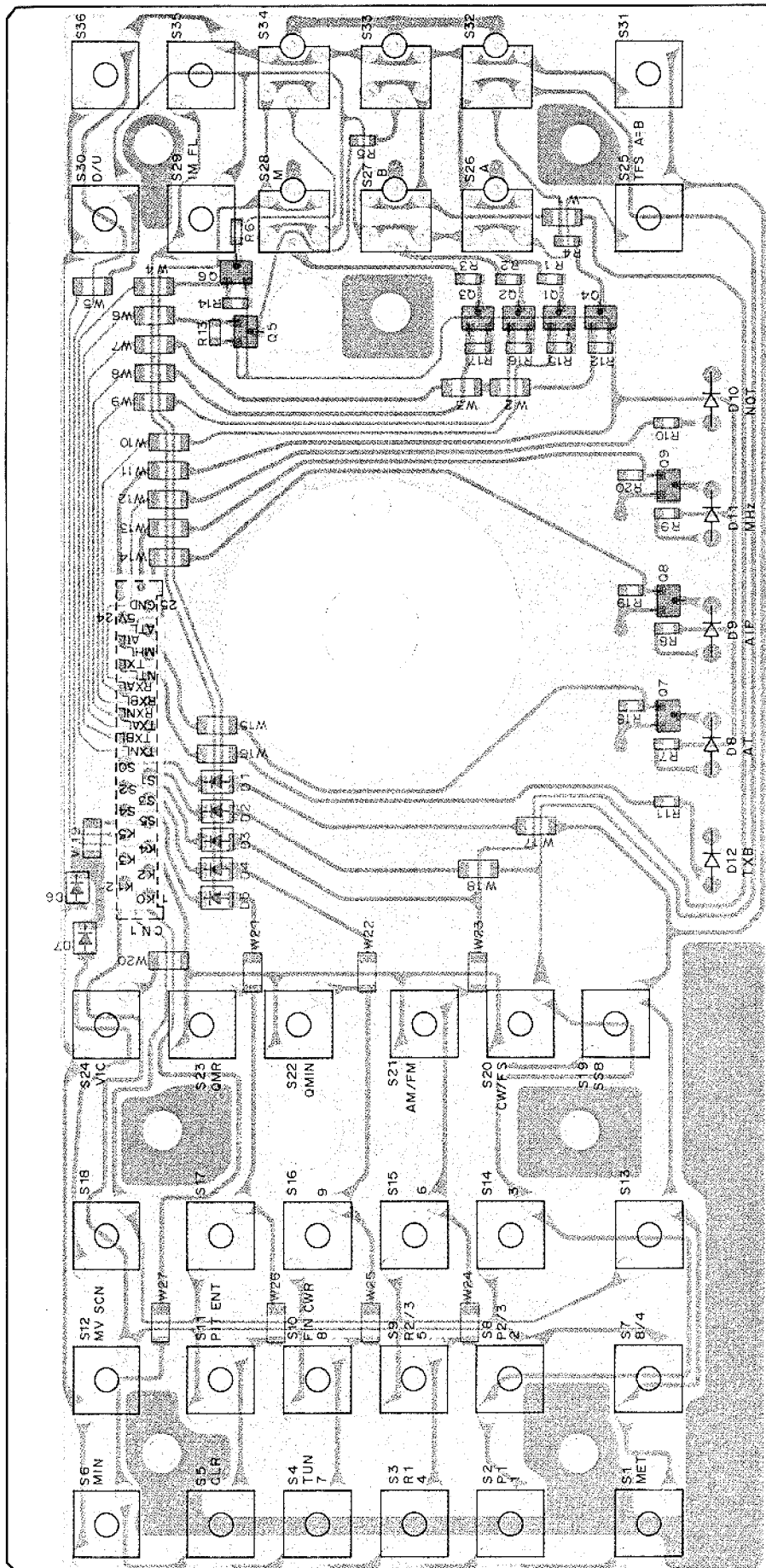

TS-850S SCHEMATIC DIAGRAM

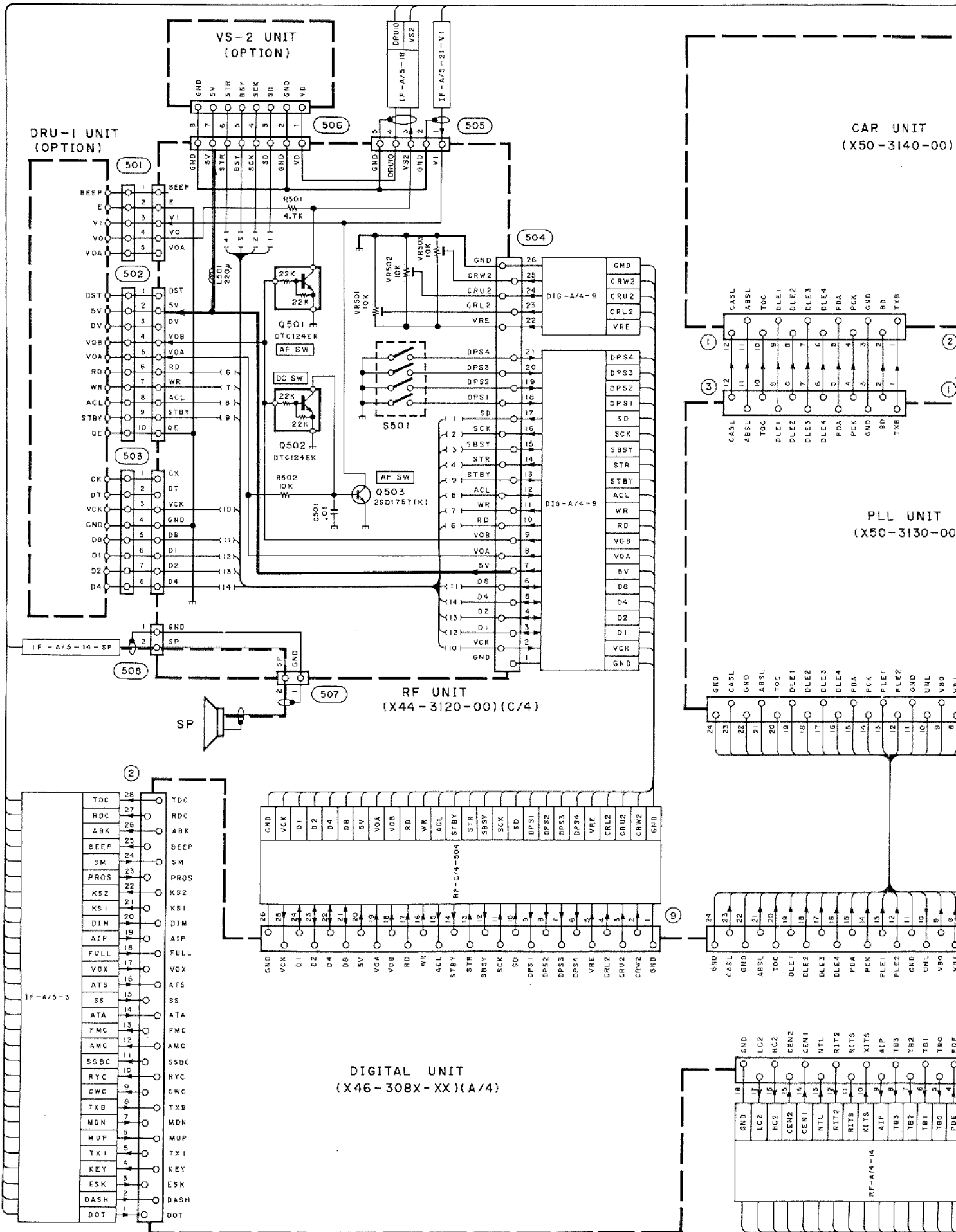

CAR UNIT (X50-3140-00)

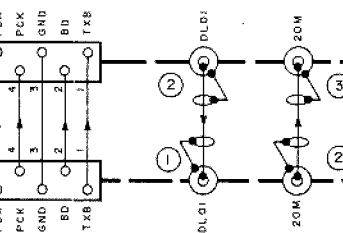

PLL UNIT (X50-3130-00)

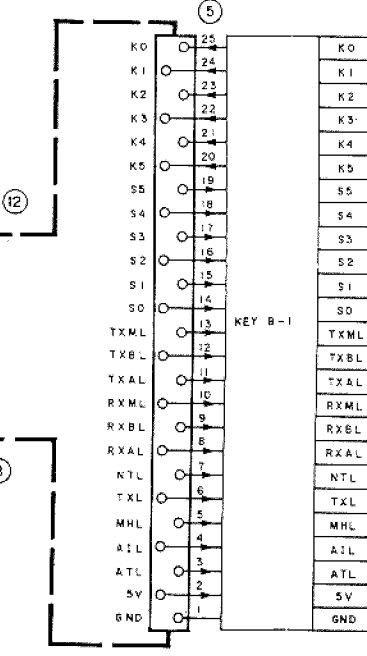
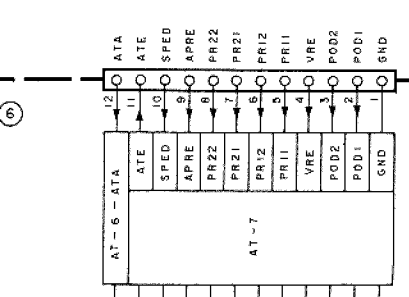
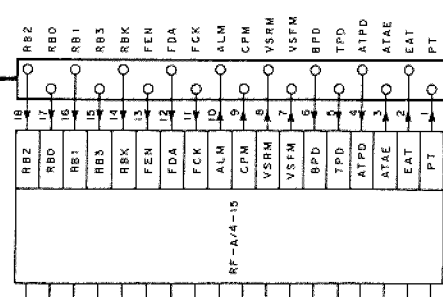
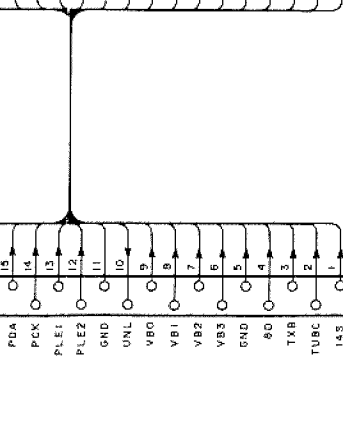
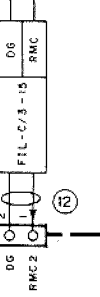
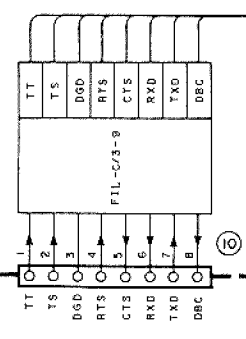
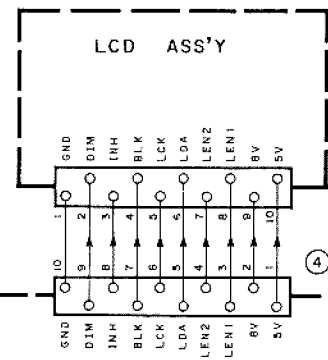
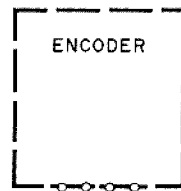
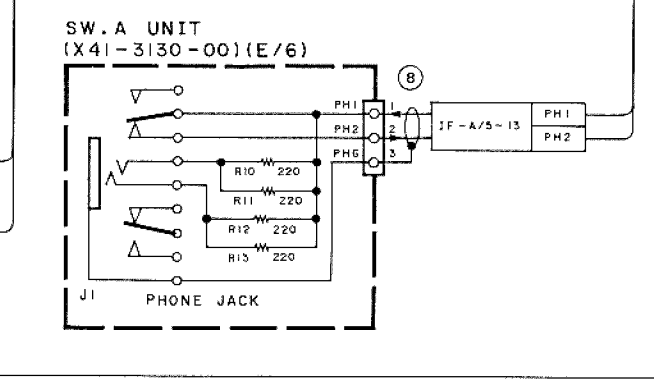
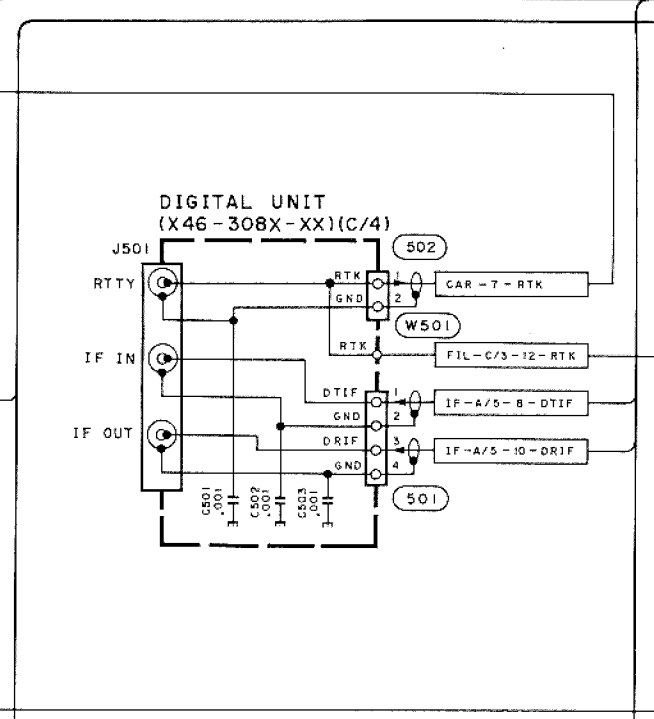
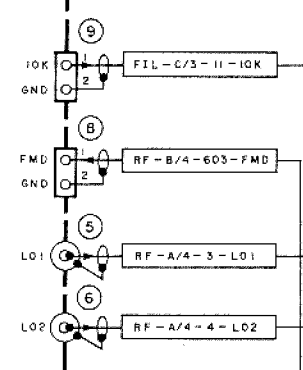
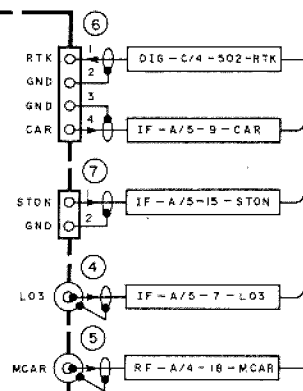
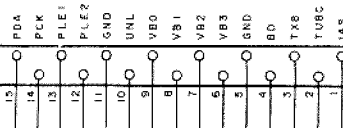

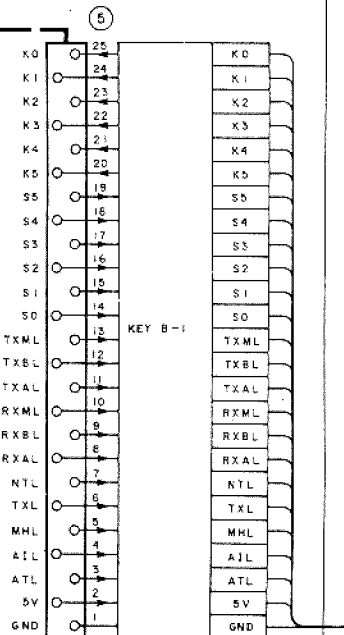
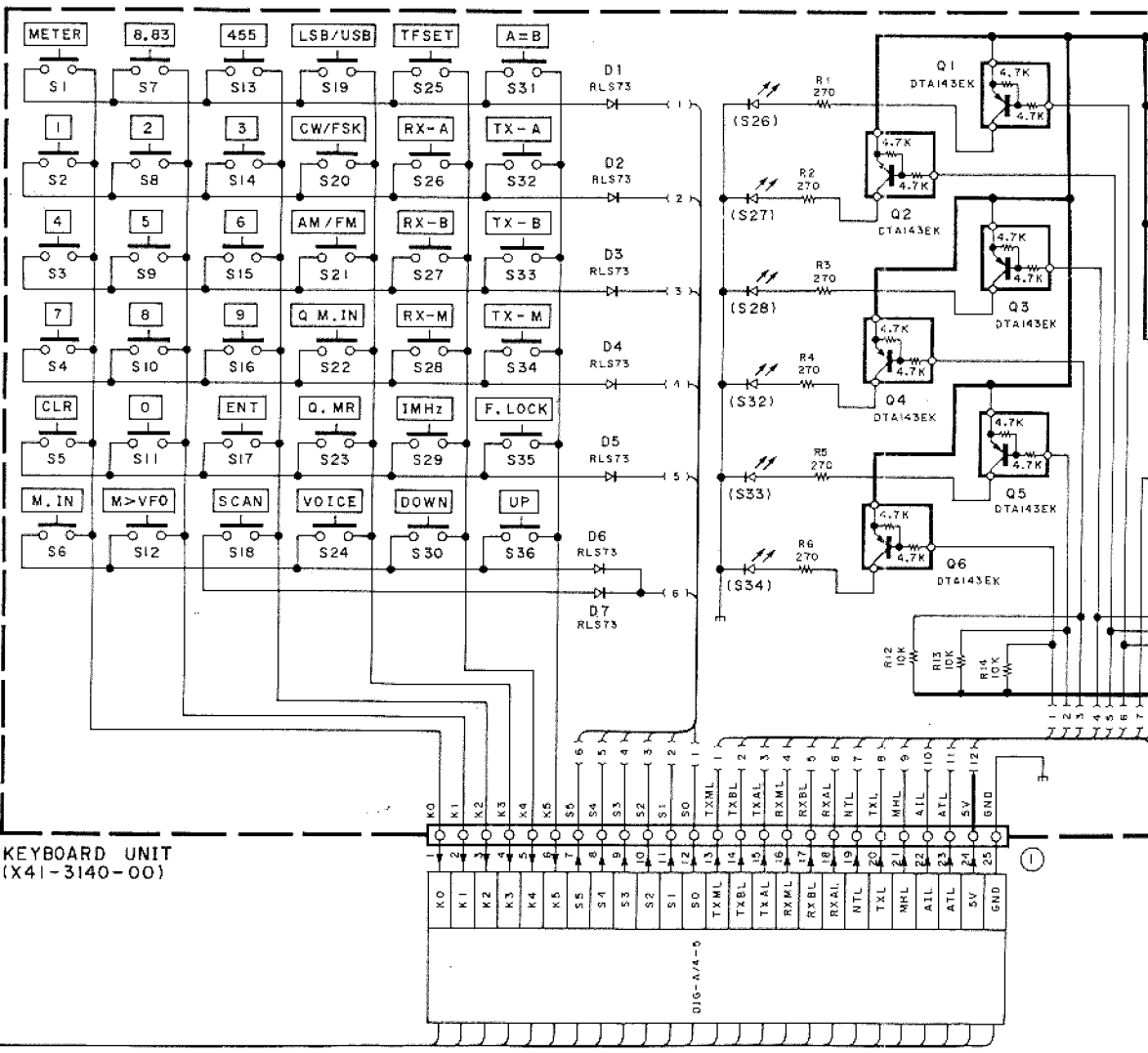
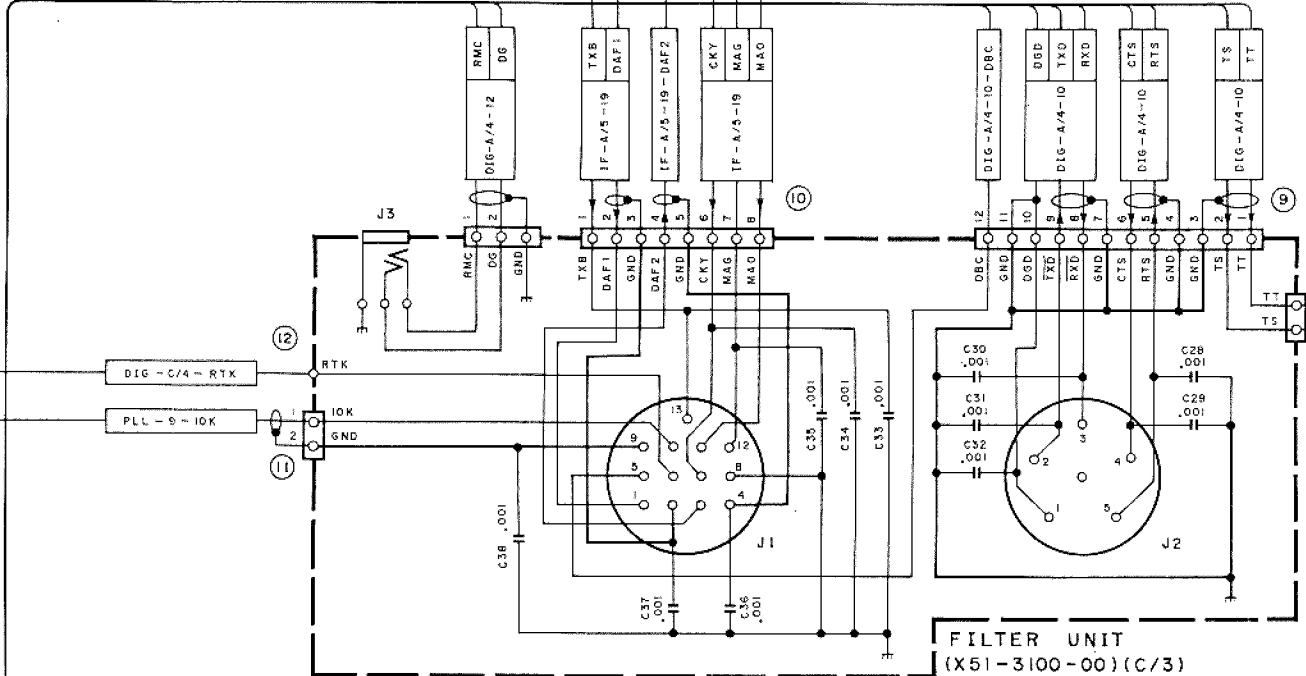

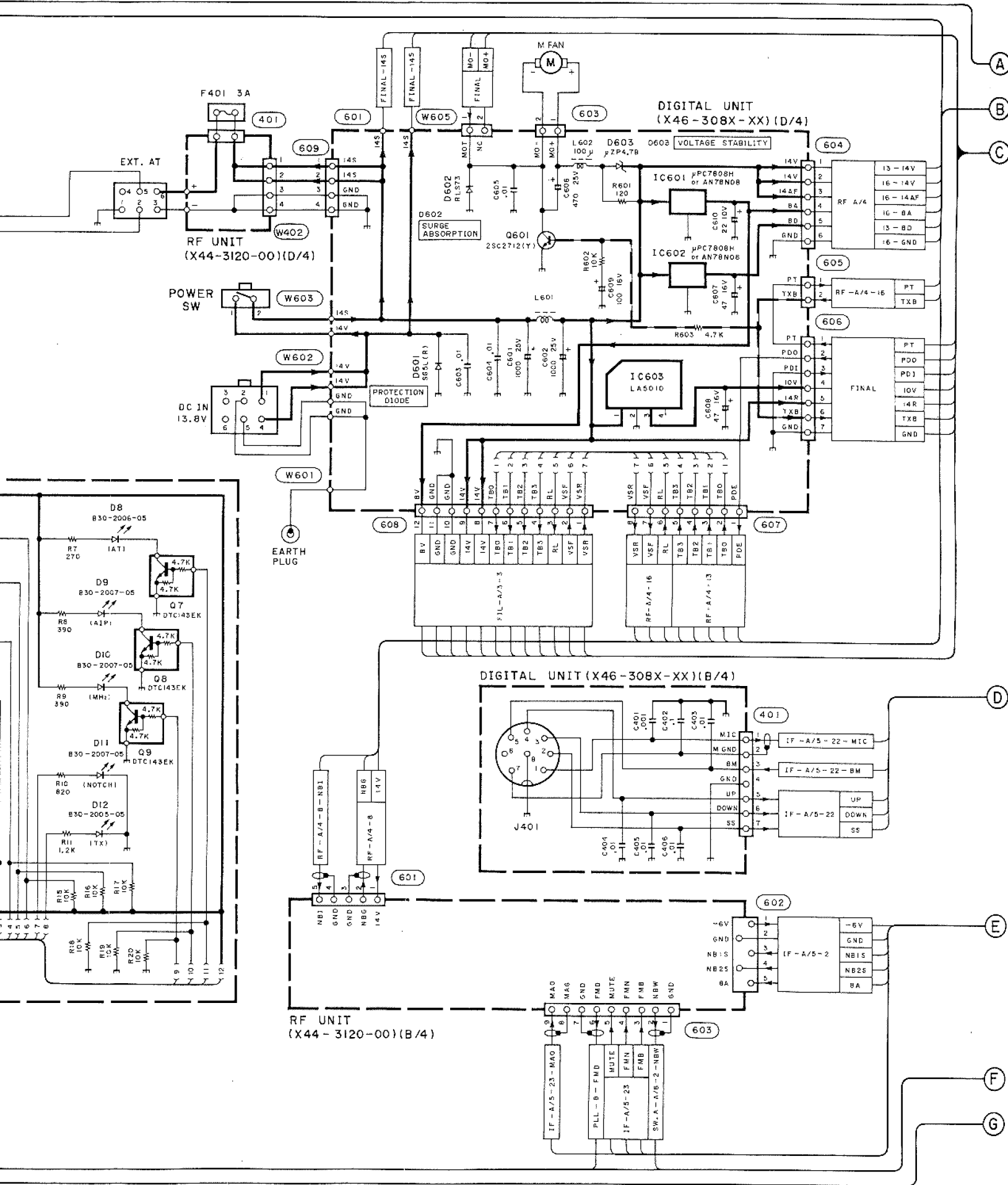

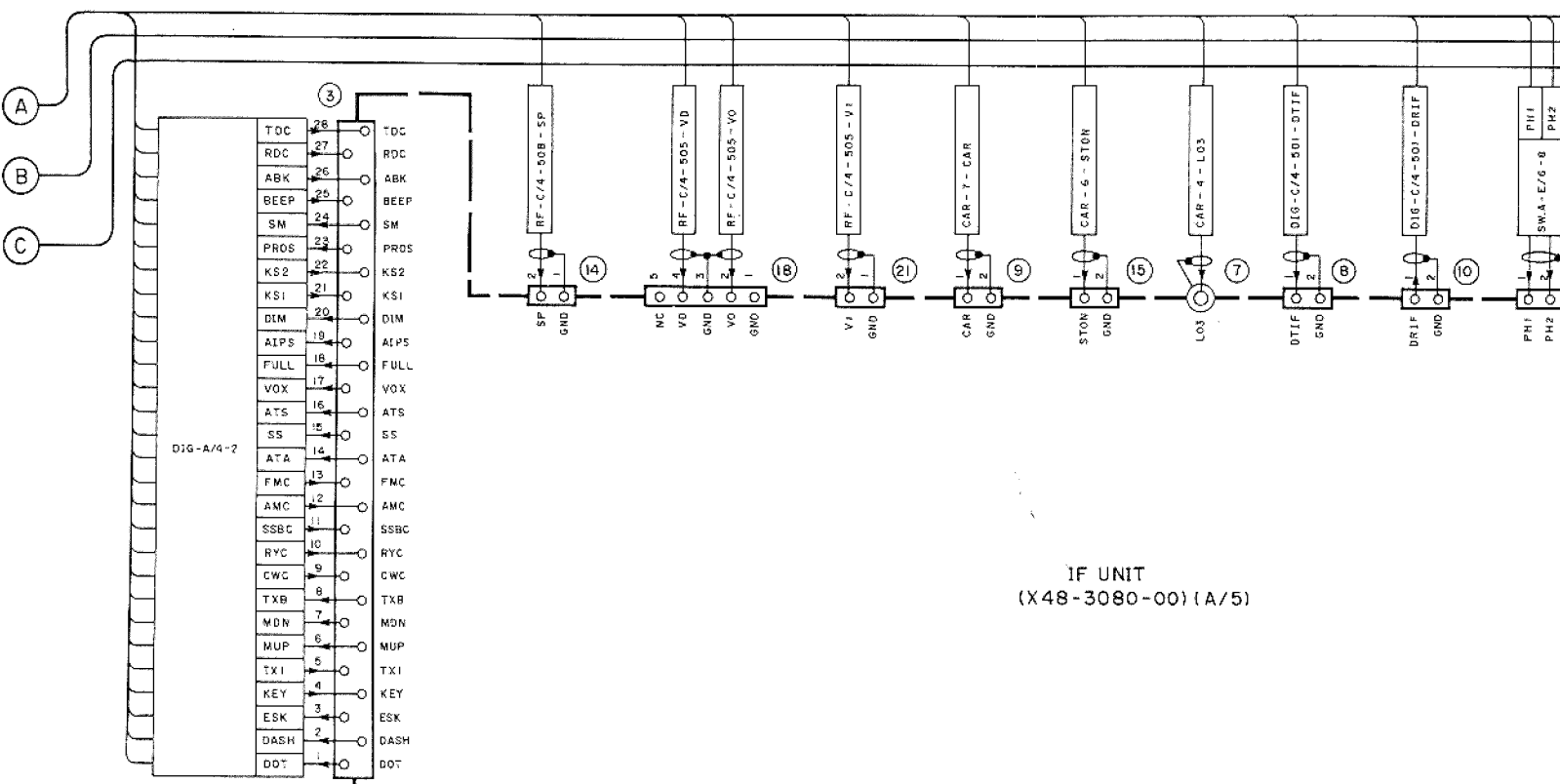

IF UNIT
(X48-3080-00) (A/5)

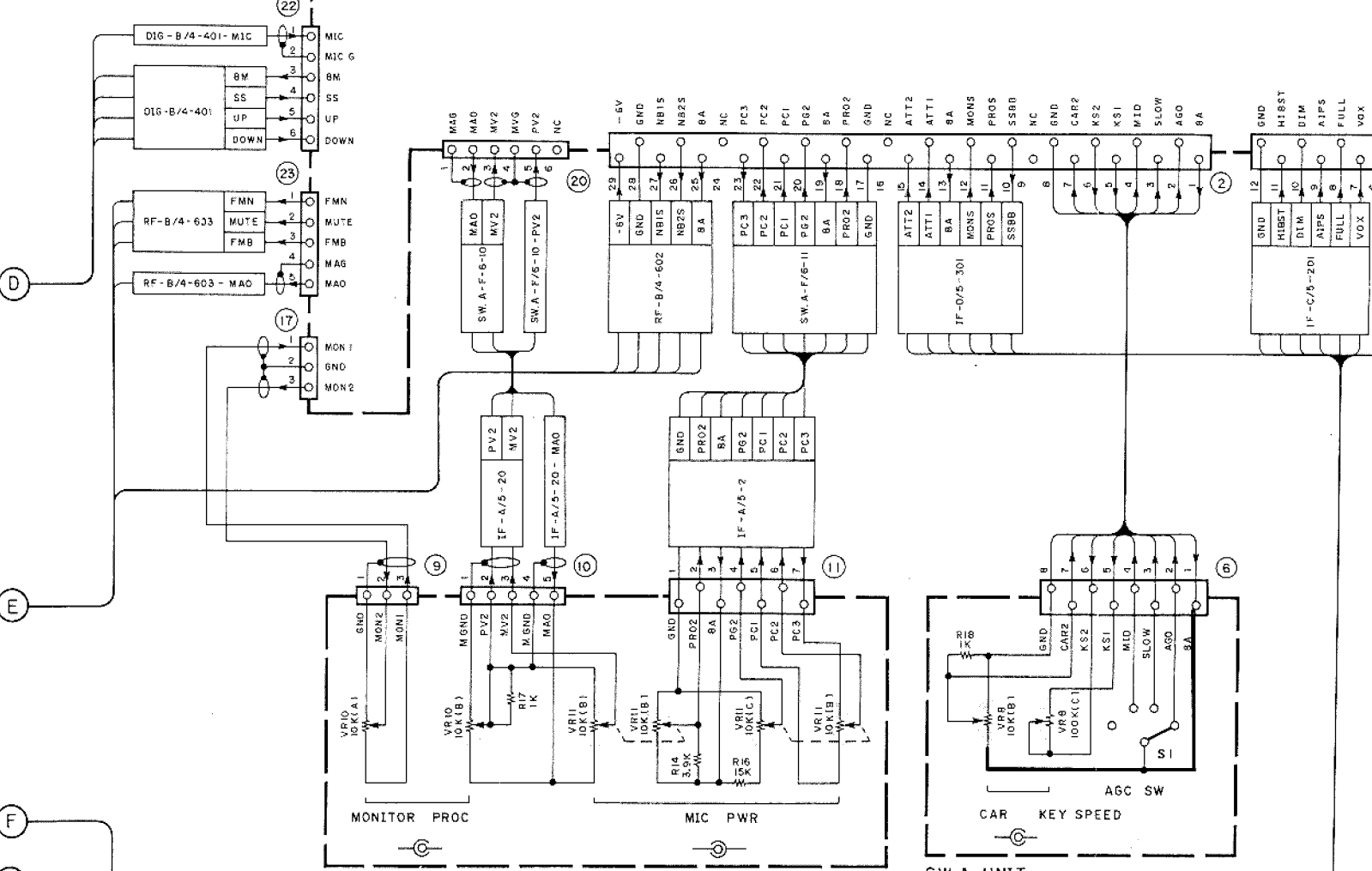

SW.A UNIT (X41-3130-00) (F/6)

SW.A UNIT
(X41-3130-00) (C/6)

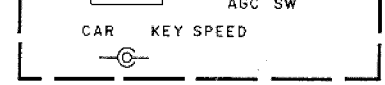

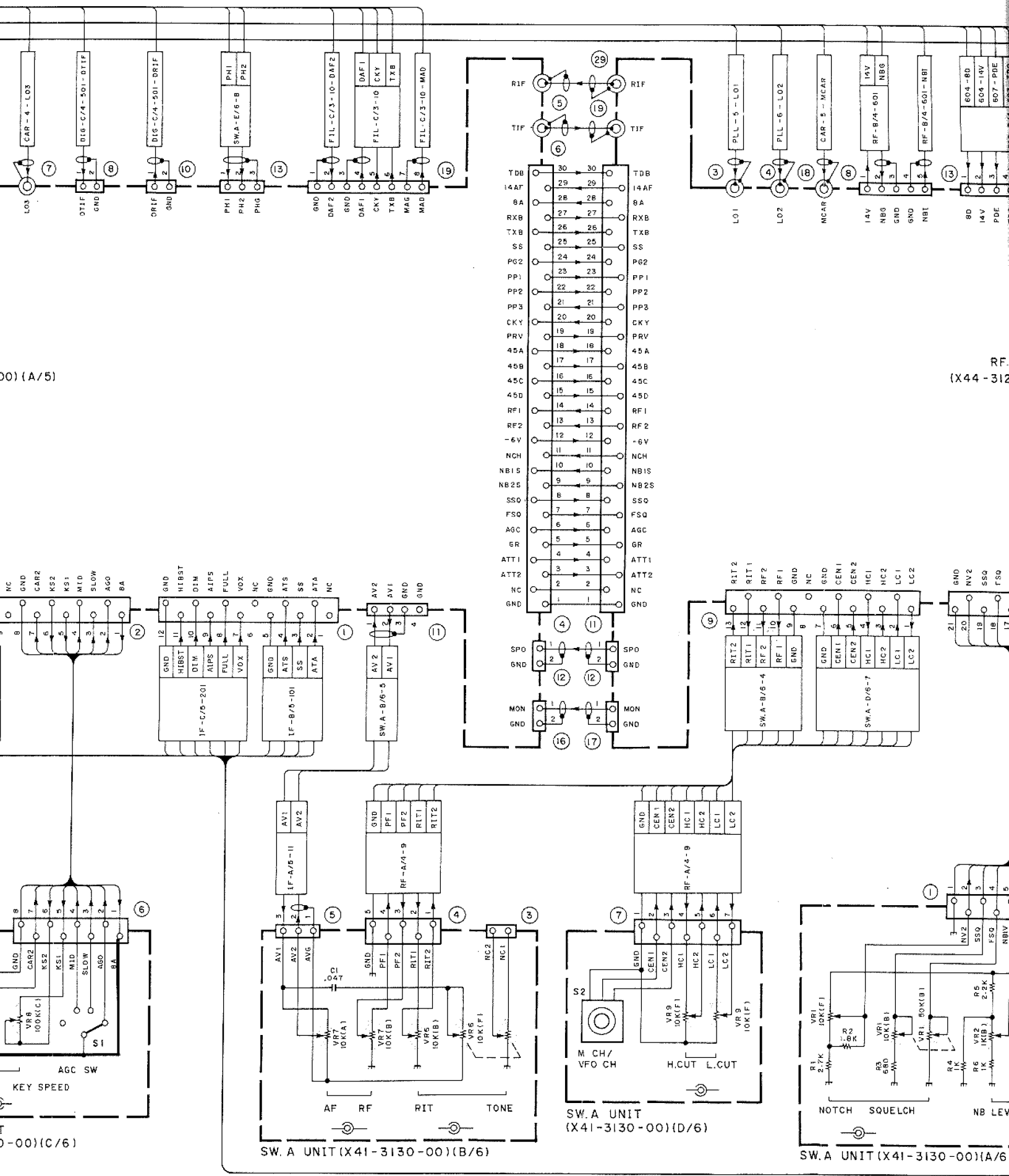

00) (A/5)

RF. (X44-312

00) (C/6)

SW. A UNIT (X41-3130-00) (B/6)

SW. A UNIT (X41-3130-00) (D/6)

SW. A UNIT (X41-3130-00) (A/6)

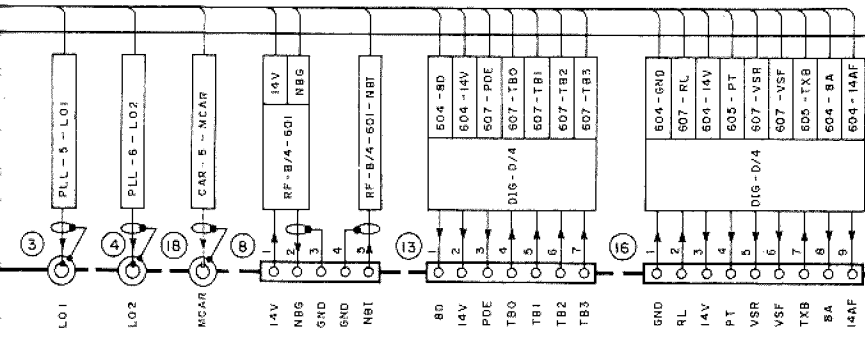

RF UNIT (X44-3120-00) (A/4)

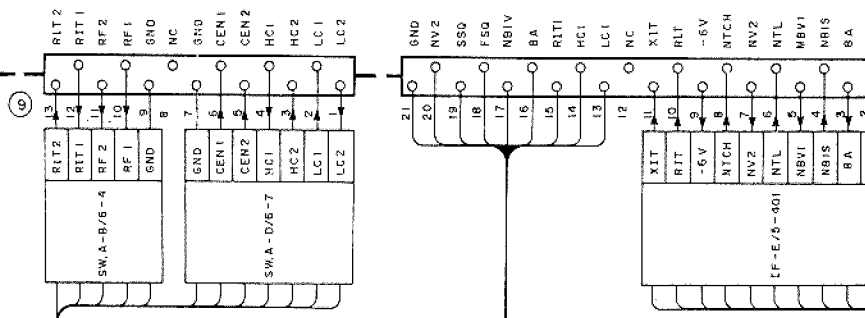

SW.A UNIT (X41-3130-00) (A/6)

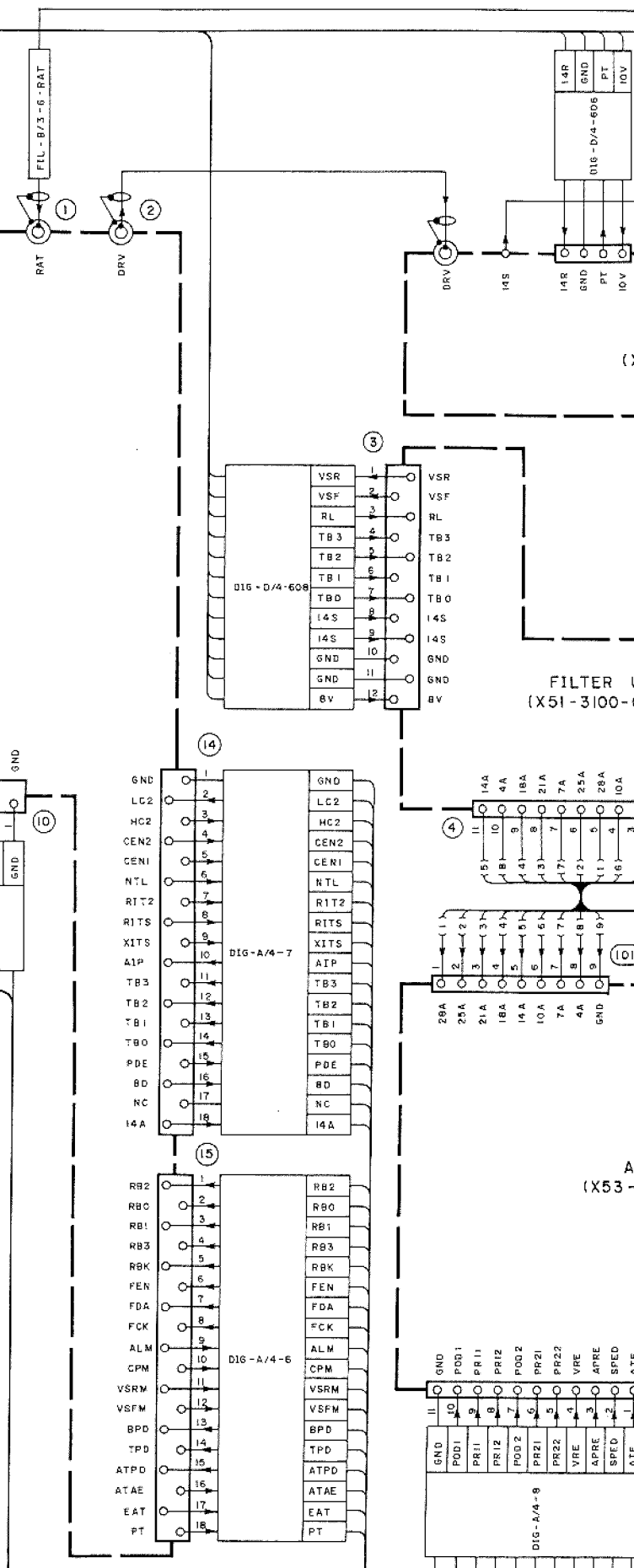
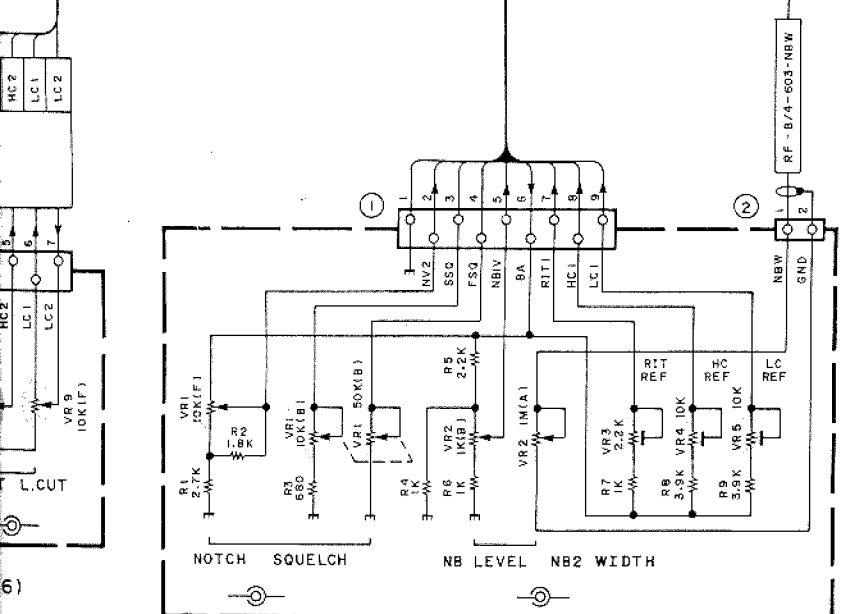

FILTER UNIT (X51-3100-00)

SW.A UNIT (X41-3130-00) (A/6)

SCHEMATIC DIAGRAM TS-850S

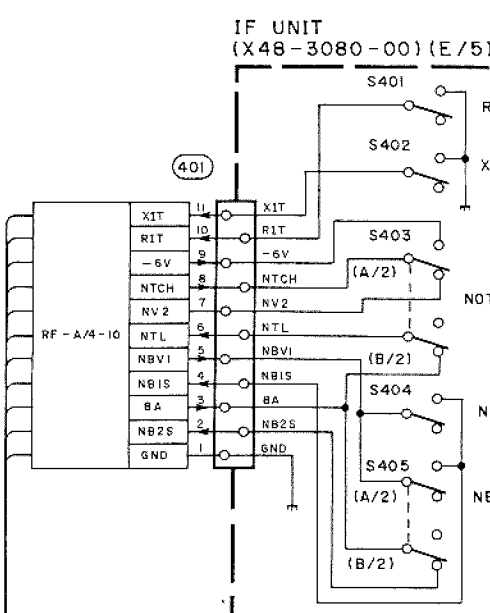
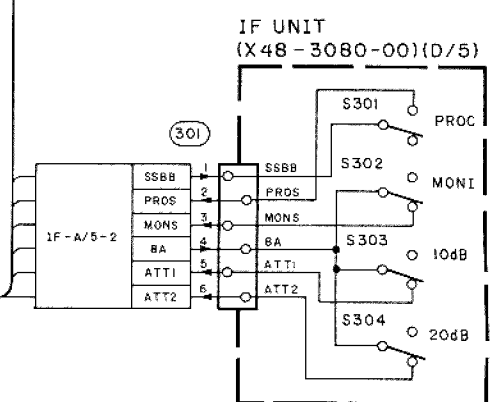
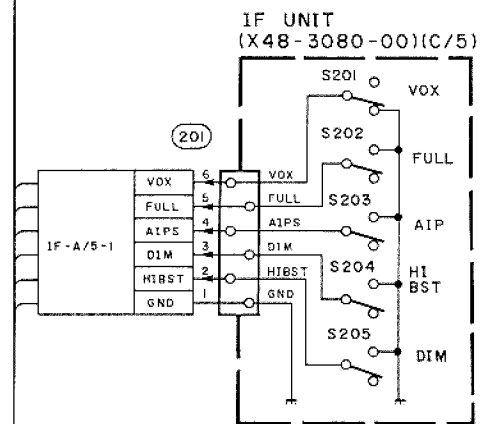
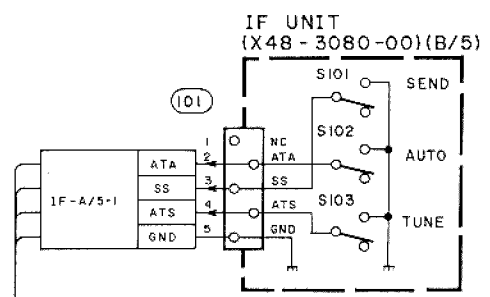
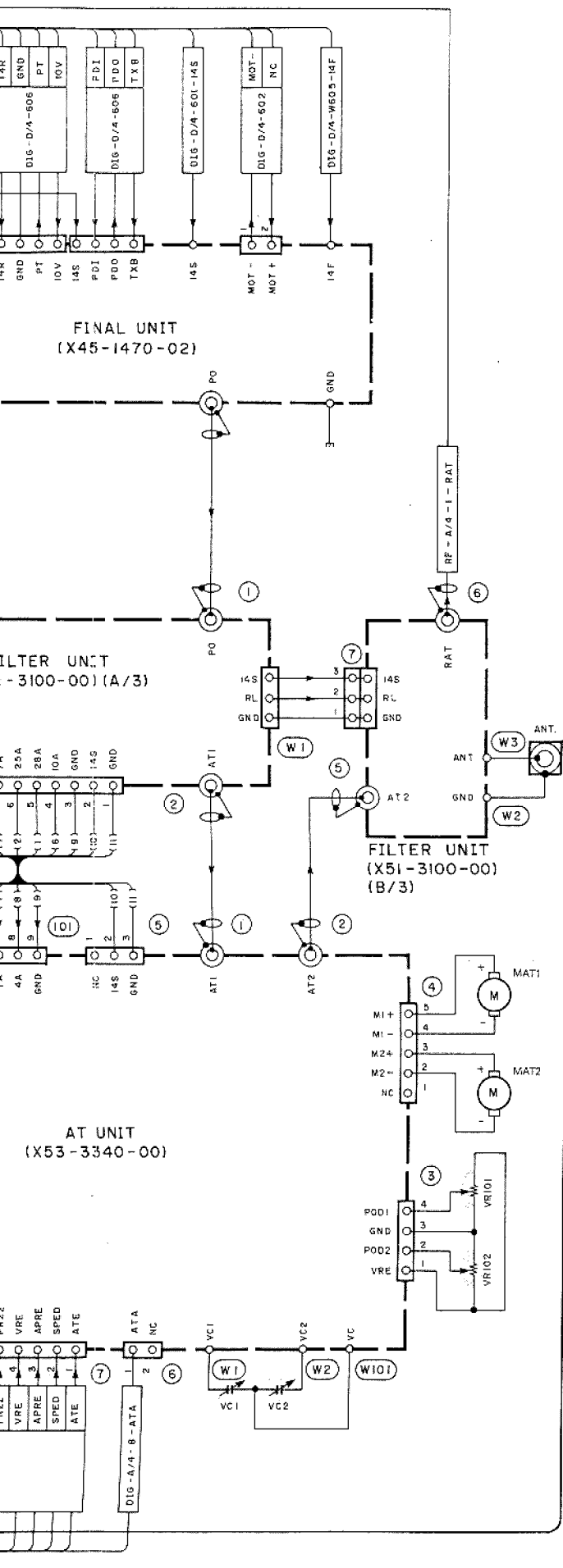

TS-850S TS- BLOCK DIAGRAM

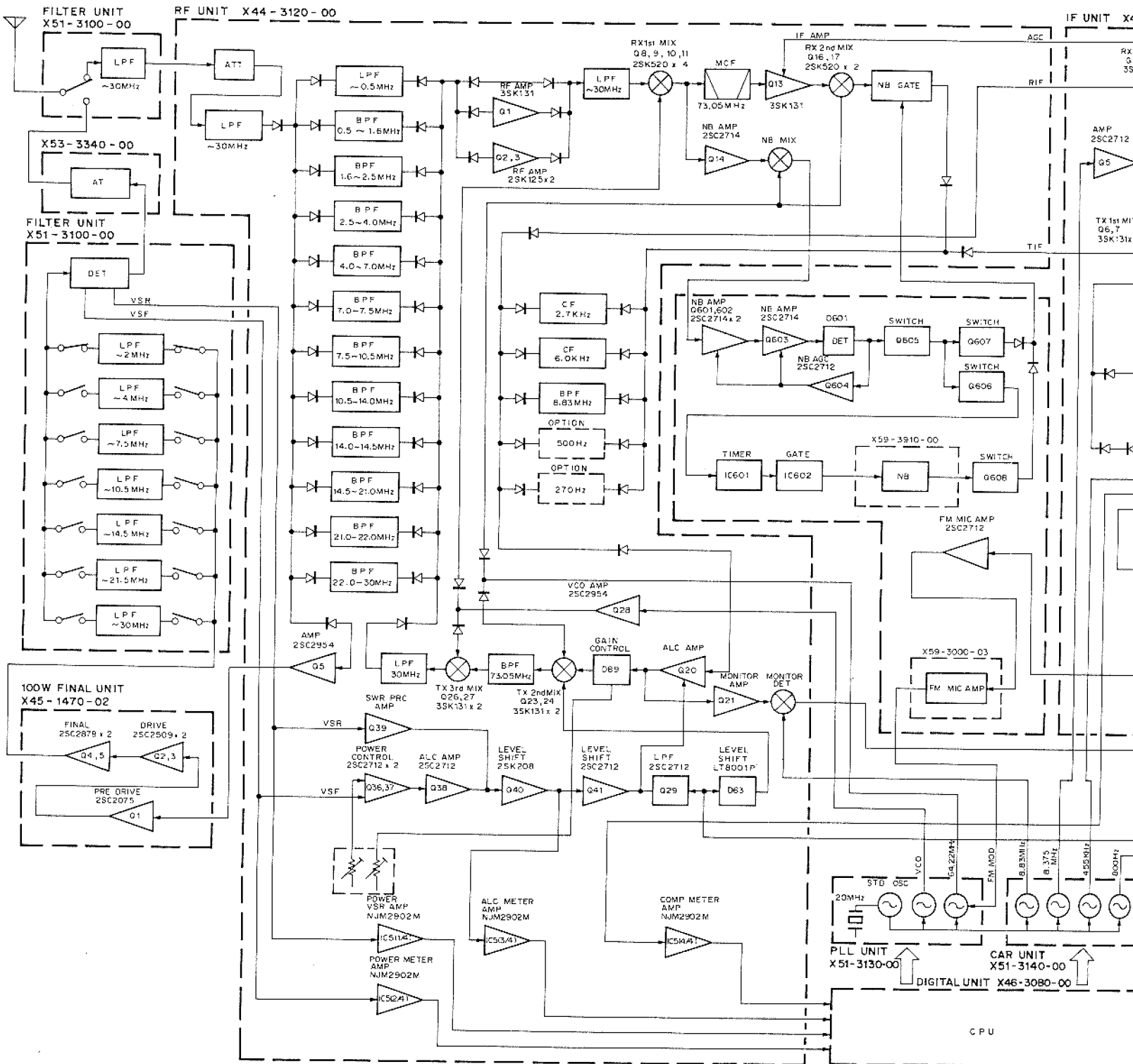

TS-850S

BLOCK DIAGRAM

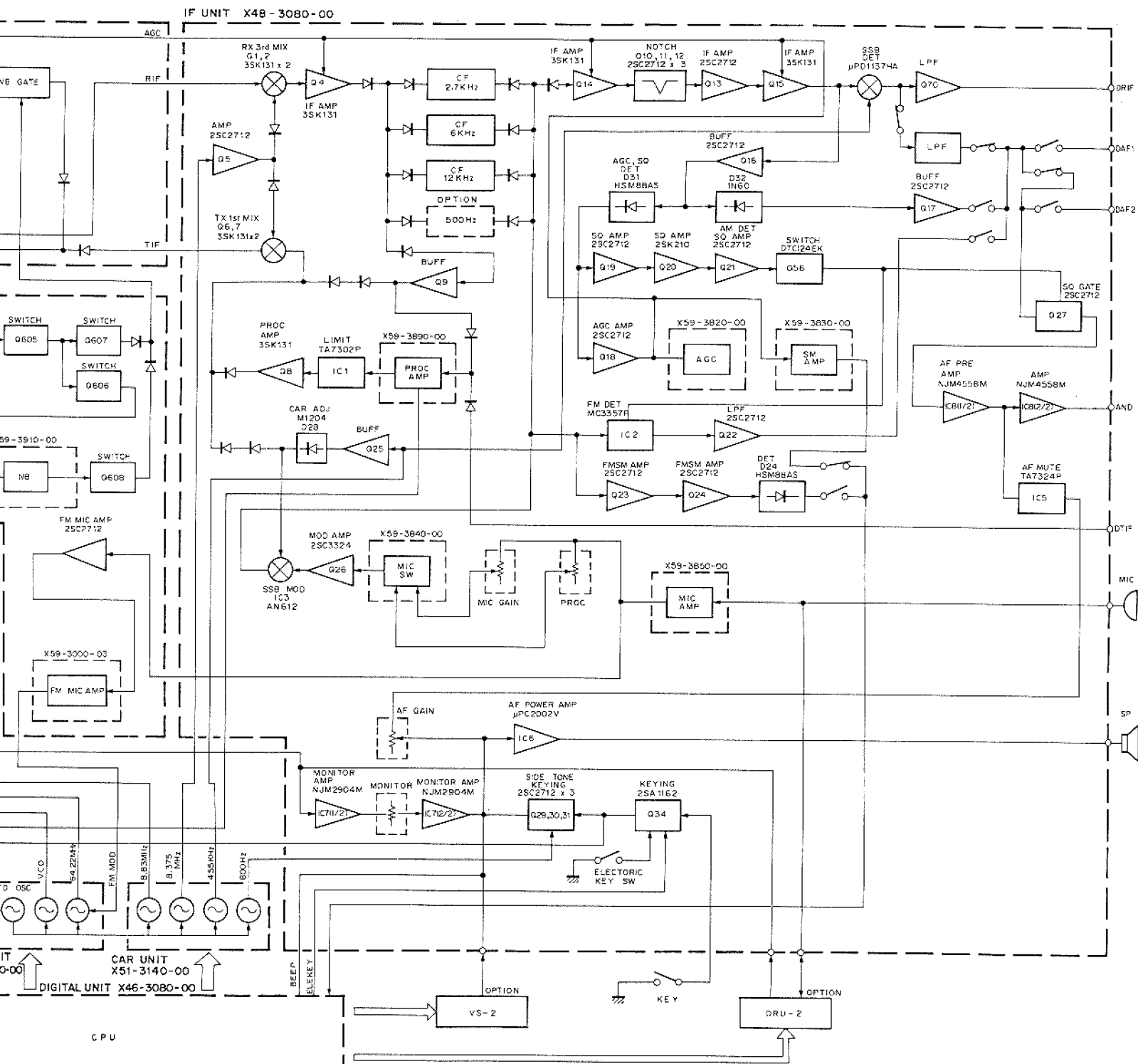

LEVEL DIAGRAM

Receiver Section

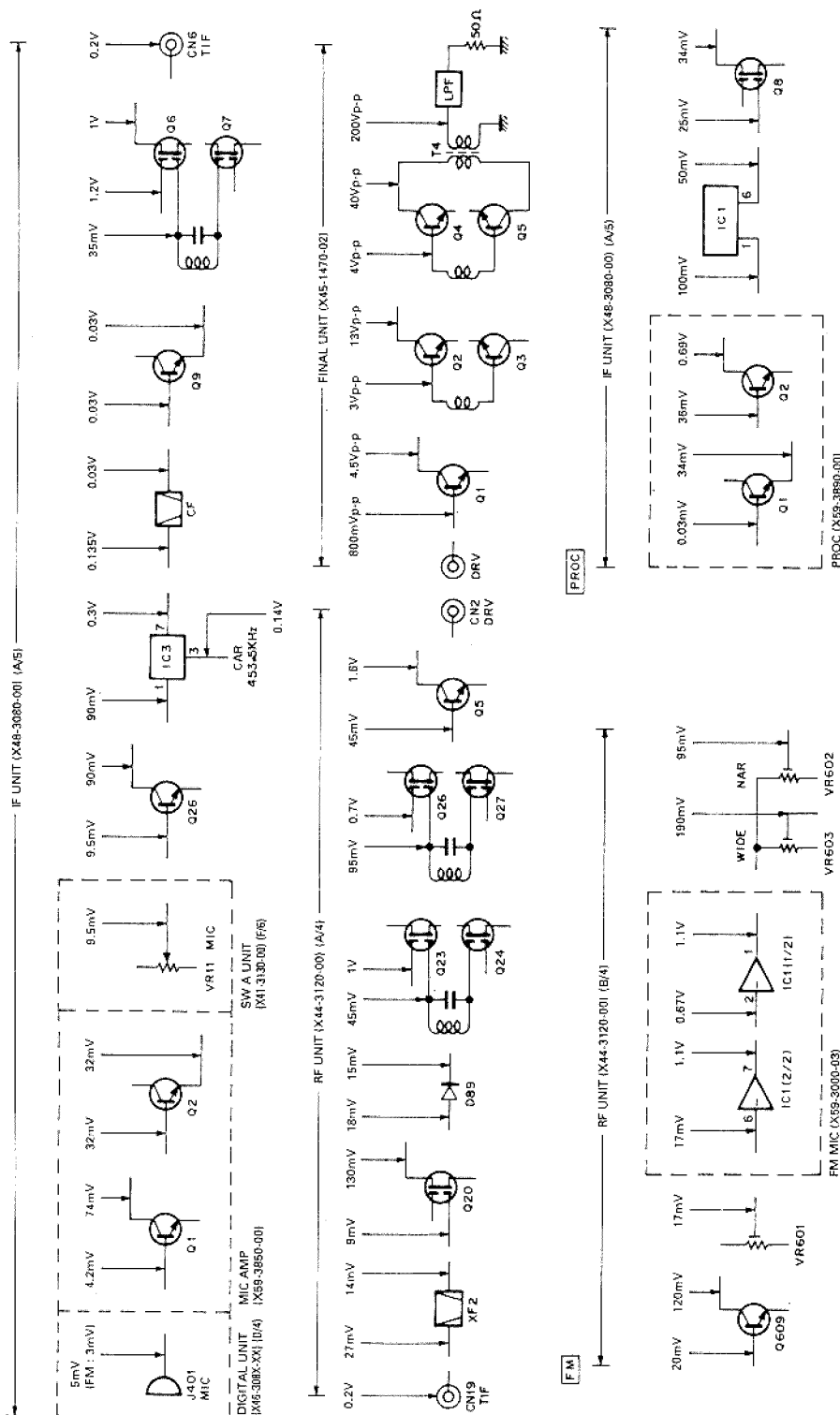

1. Microphone is 5mV, 1kHz input
2. The low-frequency section is measured with an AF variable voltmeter
3. The high-frequency section is measured with an RF variable voltmeter
4. The outputs are all ALC zone maximum
5. FM wide is 3kHz deviation, narrow is 1.5kHz deviation
6. PROC when 20dB COMP

LEVEL DIAGRAM

Transmitter Section

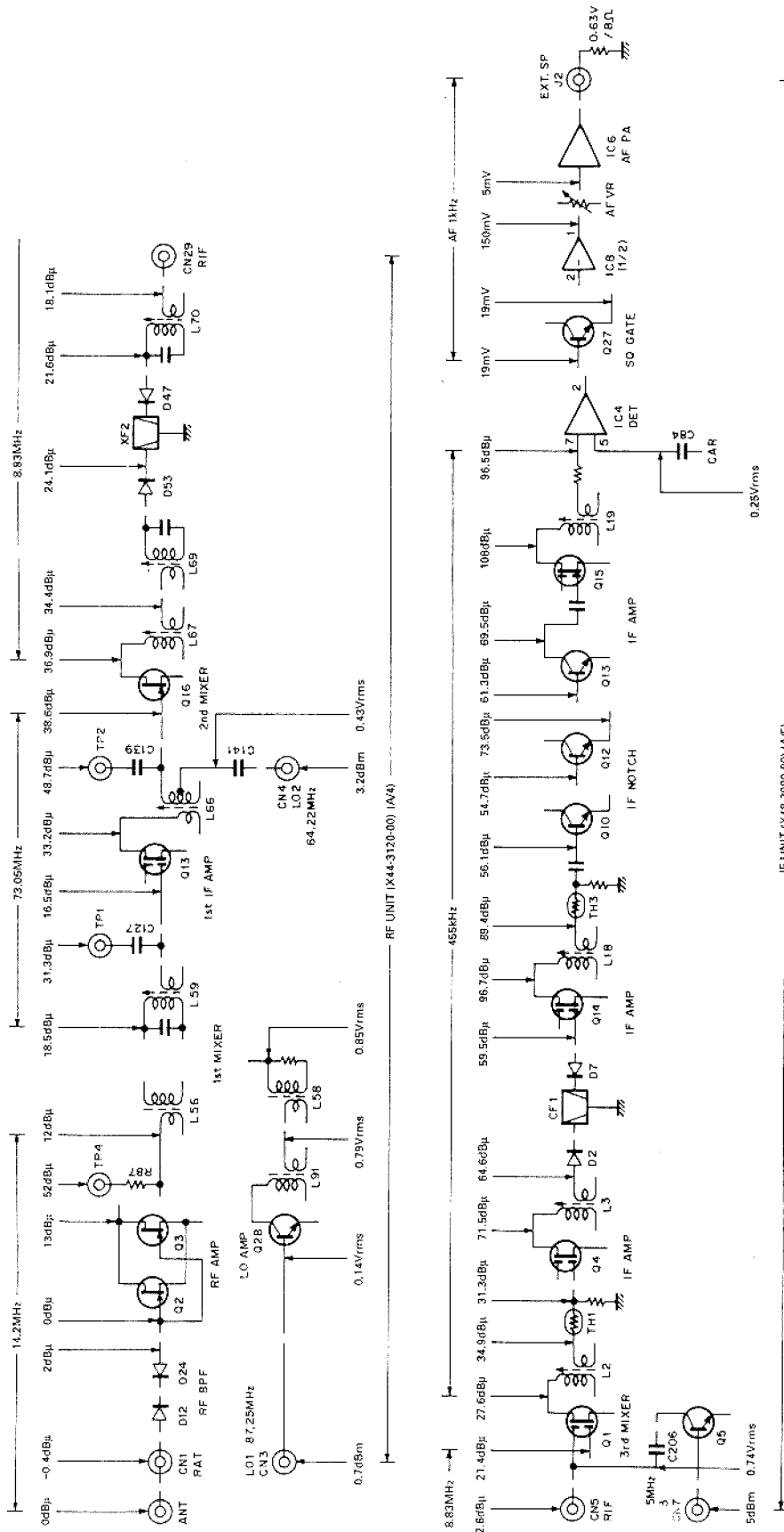

1. Connect the signal generator to the ANT terminal at 14.2MHz USB, apply a signal of 0 dBμ (EMF), tune so that the AF output beat frequency is 1kHz, and adjust the AF VR so that the AF output is 0.63V/8Ω.
2. Connect the signal generator to each measurement point (cut off the DC), and the AF output in (1) so that the above EMFs are obtained. During measurement, the beat frequency of the AF output is normally 1kHz.
3. The signal type connector, TP, shown by ⊙ is measured by removing the coaxial cable inside the set, which is connected to that connector, and connecting the signal generator in its place. The station transmission system connector shown by ⊙ is a value measured by connecting the coaxial cable within the set connected to that connector (input must be 50Ω) to the spectrum analyzer.
4. The AF stage level is the level measured at AF V.M for each stage during the conditions indicated in (1).

- AIP : OFF
 ATT : OFF
 IF FILTER
- 8.83 : 2.7kHz
 455 : 2.7kHz

DRU-2 (DIGITAL RECORDING UNIT)

DRU-2 CIRCUIT DESCRIPTION

1. Overview

The DRU-2 is a digital recording and playback unit designed to be installed inside the TS-850 series.

This unit has the following features:

- Recording received audio (for output to the internal speaker) or transmit audio (microphone input)
- Outputting recorded audio to the internal speaker or outputting recorded audio as modulating signals during transmission
- Built-in lithium battery back-up for maintaining DRU-2 contents

2. Operations

• Recording received audio (for output to the internal speaker)

A received signal from the VO pin is fed into pin 1 (0Y) of the multiplexer IC1 (TC4052BF). It is then fed into pin 59 (MIC IN) of IC3 (TC8830F) via pin 3 (Y). The signal is amplified approx. 26dB by a mic amplifier in IC3, and output via pin 60 (C1). The signal from pin 60 is fed into pin 63 (C2) and amplified approx. 20dB. The amplified signal is applied to pin 64 (MIC OUT) and pin 65 (ADI).

• Recording transmit audio (microphone input)

Microphone input from the VI pin is amplified by Q5, and fed into pin 2 (2Y) of the multiplexer IC1 (TC4052BF). It is then supplied to IC3 (TC8830F) via pin 3 (Y) and recorded in the same way as in recording received sound.

• Outputting recorded audio to the internal speaker

D/A convertor output from pin 66 (DAO) of IC3 (TC8830F) is passed through a CR filter, and amplified by Q6. The amplified signal is then fed into pin 13 (X) of the multiplexer IC1 (TC4052BF), and output to the VO pin via pin 14 (1X).

• Outputting recorded audio as modulating signals during transmission

When sound recorded in the DRU-2 is played during transmission, the same operations as written above in outputting recorded audio to the internal speaker occur. That is, D/A convertor output from pin 66 (DAO) of IC3 (TC8830F) is passed through a CR filter, amplified by Q6, and fed into pin 13 (X) of the multiplexer IC1 (TC4052BF). The sound, however, is output via pin 11 (3X).

	VOA (pin 10)	VOB (pin 9)	On channel
Output to speaker	H	L	1X (pin 14)
Output during transmission	H	H	3X (pin 11)
Received audio recording	L	L	0Y (pin 1)
Transmit audio recording	L	H	2Y (pin 2)

Table 1 IC1 : TC4052BF operations

DRU-2 DESCRIPTION OF COMPONENTS ACCESSORY UNIT (X42-3010-01)

Component	Use/Function	Description
IC1	Multiplexer	See DRU-2 circuit description.
IC3	Audio recording and playback	See DRU-2 semiconductor data.
IC4~7	S-RAM	
Q5	AF amplification	Mic input amplification.
Q6	AF amplification	Playback sound amplification.
D1	Reverse current prevention	
D2	Reverse current prevention	Back-up.

TS-850S

DRU-2 (DIGITAL RECORDING UNIT)

DRU-2 SEMICONDUCTOR DATA

1. Audio recording and playback : TC8830F (IC3)

• Terminal connection diagram

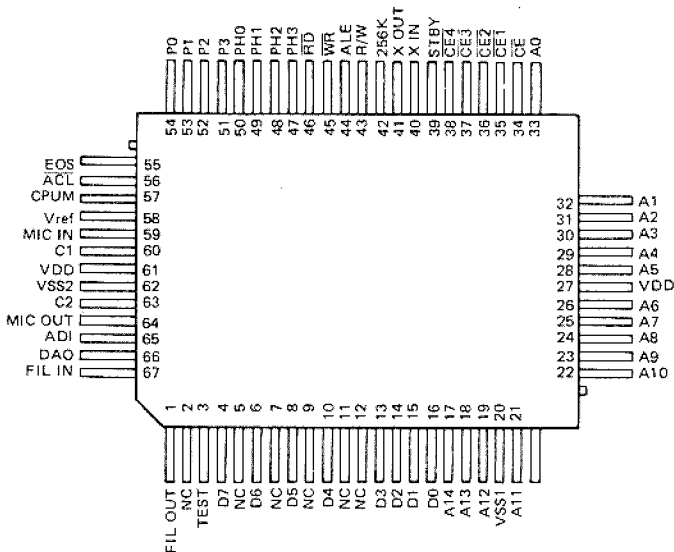

• Block diagram

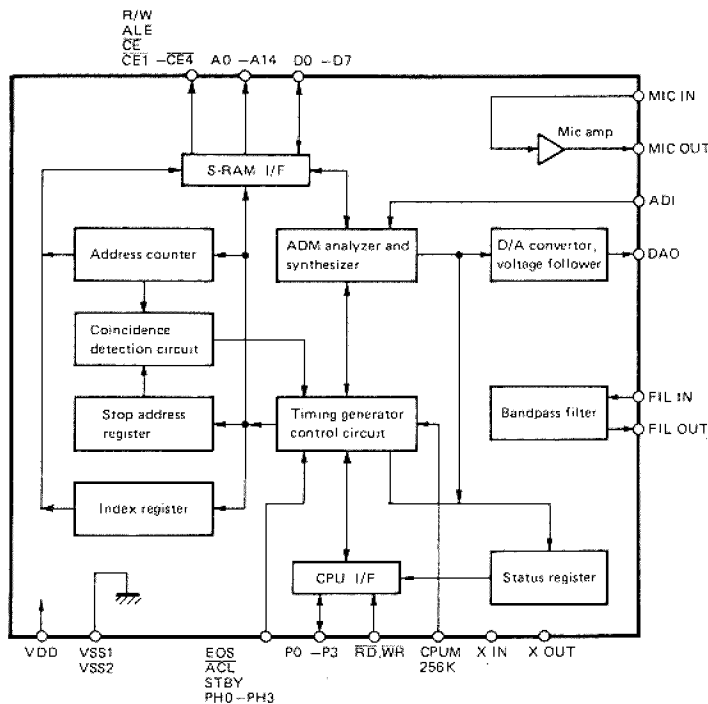

• Terminal functions

Pin No.	Pin name	I/O	Function	Pin No.	Pin name	I/O	Function
1	FIL OUT	O	Not used.	41	X OUT	O	512kHz oscillation circuit.
2	NC	-	Not connected.	42	256K	I	64K/256K RAM select, "H" when 256K used.
3	TEST	-	Not used.	43	R/W	O	RAM read/write output.
4	D7	I/O	RAM data I/O.	44	ALE	-	Not used.
5	NC	-	Not connected.	45	WR	I	Write pulse input.
6	D6	I/O	RAM data I/O.	46	RD	I	Read pulse input.
7	NC	-	Not connected.	47-50	PH3~PH0	-	Not used.
8	D5	I/O	RAM data I/O.	51-54	P3~P0	I/O	Data bus.
9	NC	-	Not connected.	55	EOS	-	Not used.
10	D4	I/O	RAM data I/O.	56	ACL	I	Reset signal input.
11,12	NC	-	Not connected.	57	CPUM	I	"H" when CPU control enabled.
13-16	D3~D0	I/O	RAM data I/O.	58	Vref	O	Analog circuit reference voltage output.
17-19	A14~A12	O	RAM address output.	59	MIC IN	I	Mic amp. 1 input.
20	Vss1	-	GND.	60	C1	O	Mic amp. 1 output.
21-26	A11~A6	O	RAM address output.	61	VDD	-	Power supply.
27	VDD	-	Power supply.	62	Vss2	-	GND.
28-33	A5~A0	O	RAM address output.	63	C2	I	Mic amp. 2 input.
34	CE	-	Not used.	64	MIC OUT	O	Mic amp. 2 output.
35-38	CE1~CE4	O	RAM chip enable.	65	ADI	I	Audio analysis circuit input.
39	STBY	I	Minimum current standby when standby input is "H".	66	DAO	O	D/A converter output.
40	X IN	I	512kHz oscillation circuit.	67	FIL IN	I	Not used.

DRU-2 (DIGITAL RECORDING UNIT)

× New Parts

Parts without Parts No. are not supplied.

Les articles non mentionnés dans le Parts No. ne sont pas fournis.

Teile ohne Parts No. werden nicht geliefert.

DRU-2 PARTS LIST

Ref. No. 参照番号	Address 位置	New Parts 新	Parts No. 部品番号	Description 部品名 / 規格	Desti- nation 仕向	Re- marks 備考
DRU-2						
		*	B42-3317-04 B62-0145-00	LABEL INSTRUCTION MANUAL		
			G10-0666-04 G10-0679-04 G13-0913-04	NON-WOVEN FABRIC NON-WOVEN FABRIC FORMED PLATE		
			H21-0704-04 H25-0029-04 H25-0710-04	PROTECTION SHEET PROTECTION BAG PROTECTION BAG		
		*	H52-0156-03	ITEM CARTON BOX		
		*	H62-0135-04	OUTER PACKING CASE		
			N87-2606-46	BRAZIER HEAD TAPTITE SCREW		
		*	X42-3010-01	ACCESSORY UNIT		
ACCESSORY UNIT (X42-3010-01)						
C1			CK73FB1H103K	CHIP C 0.010UF K		
C2			CK73FB1H102K	CHIP C 1000PF K		
C3			CK73FF1E154Z	CHIP C 0.15UF Z		
C4 -6			CK73FB1H103K	CHIP C 0.010UF K		
C7			CK73EF1C105Z	CHIP C 1.0UF Z		
C8 -10			CK73FB1H103K	CHIP C 0.010UF K		
C11			CK73FF1E104Z	CHIP C 0.1UF Z		
C15			CK73FF1E104Z	CHIP C 0.1UF Z		
C17			CK73FF1E104Z	CHIP C 0.1UF Z		
C19			CK73FB1H103K	CHIP C 0.010UF K		
C20			CK73FB1H102K	CHIP C 1000PF K		
C21 ,22			CC73FSL1H101J	CHIP C 100PF J		
C23			CK73FB1H103K	CHIP C 0.010UF K		
C24			C92-0010-05	CHIP TAN 6.8UF 6.3WV		
C25			CK73EB1H104K	CHIP C 0.10UF K		
C26			CK73FB1H103K	CHIP C 0.010UF K		
C27			CC73FSL1H101J	CHIP C 100PF J		
C28			CK73EB1H104K	CHIP C 0.1UF K		
CN1			E40-5207-05	PIN CONNECTOR		
CN2			E40-5206-05	PIN CONNECTOR		
CN3			E40-5181-05	PIN CONNECTOR		
W1			E31-6005-05	CONNECTING WIRE		
W2			E31-6006-05	CONNECTING WIRE		
W3			E31-6007-05	CONNECTING WIRE		
			F20-0520-04 F20-0521-04	INSULATING BOARD INSULATING BOARD		
X1			L77-1398-05	CRYSTAL RESONATOR 3.579545MHZ		
X2			L78-0050-05	RESONATOR 512KHZ		
R1			RK73FB2A103J	CHIP R 10K J 1/10W		
R2			RK73FB2A392J	CHIP R 3.9K J 1/10W		
R3			RK73FB2A103J	CHIP R 10K J 1/10W		
R4			RK73FB2A105J	CHIP R 1.0M J 1/10W		
R5			RK73FB2A102J	CHIP R 1.0K J 1/10W		
R6			R92-0670-05	CHIP R 0 OHM		
R7			RK73FB2A223J	CHIP R 22K J 1/10W		
R8			RK73FB2A102J	CHIP R 1.0K J 1/10W		

E: Scandinavia & Europe K: USA P: Canada W: Europe

U: PX(Far East, Hawaii) T: England M: Other Areas

UE: AAFES(Europe) X: Australia

⚠ indicates safety critical components.

DRU-2 (DIGITAL RECORDING UNIT)

× New Parts

Parts without Parts No. are not supplied.

Les articles non mentionnés dans le Parts No. ne sont pas fournis.

Teile ohne Parts No. werden nicht geliefert.

Ref. No. 参照番号	Address 位置	New Parts 新	Parts No. 部品番号	Description 部品名 / 規格	Desti- nation 仕 向	Re- marks 備考
R9			RK73FB2A105J	CHIP R 1.0M J 1/10W		
R10			R92-0670-05	CHIP R 0 ΩHM		
R11			RK73FB2A223J	CHIP R 22K J 1/10W		
R12 ,13			RK73FB2A222J	CHIP R 2.2K J 1/10W		
R14			RK73FB2A472J	CHIP R 4.7K J 1/10W		
R18			RK73FB2A105J	CHIP R 1.0M J 1/10W		
R19			RK73FB2A562J	CHIP R 5.6K J 1/10W		
R20			RK73FB2A104J	CHIP R 100K J 1/10W		
R21			RK73FB2A103J	CHIP R 10K J 1/10W		
R22			RK73FB2A102J	CHIP R 1.0K J 1/10W		
R23			RK73FB2A564J	CHIP R 560K J 1/10W		
R24			RK73FB2A683J	CHIP R 68K J 1/10W		
R25			RK73FB2A223J	CHIP R 22K J 1/10W		
R26			RK73FB2A105J	CHIP R 1.0M J 1/10W		
R27			RK73FB2A222J	CHIP R 2.2K J 1/10W		
R28			RK73FB2A224J	CHIP R 220K J 1/10W		
R29 -31			R92-0670-05	CHIP R 0 ΩHM		
R32			RK73FB2A220J	CHIP R 22 J 1/10W		
R33			RK73FB2A394J	CHIP R 390K J 1/10W		
D1 ,2			1SS184	DIODE		
IC1			TC4052BF	IC		
IC2			LR4102N	IC		
IC3			TC8830F	IC		
IC4 -7			HM62256LFP1-12T	IC		
IC4 -7			HM62256LFP-15T	IC		
Q1 ,2			2SC2712(BL)	TRANSISTOR		
Q5 -6			2SC2712(BL)	TRANSISTOR		
			WD9-0326-05	LITHIUM BATTERY		

E: Scandinavia & Europe K: USA P: Canada W: Europe

U: PX(Far East, Hawaii) T: England M: Other Areas

UE: AAFES(Europe) X: Australia

△ indicates safety critical components.

DRU-2 PC BOARD VIEWS

ACCESSORY UNIT (X42-3010-01) Component side view

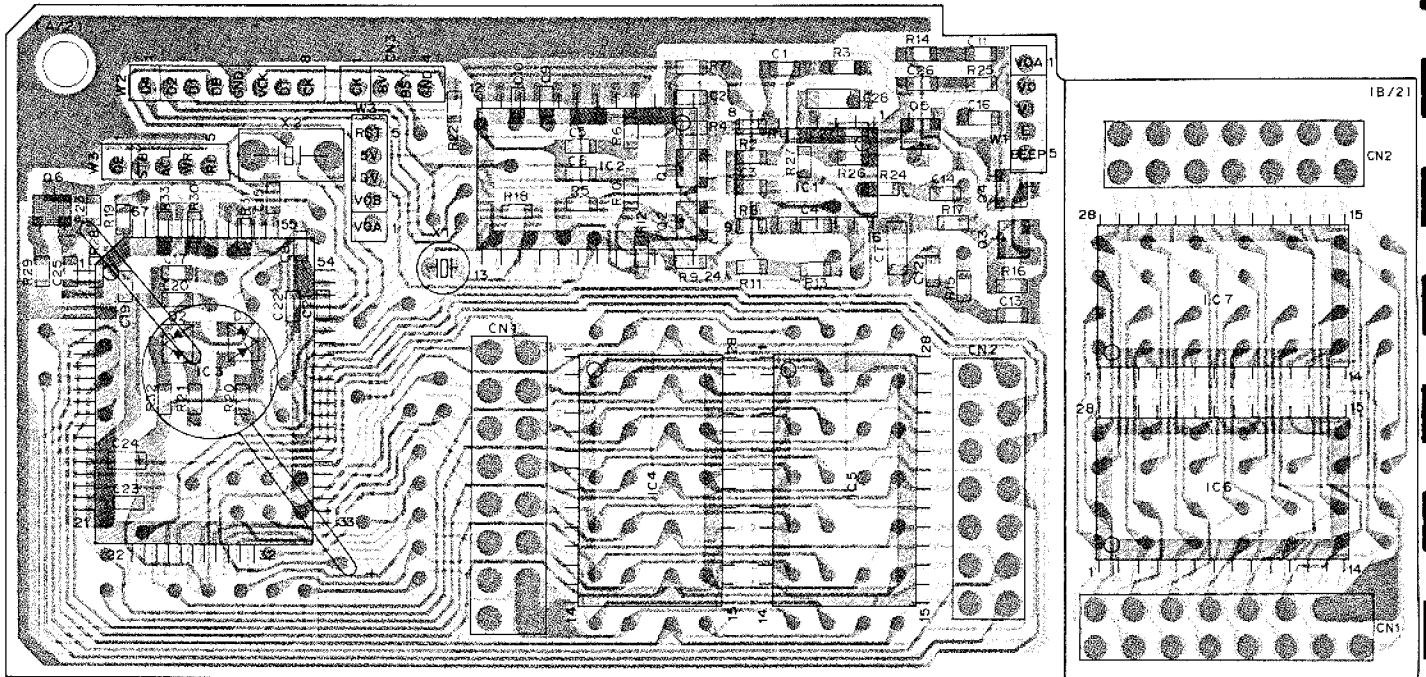

IC1 : TC4052BF IC2 : LR4102N IC3 : TC8830F IC4-7 : HM62256LFPI-12T Q1,2,5,6 : 2SC2712(BL) D1,2 : 1SS184

ACCESSORY UNIT (X42-3010-01) Foil side view

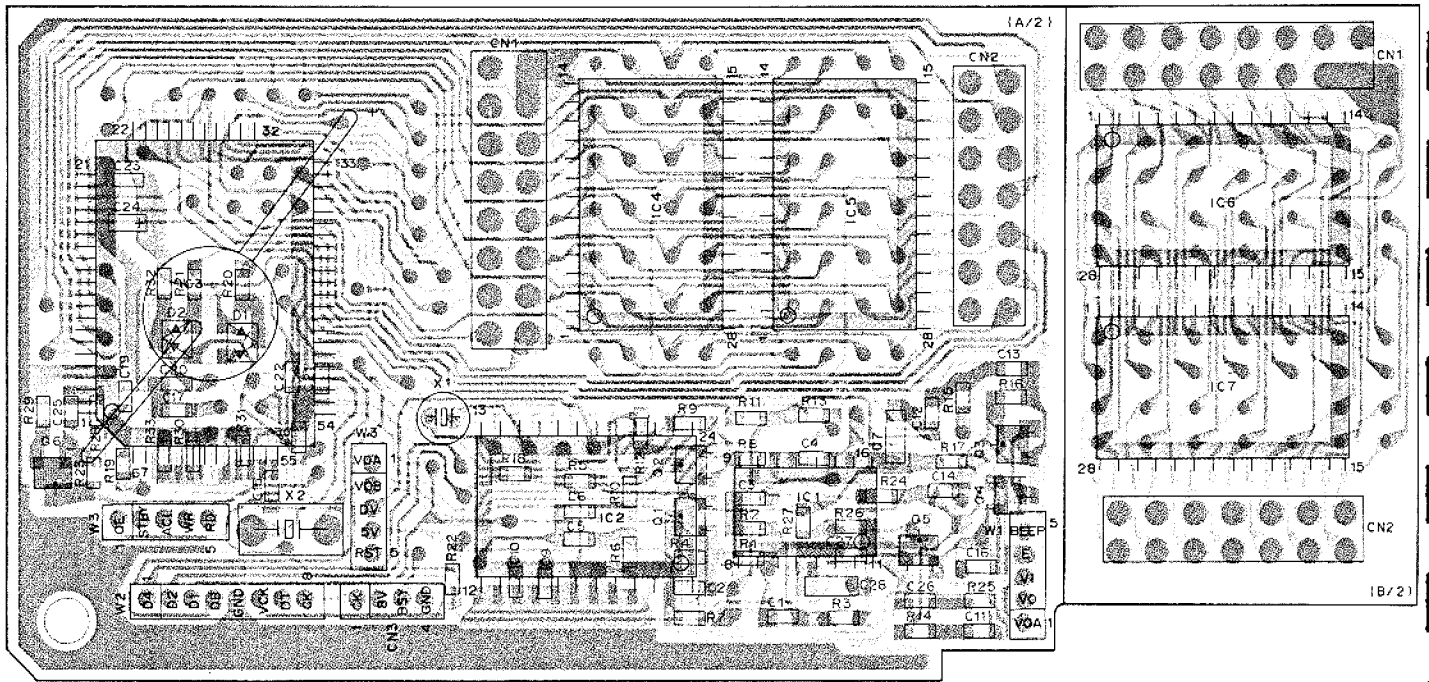

2SC2712(BL)

HM62256LFPI-12T

TC4052BF

LR4102N

TC8830F

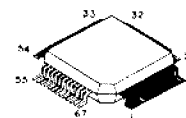
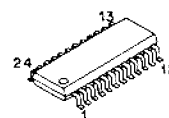
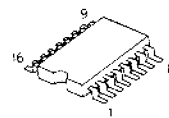
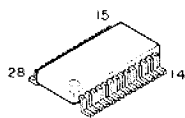
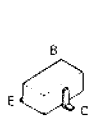

DRU-2 SCHEMATIC DIAGRAM

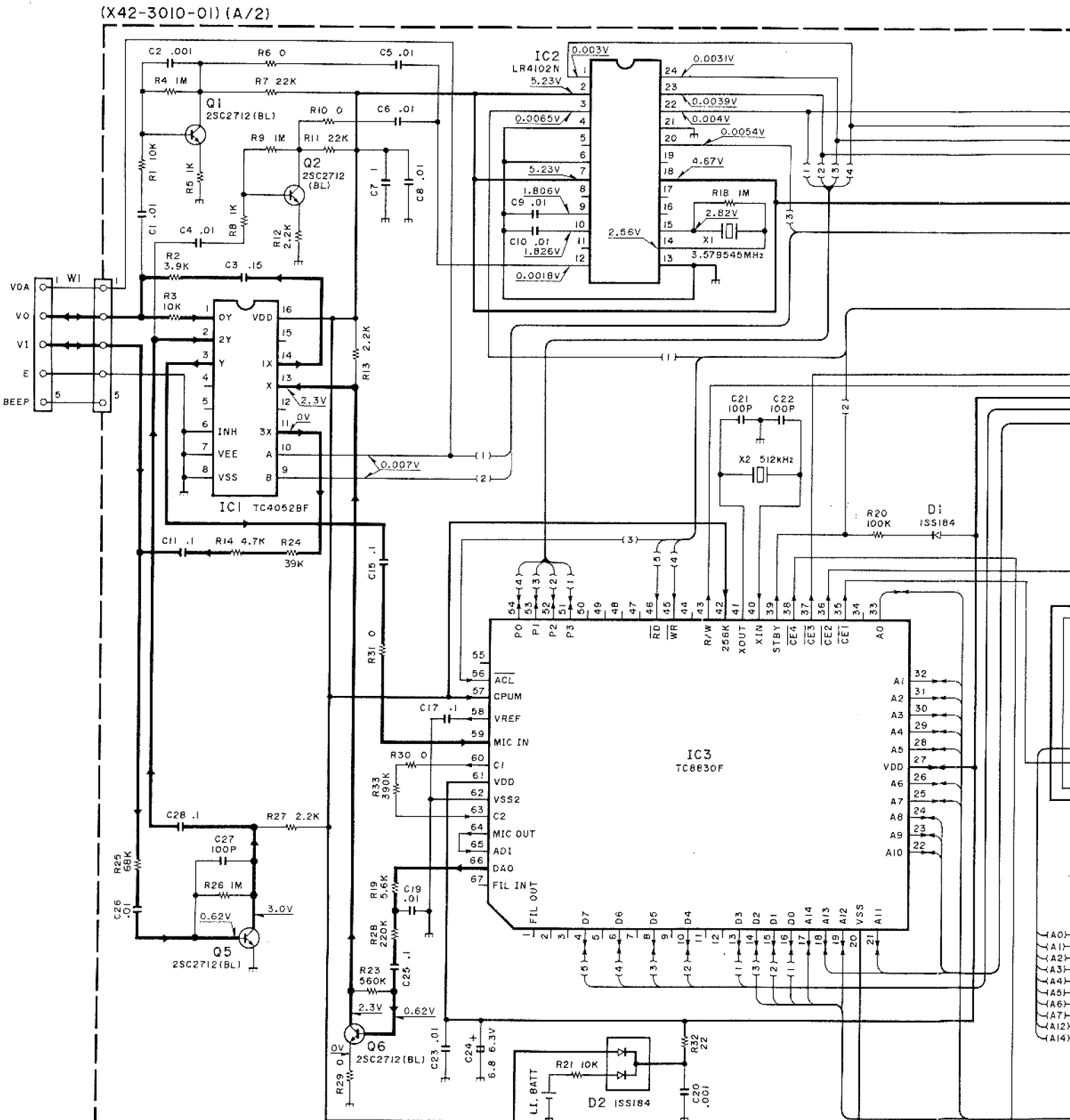

DRU-2 (DIGITAL RECORDING UNIT) TS-850S

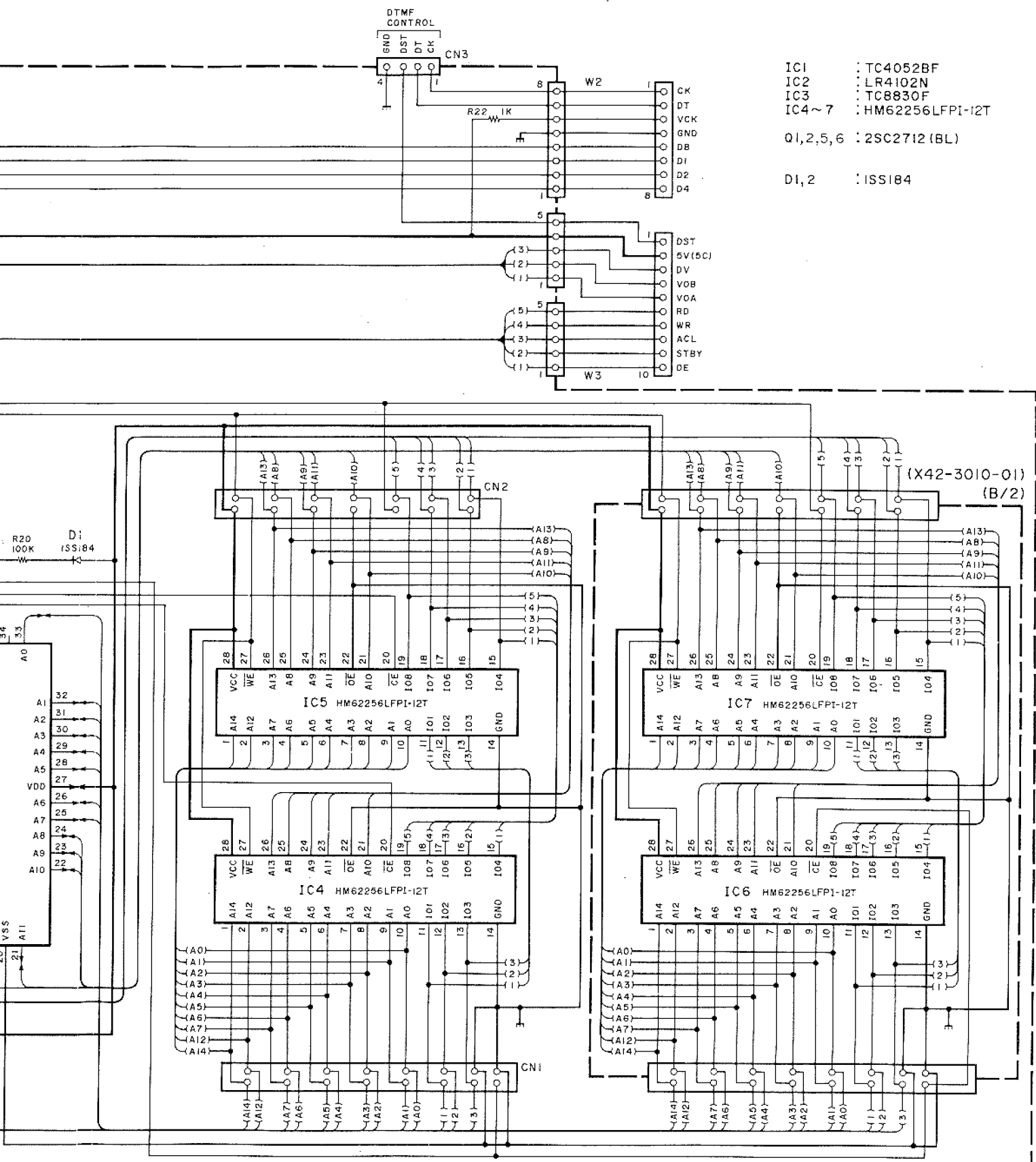

- IC1 : TC4052BF
- IC2 : LR4102N
- IC3 : TC8830F
- IC4~7 : HM62256LFPI-12T
- Q1,2,5,6 : 2SC2712 (BL)
- D1,2 : ISS184

TS-850S

PS-52 (DC POWER SUPPLY)

PS-52 SPECIFICATIONS

VERSIONS	PS-52		
	U.S.A.	Europe and General markets	U.K. and Oceania
Power requirements	120 VAC \pm 10%, 60 Hz	* 120/220-240 VAC \pm 10%, 50/60 Hz	240 VAC \pm 10%, 50/60 Hz
Output voltage	13.8 VDC (Reference)		
Rated output current	22.5A (25% duty cycle) 16A (50% duty cycle)		
Output voltage regulation	Within \pm 0.7 V (at 120/220-240 VAC \pm 10% variation with 22.5A) Within \pm 0.7 V (at load current variation from 2 to 22.5A)		
Ripple voltage	Less than 20 mVrms (at 13.8 VDC/ 22.5A)		
Power consumption	Approx. 500 W (at 13.8 VDC/20A)		
Dimensions (W x H x D) Dimensions in [] include projections.	180 x 120 x 310 mm [183 x 134 x 343 mm] 6-27/32" x 4-23/32" x 12-7/32" [7-7/32" x 5-9/32" x 13-1/2"]		
Weight	Approx. 7.9 kg (17.4 lbs)		

NOTES:

1. Rating are subject to change without notice due to advancements in technology.
2. *: Switchable. AC voltage is preset to 220-240 VAC at the factory.

PS-52 ADJUSTMENT

1. POWER : OFF
2. Connect the 0.1 Ω 10W resistor to output terminal.
3. POWER switch is turned on, then adjust obtain the proper 0.1V voltage by VR2.

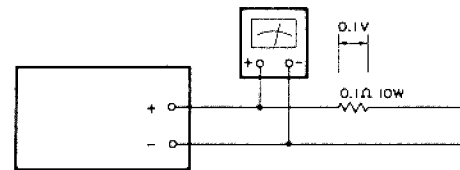

PS-52 PACKING

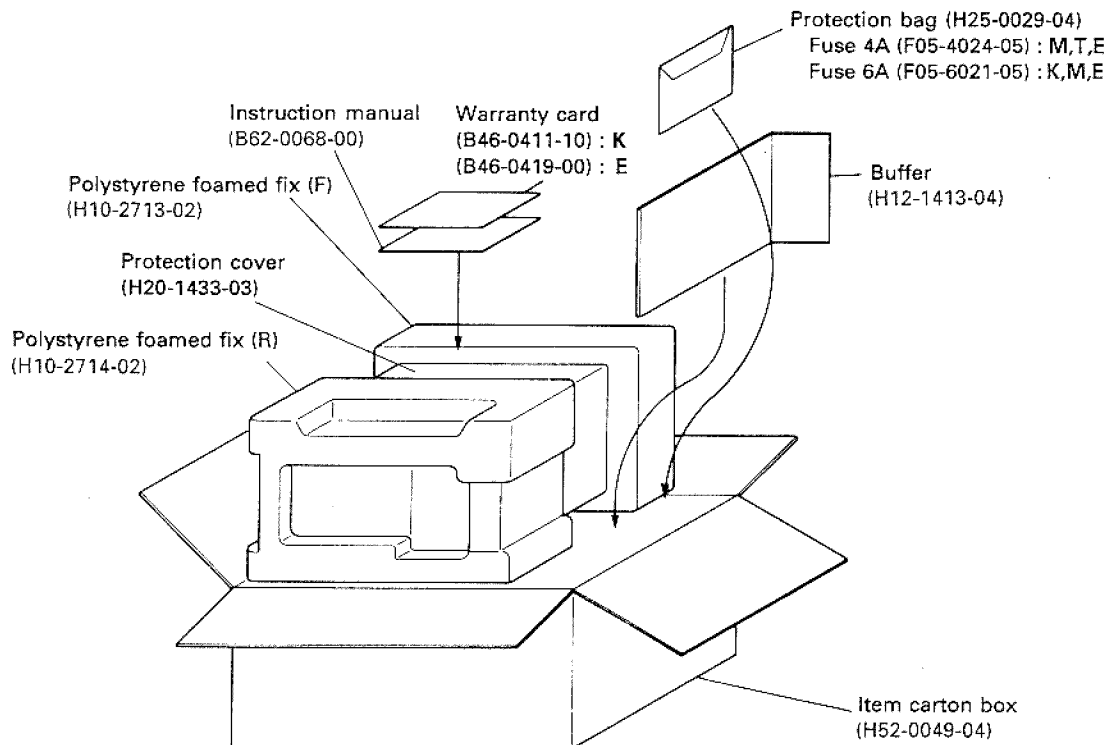

PS-52 (DC POWER SUPPLY)

× New Parts

Parts without Parts No. are not supplied.

Les articles non mentionnés dans le Parts No. ne sont pas fournis.

Teile ohne Parts No. werden nicht geliefert.

Ref. No. 参照番号	Address 位置	New Parts 新	Parts No. 部品番号	Description 部品名 / 規格	Desti- nation 仕 向	Re- marks 備考
PS-52						
		*	A01-2016-02	CASE(UPPER)		
		*	A01-2017-02	CASE(LOWER)		K, T
		*	A01-2018-02	CASE(LOWER)		M, E
			A23-1505-03	REAR PANEL		T, E
		*	A23-1506-03	REAR PANEL		M
			A23-1510-03	REAR PANEL		K
			A62-0047-03	PANEL ASSY		
			B41-0659-14	CAUTION LABEL		K
			B41-0660-04	CAUTION LABEL		K
			B42-2454-04	SERIAL LABEL		
			B42-3343-04	SERIAL LABEL		
			B42-3346-04	SPEC. LABEL(FUSE)		K
			B42-3355-04	SPEC. LABEL(EARTH)		T, E
			B42-3374-04	SPEC. LABEL		M
		*	B42-3449-04	LABEL		E
			B42-3454-04	LABEL(FUSE, F1)		M, E, T
			B46-0411-10	WARRANTY CARD		K
			B46-0419-00	WARRANTY CARD		E
		*	B62-0068-00	INSTRUCTION MANUAL		
		*	B72-0084-04	MODEL NAME PLATE		K
		*	B72-0085-04	MODEL NAME PLATE		M, E
		*	B72-0086-04	MODEL NAME PLATE		T
C1	-4		CK45F1H103Z	CERAMIC 0.010UF Z		
C5			C90-2085-05	ELECTRO 47000UF 25WV		
C6			CK45F1H473Z	CERAMIC 0.047UF Z		
			E20-0284-05	TERMINAL BOARD		
		*	E30-0585-25	AC POWER CORD		E
			E30-0602-05	AC POWER CORD CORD		T
			E30-2120-05	AC POWER CORD CORD		K, M
			E31-3373-15	LEAD WITH TERMINAL		
			E31-3374-05	LEAD WISH TERMINAL		
			E31-3375-05	LEAD WISH TERMINAL		
			E31-3377-05	LEAD WISH CONNECTOR		
			E31-3379-05	LEAD WISH CONNECTOR		
			E31-3454-05	LEAD WISH TERMINAL		
			F01-0962-13	HEAT SINK		
			F05-4024-05	FUSE(4A)		M, T, E
			F05-6021-05	FUSE(6A) ACSY		M, E
			F09-0421-05	FUSE(6A)		K
MI			F09-0423-15	FAN		
			F20-1005-04	INSULATING BOARD		
			F29-0436-04	INSULATING BUSH(Q1,2)		
		*	H10-2713-02	POLYSTYRENE FOAMED FIXTURE(F)		
		*	H10-2714-02	POLYSTYRENE FOAMED FIXTURE(R)		
			H12-1413-04	BUFFER		
			H20-1433-03	PROTECTION COVER		
			H25-0029-04	PROTECTION BAG(FUSE)		
			H25-0105-04	PROTECTION BAG(AC POW. CORD)		
		*	H52-0049-04	ITEM CARTON BOX		
			J02-0049-14	FOOT(REAR)		
			J02-0423-04	FOOT(FRONT OUTSIDE)		

E: Scandinavia & Europe K: USA P: Canada W: Europe

U: PX(Far East, Hawaii) T: England M: Other Areas

UE: AAFES(Europe) X: Australia

⚠ indicates safety critical components.

PS-52 (DC POWER SUPPLY)

× New Parts

Parts without Parts No. are not supplied.

Les articles non mentionnés dans le Parts No. ne sont pas fournis.

Teile ohne Parts No. werden nicht geliefert.

Ref. No. 参照番号	Address 位置	New Parts 新	Parts No. 部品番号	Description 部品名 / 規格	Desti- nation 仕 向	Re- marks 備考					
T1 T1 T1		*	J02-0424-04	FOOT(FRONT INSIDE)	K						
			J13-0033-15	FUSE HOLDER							
			J19-0306-05	CORD HOLDER(PANEL)							
			J21-4179-04	MOUNTING HARDWARE(ELECTRO)							
			J21-4328-03	MOUNTING HARDWARE(FAN)							
			*	J42-0024-15			CORD BUSHING	K, M T, E			
				J42-0085-05			CORD BUSHING				
				J61-0307-05			WIRE BAND				
				K29-4636-04			PUSH KNOB(POWER)				
				*			L01-8462-05		POWER TRANSFORMER(240V)	T K M, E	
							L01-8471-05		POWER TRANSFORMER(120V)		
			L01-8475-05				POWER TRANSFORMER(120/230V)				
			S1 S2					N09-0372-04	SCREW(PULLEY)	T, E	
								N09-0754-05	SCREW		
								N09-2033-04	BIND HEAD SCREW(TRANSISTOR)		
N09-2050-05	ROUND HEAD SCREW(EARTH)										
N14-0535-04	HEX. NUT(TRANSISTOR)										
N16-0040-46	SPRING WASHER(DIODE)										
	N19-0642-04				FLAT WASHER(TRANSISTOR)						
	N30-3004-46				ROUND HEAD SCREW(MOTOR MOUNT.)						
	N30-4018-46				ROUND HEAD SCREW(DIODE)						
	N33-3008-41				FLAT HEAD SCREW						
N50-3008-41	BINDING HEAD TAPPING SCREW	M, E									
	N87-3006-46		BRAZIER HEAD TAPTITE SCREW								
	N87-3014-46		BRAZIER HEAD TAPTITE SCREW								
	N87-4008-45		BRAZIER HEAD TAPTITE SCREW								
	N87-4008-46		BRAZIER HEAD TAPTITE SCREW								
S1 S2			N88-3008-46	FLAT HEAD TAPTITE SCREW(POW SW)	M, E						
			S40-1416-05	PUSH SWITCH(POWER)							
Q1 Q2 Q1 ,2			S31-2126-05	SLIDE SWITCH(VOLTAGE SEL.)	M, E						
			S25VB10	DIODE							
			TLR205	LED							
Q1 ,2			2N5885	TRANSISTOR							
			* X43-3030-01	POWER SUPPLY UNIT							
POWER SUPPLY UNIT (X43-3030-01)											
C1 -3 C4 C5 C6 C7			CK45F1H103Z	CERAMIC 0.010UF Z							
			CK45F1H473Z	CERAMIC 0.047UF Z							
			CE04EW1C331M	ELECTRO 330UF 16WV							
			CE04EW1A470M	ELECTRO 47UF 10WV							
			CK45F1H103Z	CERAMIC 0.010UF Z							
			C8 C9 -11 C12 C13 C14					CK45F1H473Z	CERAMIC 0.047UF Z		
								C90-0814-05	ELECTRO 4700UF 25WV		
CW92M1H104K	MYLAR 0.10UF K										
C15 ,16			CK45B1H102K	CERAMIC 1000PF K							
			C91-0647-05	CERAMIC 0.01UF P							
CN1 ,2 CN3 W1		*	C91-1075-05	CERAMIC 470PF K							
			E23-0022-04	TERMINAL							
			E23-0462-05	TAB TERMINAL							
			E40-3237-05	MINI-CONNECTOR(2P)							
			E40-0470-05	PIN ASSY(4P)							
E31-0302-05	JUMPER WIRE										

E: Scandinavia & Europe K: USA P: Canada W: Europe

U: PX(Far East, Hawaii) T: England M: Other Areas

UE: AAFES(Europe) X: Australia

△ indicates safety critical components.

PS-52 (DC POWER SUPPLY)

* New Parts

Parts without Parts No. are not supplied.

Les articles non mentionnés dans le Parts No. ne sont pas fournis.

Telle ohne Parts No. werden nicht geliefert.

Ref. No. 参照番号	Address 位置	New Parts 新	Parts No. 部品番号	Description 部品名 / 規格	Desti- nation 仕 向	Re- marks 備考
			F29-0072-05	CONDENSER COVER		
			J13-0055-15	FUSE HOLDER		
			J31-0502-14	COLLAR(PC BOARD)		
			J42-0428-05	BUSHING(PC BOARD)		
R1			RD14BB2C391J	RD 390 J 1/6W		
R2			R92-1202-05	FUSE R 2.2 J 2W		
R3			RS14KB3F121J	FL-PROOF RS 120 J 3W		
R4			RD14BB2C272J	RD 2.7K J 1/6W		
R5			RD14BB2C102J	RD 1.0K J 1/6W		
R6			RD14BB2C473J	RD 47K J 1/6W		
R7 ,8			RS14KB3A1R0J	FL-PROOF RS 1.0 J 1W		
R9			RD14BB2C182J	RD 1.8K J 1/6W		
R10 ,11			RS14KB3A331J	FL-PROOF RS 330 J 1W		
R12			RD14BB2C471J	RD 470 J 1/6W		
R13			RD14BB2C472J	RD 4.7K J 1/6W		
R14			RD14BB2C153J	RD 15K J 1/6W		
R15			RS14KB2H471J	FL-PROOF RS 470 J 1/2W		
R16			RD14BB2C123J	RD 12K J 1/6W		
R17			RD14BB2C822J	RD 8.2K J 1/6W		
R18			RD14BB2C333J	RD 33K J 1/6W		
R19			RD14CB2C392J	RD 3.9K J 1/6W		
R20			RS14KB3A820J	FL-PROOF RS 82 J 1W		
R21			RD14BB2C223J	RD 22K J 1/6W		
R22			RD14BB2C472J	RD 4.7K J 1/6W		
VR1			R12-0094-05	TRIMMING POT.470		
VR2			R12-6012-05	TRIMMING POT.470K		
D1			1S1555	DIODE		
D2 ,3			DSA3A1	DIODE		
D4			UZ9.1BL	ZENER DIODE		
D5			1S1555	DIODE		
D6			UZ9.1BL	ZENER DIODE		
D7			UZ158H	DIODE		
D8			1S1555	DIODE		
Q1			2SA562(Y)	TRANSISTOR		
Q2 ,3			2SC2458(Y)	TRANSISTOR		
Q4			2SB941(Q)	TRANSISTOR		
Q5			2SC2458(Y)	TRANSISTOR		
TH-1			32D27	THERMISTER		
TH-2			5TP41L	THERMISTER		

E: Scandinavia & Europe K: USA P: Canada W: Europe

U: PX(Far East, Hawaii) T: England M: Other Areas

UE: AAFES(Europe) X: Australia

 indicates safety critical components.

TS-850S

PS-52 (DC POWER SUPPLY)

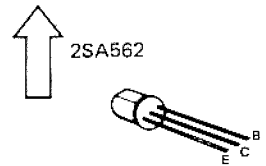
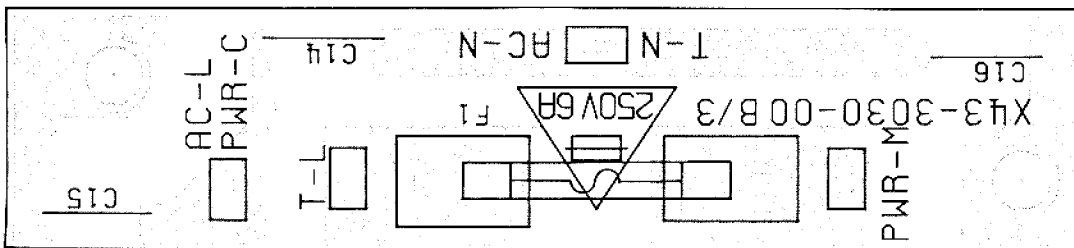
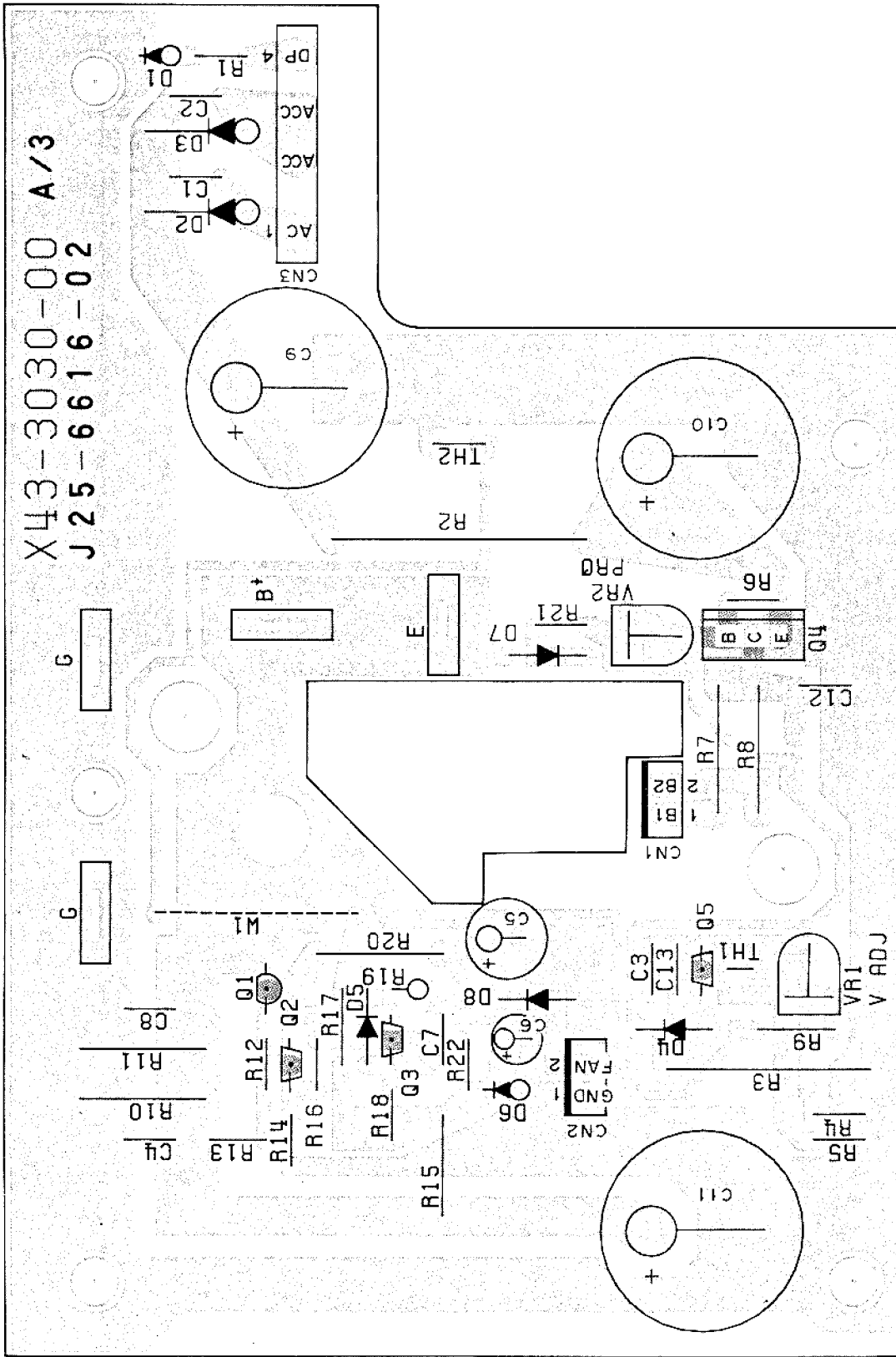

2SA562

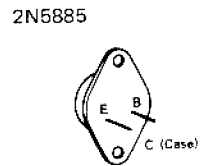

2N5885

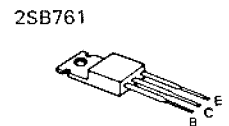

2SB761

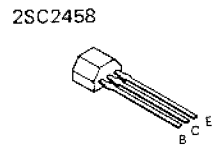

2SC2458

TS-850S TS-850S

PS-52 (DC POWER SUPPLY)

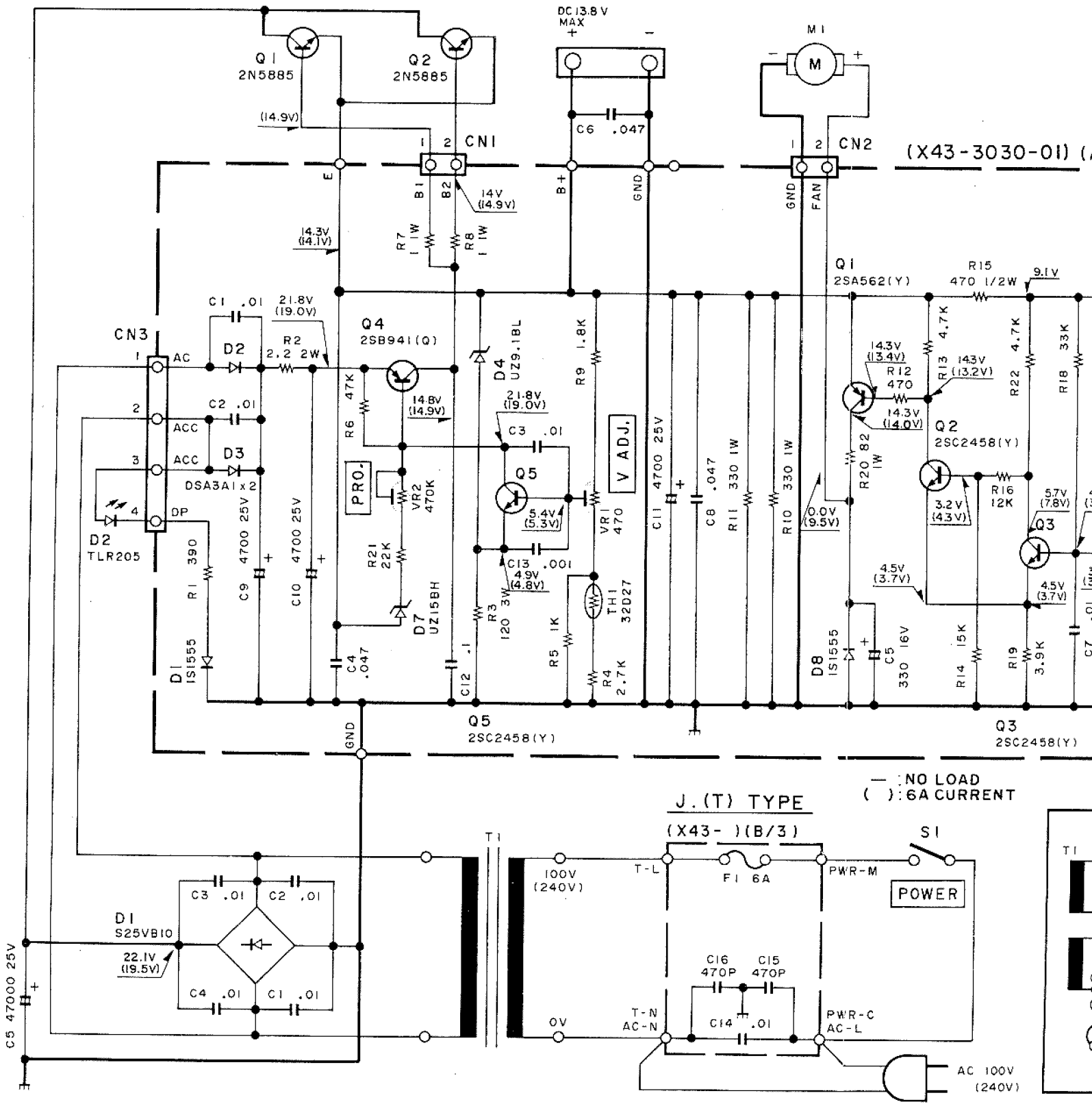

S-850S TS-850S

PS-52 (DC POWER SUPPLY)

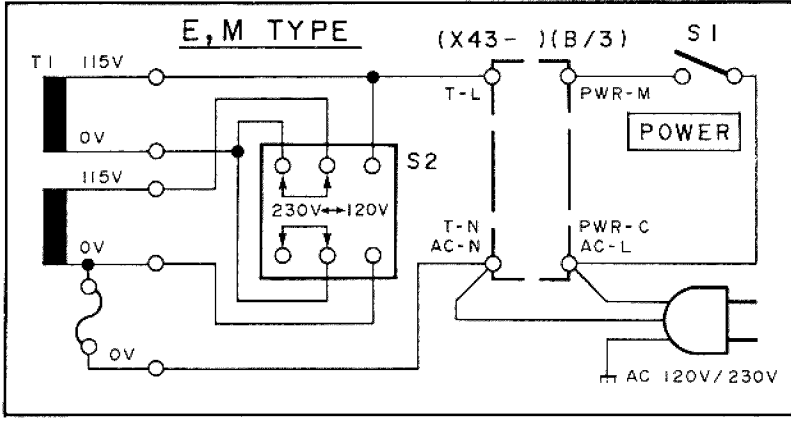
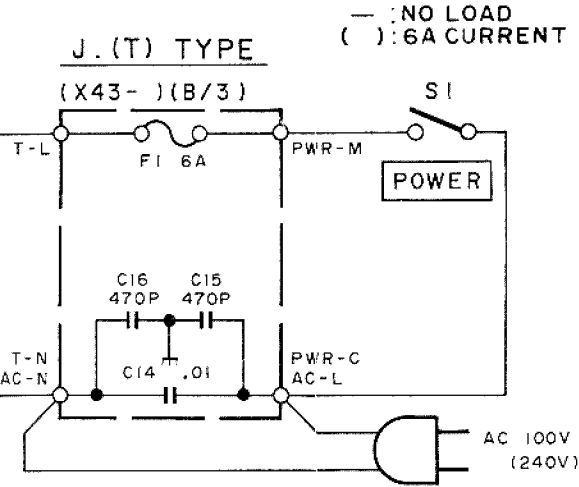
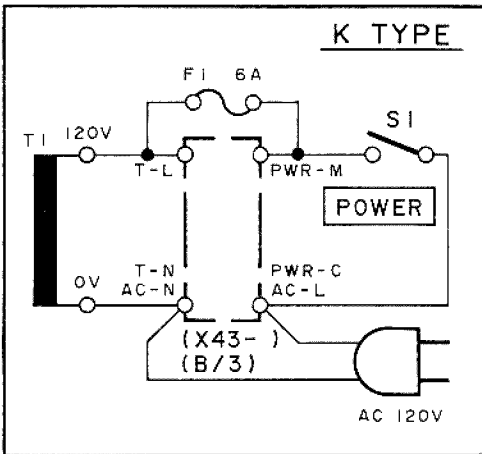
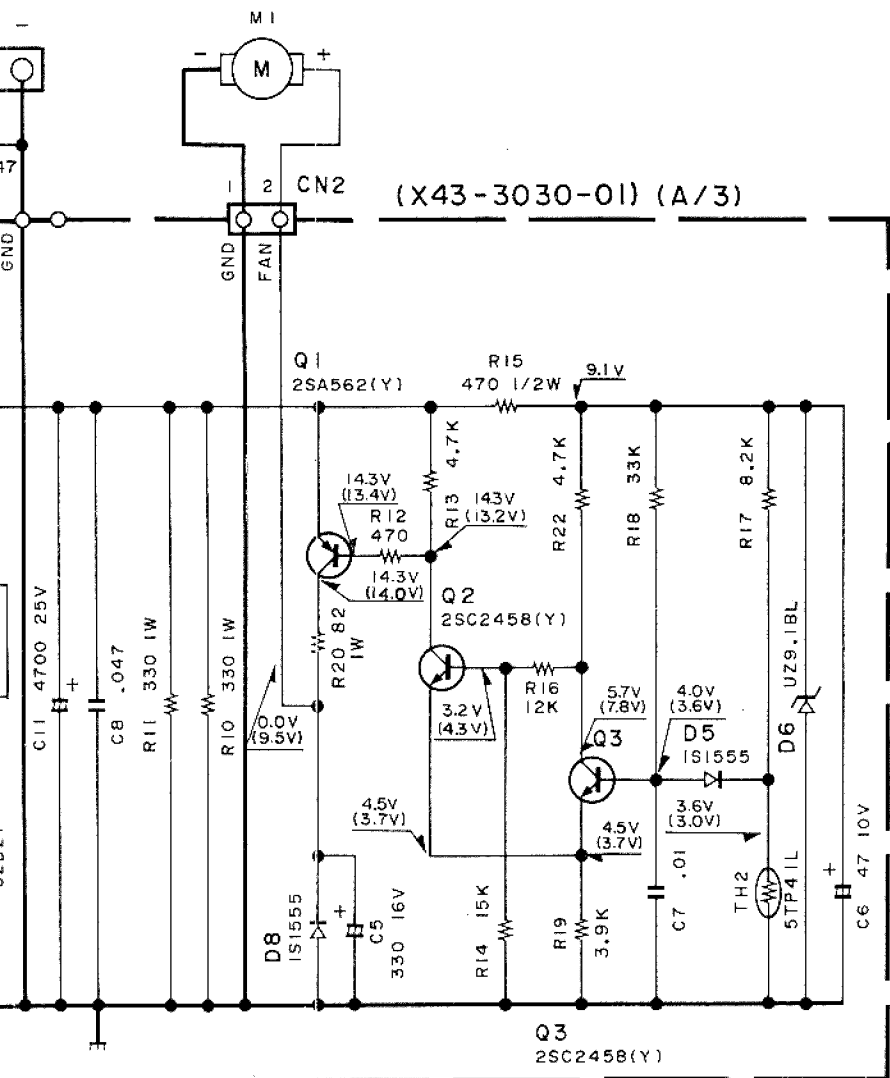

SP-31 (EXTERNAL SPEAKER)

SP-31 SPECIFICATIONS

Speaker used:	10 cm dia.
Rated Input:	2 Watts
Impedance:	8 Ω
Frequency response:	160 Hz to 7 kHz
Filter cut-off frequency:	
LOW:	400 Hz, - 3 dB
HIGH 1:	3.0 kHz, - 3 dB
HIGH 2:	1.2 kHz, - 2 dB
HIGH 1 + HIGH 2:	900 Hz, - 3 dB
Filter attenuation:	- 6 dB/oct.
Dimensions:	
W.	180 mm (7-1/16")
H.	120 mm (4-23/32")
D.	310 mm (12-7/32")
Net weight:	2.0 kg (4.4 lbs)

SP-31 PARTS LIST

Ref. No.	New Parts	Parts No.	Description
SP-31			
		A01-1051-02	Case (upper)
		A01-1052-02	Case (lower)
		A20-2656-03	Panel
		A23-2504-03	Rear panel
		B40-3812-04	Model name plate
		B50-8228-00	Instruction manual
		E14-0101-05	Pin plug (Accessory)
		E30-1711-15	Speaker cord (Accessory)
		G10-0662-04	Felt
		H01-8182-04	Item carton box
		H10-2644-02	Polystyrene foamed fixture
		H10-2645-02	Polystyrene foamed fixture
		H20-1433-03	Protection cover
		H25-0705-04	Portection bag
		J02-0049-14	Foot (rear)
		J02-0423-04	Foot (front outside)
		J02-0424-04	Foot (front inside)
		J19-1325-04	Mounting hardware (panel)
		J21-2788-04	Mounting hardware (speaker)
		J61-0307-05	Wire band
		K29-0758-14	Knob
		N33-3006-41	Round flat screw (case)
		N87-3006-41	Brazier head taptite screw
		N87-4008-41	Brazier head taptite screw
		T07-0225-15	Speaker
		X41-3060-00	Switch unit
SWITCH UNIT (X41-3060-00)			
C1		CE04BW1E470M	Electro 47 μ F 25WV
J1		E11-0432-05	Phone jack (PHONES)
J2		E20-0459-05	Speaker terminal board (4P)
J3		E13-0167-05	Pin jack (LINE OUT)
W1		E31-3426-05	Lead with connector
L1		L33-0706-05	Choke coil 0.55mH
L2		L33-0705-05	Choke coil 1.2mH
		N09-2048-05	Bind head screw
		N14-0404-04	Flange nut
R1, 2		RD14BB2E101J	RD resistor 100 J 1/4W
R3		RS14KB3D8R2J	RS resistor 8.2 J 2W
R4, 5		RD14BB2E102J	RD resistor 1k J 1/4W
S1		S40-2436-05	Push switch
S2		S42-3405-05	Push switch

SP-31 (EXTERNAL SPEAKER)

SP-31 SCHEMATIC DIAGRAM

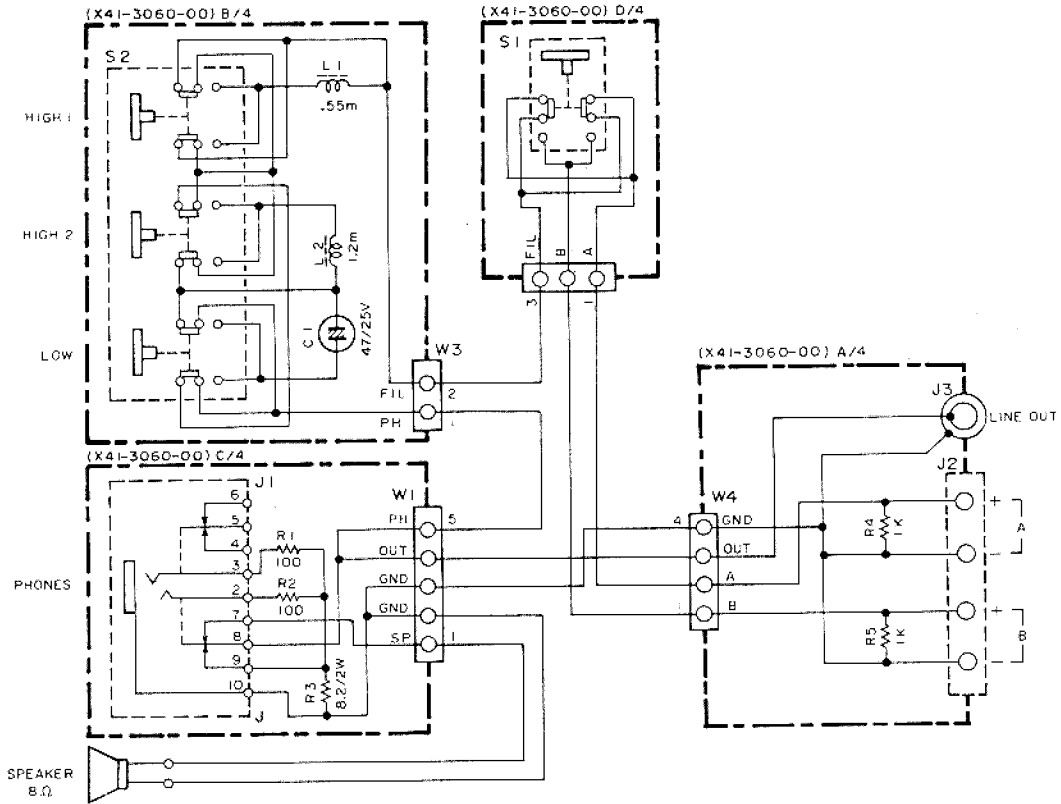

SP-31 PC BOARD VIEW

SWITCH UNIT (X41-3060-00) Component side view

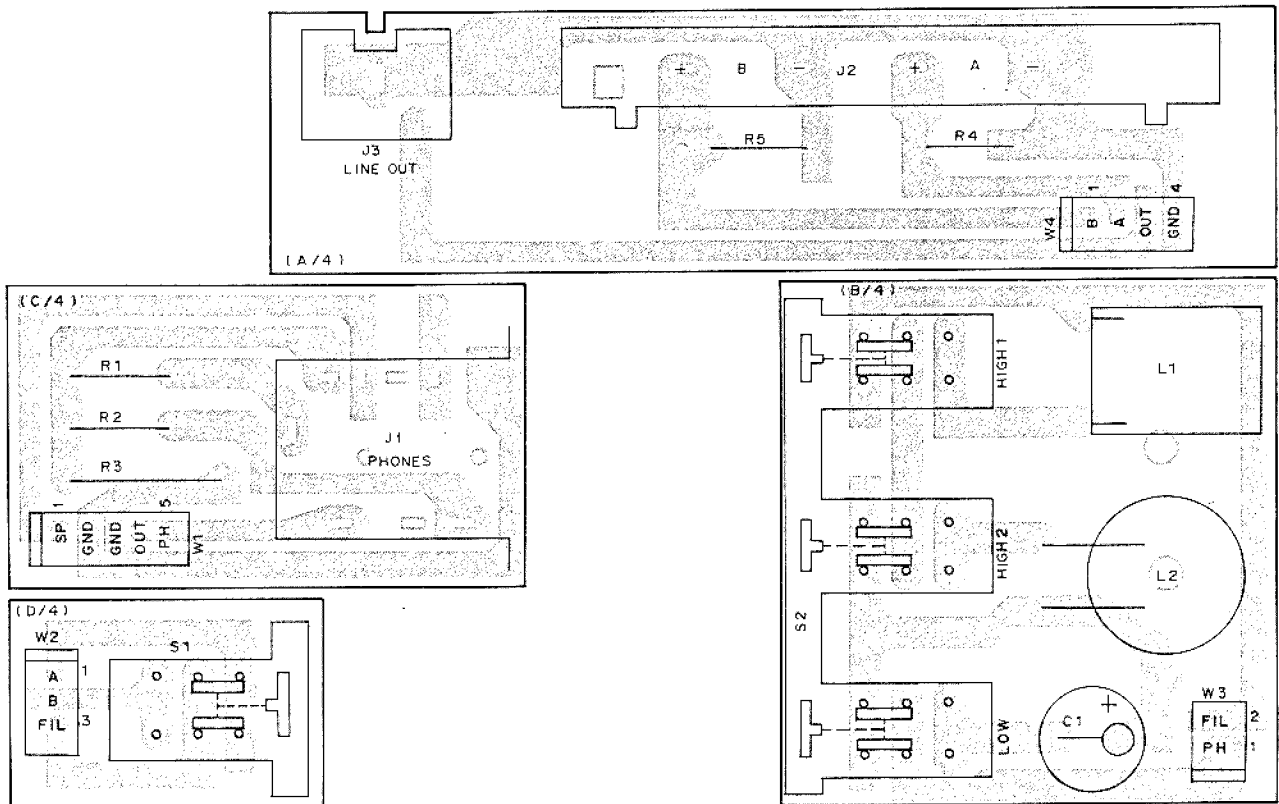

VS-2 (VOICE SYNTHESIZER)

VS-2 PARTS LIST

Ref. No.	New Parts	Parts No.	Description
VS-2			
		B50-8095-00	Instruction manual
		G13-0645-04	Cushion Accessory
		H01-8025-03	Item carton box
		H25-0029-04	Protection bag
		N32-2004-41	Flat head screw
		N35-2604-41	Bind head screw
		X42-3000-00	Accessory unit
ACCESSORY UNIT (X42-3000-00)			
C6,7		CC73ECH1H202J	Chip C 2000pF J
C2,3,9		CC73FCH1H331J	Chip C 330pF J
C8		CC73FCH1H471J	Chip C 470pF J
C12		CE04CW1A330M	Electro 33μF 10WV
C1,5		CK73EB1E104K	Chip C 0.1μF K
C10		CK73EB1H473K	Chip C 0.047μF K
C13		C90-0503-05	Chip tan 0.068μF 35WV
C4,11		C92-0501-05	Chip tan 1.5μF 10WV
CN1		E40-5022-05	Pin ass'y (8P)
		J21-4146-04	Mounting hardware
X1		L78-0006-05	Ceramic oscillator
R3		RK73FB2A101J	Chip R 100 J 1/10W
R13		RK73FB2A102J	Chip R 1k J 1/10W
R1		RK73FB2A105J	Chip R 1M J 1/10W
R4,15		RK73FB2A153J	Chip R 15k J 1/10W
R10,14		RK73FB2A183J	Chip R 18k J 1/10W
R8,12		RK73FB2A472J	Chip R 4.7k J 1/10W
R2,5		RK73FB2A473J	Chip R 47k J 1/10W
R11		RK73FB2A682J	Chip R 6.8k J 1/10W
R6,7		RK73FB2A683J	Chip R 68k J 1/10W
R9		RK73FB2A822J	Chip R 8.2k J 1/10W
VR1		R12-3457-05	Trimming pot. 47k
S1		S31-1418-05	Slide switch
IC1		MN6401TRA	IC
IC2		NJM2904M	IC
IC3		TC74HC164FP	IC
IC3		HD74HC164FP	IC

VS-2 SCHEMATIC DIAGRAM

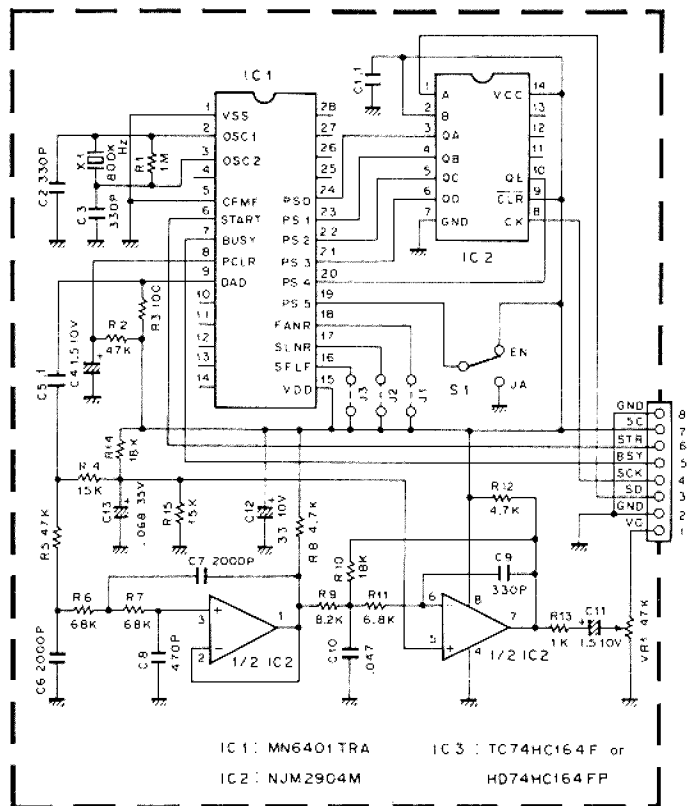

VS-2 PC BOARD VIEW

ACCESSORY UNIT (X42-3000-00)

Component side view

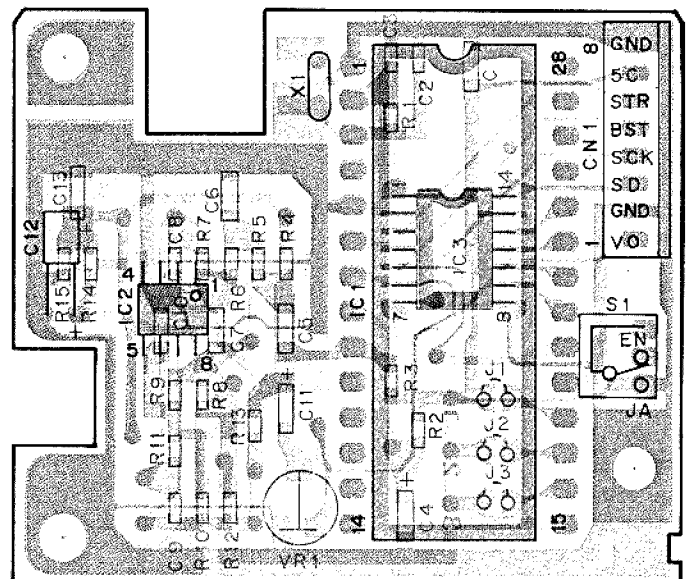

SO-2 (TCXO UNIT)

SO-2 External view

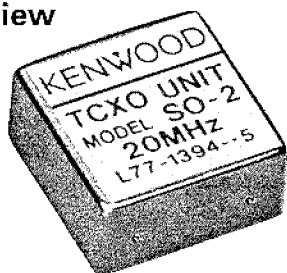

SO-2 Specifications

Oscillating frequency 20 MHz
Temperature stability $\pm 5 \times 10^{-7}$ (-10°C to $+50^{\circ}\text{C}$)
Frequency stability (Long term) $\pm 1 \times 10^{-6}$ /year
Output 1 V peak-to-peak (20 k Ω /5 pF)

SO-2 Parts list

Ref. No.	New	Parts No.	Description
		B50-8314-08	Instruction manual
		L77-1394-15	TCXO

SPECIFICATIONS

Specifications	Model	TS-850S		
General				
Mode	J3E (LSB, USB), A1A (CW), A3E (AM), F3E (FM), F1A (FSK)			
Memory channels	100			
Antenna impedance	50Ω (With AT-850 antenna tuner 20 to 150Ω)			
Power requirement	12 to 16V DC (13.8V DC reference)			
Grounding	Negative			
Current drain	Receive mode with no input signal	2A		
	Transmit mode	20.5A		
Operating temperature	-10 to +50°C (+14 to +122°F)			
Frequency stability	Less than ±10 PPM			
Frequency accuracy	Less than ± 10 PPM			
Dimensions (W x H x D) (Projections included)	339 x 135 x 375 mm (13-11/32" x 5-5/16" x 14-3/4")			
Weight	With AT unit	10.9kg (24lbs)		
	Without AT unit	9.4kg (20.7lbs)		
Frequency range	160m band	1.8 to 2.0 MHz		
	80m band	3.5 to 4.0MHz		
	40m band	7.0 to 7.3MHz		
	30m band	10.1 to 10.15MHz		
	20m band	14.0 to 14.35MHz		
	17m band	18.068 to 18.168MHz		
	15m band	21.0 to 21.45MHz		
	12m band	24.89 to 24.99MHz		
	10m band	28.0 to 29.7MHz		
Output power	1.9 to 24.5MHz	SSB, CW, FSK, FM	MAX	100W
			MIN	20W
		AM	MAX	40W
			MIN	10W
	28MHz	SSB, CW, FSK, FM	MAX	100W
			MIN	20W
		AM	MAX	40W
			MIN	10W
Modulation	SSB		Balanced modulation	
	FM		Reactance modulation	
	AM		Low level modulation	
Spurious radiation			Less than -60dB	
Carrier suppression (with 1.5kHz reference)			More than 40dB	
Unwanted sideband suppression (with 1.5kHz reference)			More than 40dB	
Maximum frequency deviation (FM)			Less than ±5kHz	
Frequency response (-6dB)			400 to 2600Hz	
XIT variable range	10Hz step	More than ±1.2kHz		
	20Hz step	More than ±2.4kHz		
Microphone impedance			600Ω	
Transmitter				

SPECIFICATIONS

Specifications		Model	TS-850S	
Circuitry		Triple conversion superheterodyne		
Frequency range		100kHz to 30MHz		
Intermediate frequency		1st : 73.05MHz, 2nd : 8.83MHz, 3rd : 455kHz		
Receiver	Sensitivity	SSB, CW, FSK (at 10dB S + N/N)	10kHz to 500kHz	Less than 0.2 μ V
			500kHz to 1.62MHz*	Less than 4 μ V
			*1.62MHz to 24.5MHz	Less than 0.2 μ V
	AM (at 10dB S + N/N)	100kHz to 500kHz	Less than 2 μ V	
		500kHz to 1.62MHz*	Less than 32 μ V	
		*1.62MHz to 24.5MHz	Less than 2 μ V	
	FM (at 12dB SINAD)	24.5MHz to 30MHz	Less than 1.3 μ V	
		28MHz to 30MHz	Less than 0.25 μ V	
	Selectivity	SSB, CW, FSK	-6dB : 2.4kHz, -60dB : 3.8kHz	
AM			-6dB : 6kHz, -60dB : 15kHz	
FM			-6dB : 12kHz, -60dB : 24kHz	
Image ratio		More than 80dB		
1st IF rejection		More than 80dB		
Notch filter attenuation		More than 40dB		
RIT variable range		10Hz step	More than \pm 1.2kHz	
		20Hz step	More than \pm 2.4kHz	
Squelch	SSB, CW, FSK, AM	100kHz to 500kHz	Less than 2 μ V	
		500kHz to 1.62MHz*	Less than 20 μ V	
		*1.62MHz to 30MHz	Less than 2 μ V	
	FM	28MHz to 30MHz	Less than 0.25 μ V	
Output		1.5W across 8 Ω load (10% distortion)		
Output load impedance		8 Ω		

Notes

1. Circuit and ratings are subject to change without notice due to advancements in technology.
2. Remember to keep the transmit output power within the power limitations of your license.
3. * : the U.S.A. version is 1.705MHz.

KENWOOD CORPORATION

Shionogi Shibuya Building, 17-5, 2-chome Shibuya, Shibuya-ku, Tokyo 150, Japan

KENWOOD U.S.A. CORPORATION

COMMUNICATIONS & TEST EQUIPMENT GROUP

P.O. BOX 22745, 2201 East Dominguez St., Long Beach, CA 90801-5745, U.S.A.

KENWOOD ELECTRONICS DEUTSCHLAND GMBH

Rembrücker Str. 15, 6056 Heusenstamm, Germany

TRIO-KENWOOD U.K. LIMITED

KENWOOD House, Dwight Road, Watford, Herts., WD1 8EB United Kingdom

KENWOOD ELECTRONICS BENELUX N.V.

Mechelsesteenweg 418 B-1930 Zaventem, Belgium

TRIO-KENWOOD FRANCE S.A.

13, Boulevard Ney, 75018 Paris, France

KENWOOD LINEAR S.P.A.

20125, Milano-via Arbe, 50, Italy

KENWOOD ELECTRONICS AUSTRALIA PTY. LTD.

P.O. Box 504, 8 Figtree Drive, Australia Centre, Homebush, N.S.W. 2140, Australia

KENWOOD & LEE ELECTRONICS, LTD.

Wang Kee Building, 5th Floor, 34-37, Connaught Road, Central, Hong Kong

KENWOOD ELECTRONICS CANADA INC.

P.O. BOX 1075, 959 Gana Court, Mississauga, Ontario, Canada L4T 4C2