

RF Power Amplifier Module

VHF Power Amplifier Module (HAM FM)

Features

- Output Power : $P_o \geq 15W$
- Minimum Gain : $G_p = 18.7dB$
- Efficiency : $\eta_T \geq 48\%$
- 50Ω Input/Output Impedance
- Guaranteed Stability

Absolute Maximum Ratings (Tc = 25°C)

CHARACTERISTIC	SYMBOL	RATING	UNIT
DC Supply Voltage	V_{CC}	16	V
DC Supply Voltage	V_{CON}	16	V
RF Input Power	P_i	300	mW
Operating Case Temperature Range	$T_c(OP)$	-30 ~ 100	°C
Storage Temperature Range	T_{sig}	-40 ~ 110	°C

Electrical Characteristics (Tc = 25°C)

CHARACTERISTIC	SYMBOL	TEST CONDITION	MIN.	TYP.	MAX.	UNIT
Frequency Range	f_{range}	—	144	—	148	MHz
Output Power	P_o	$P_i = 200mW$ $V_{CC} = 12.5V, V_{CON} = 12.5V$ $Z_g = Z_l = 50\Omega$	15	20	—	W
Power Gain	G_p		18.7	20	—	dB
Total Efficiency	η_T		48	53	—	%
Input VSWR	$VSWR_{in}$		—	1.5	2	—
Harmonics	HRM		—	-30	-25	dB
Load Mismatch	—	$V_{CC} = 15V, V_{CON} = 12.5V$ $P_o = 18W$ VSWR Load 20:1 all phase	No Degradation			—
Stability	—	$V_{CC} = 12.5V, P_i = 200mW$ $V_{CON} = 0 \sim 12.5V$ VSWR Load 3:1 all phase	All spurious output than 60dB below desired signal			—

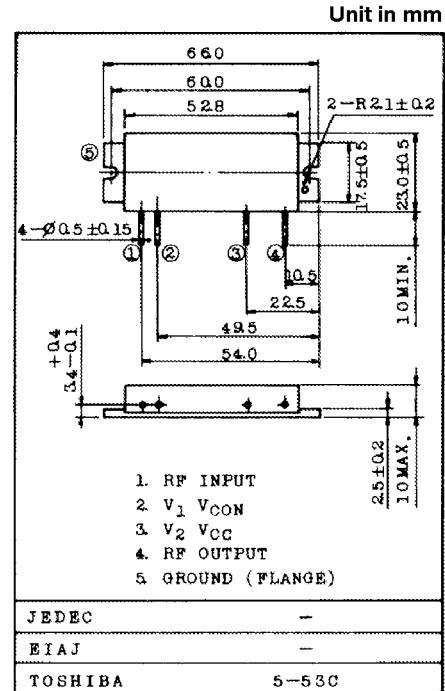

SCHEMATIC

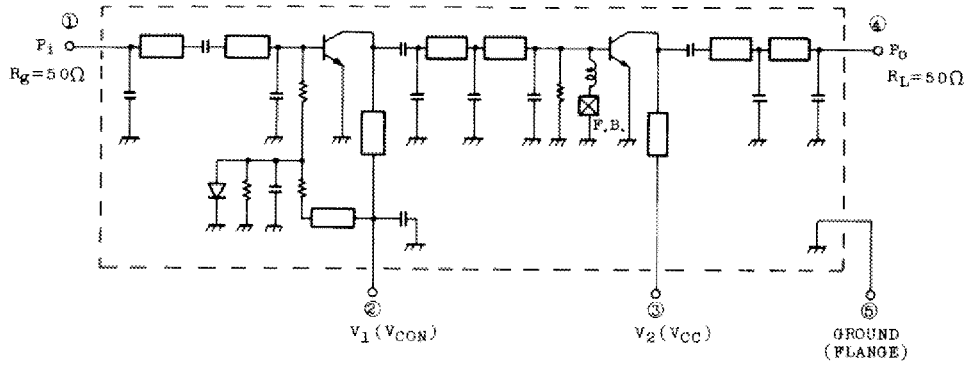

TEST MOUNT

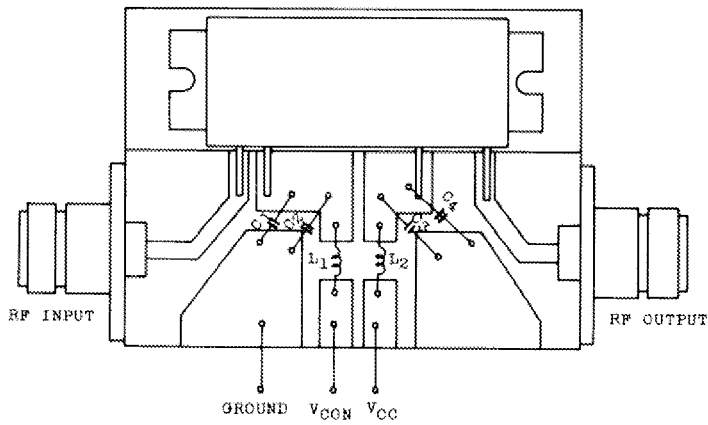

C₁, C₃ : 15000PF

C₂, C₄ : 1μF

L₁, L₂ : Ø0.8 PLATED WIRE 8T, 5ID

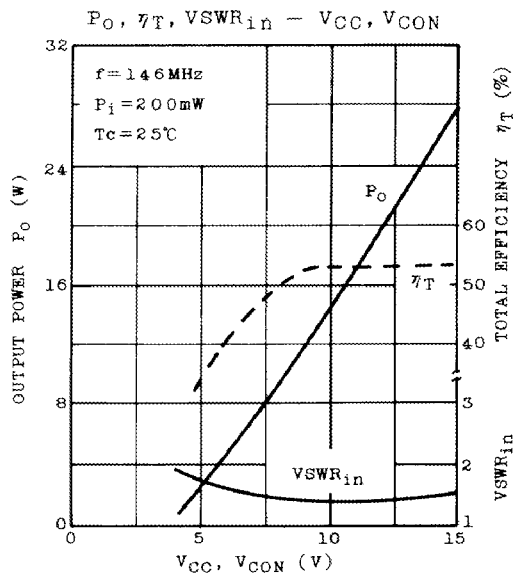
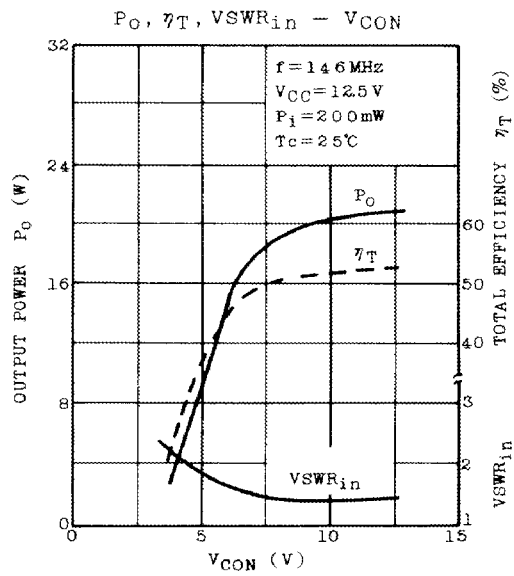
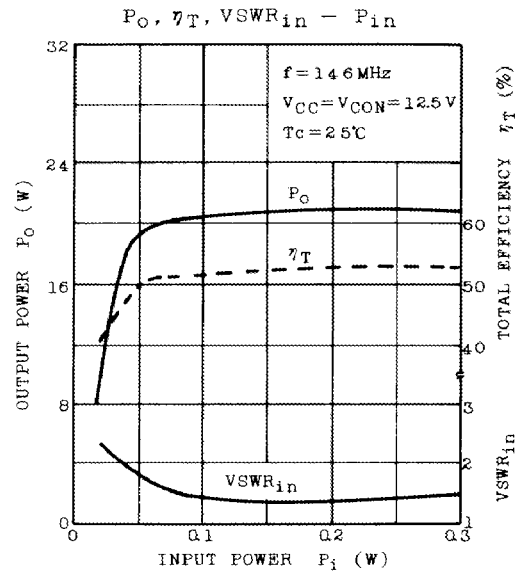
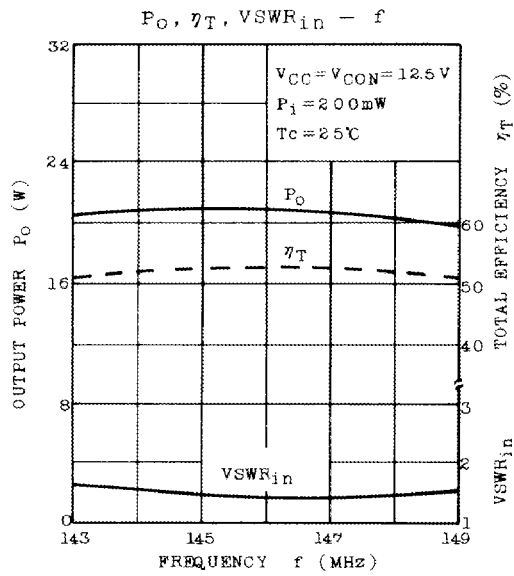

This datasheet has been downloaded from:

www.DatasheetCatalog.com

Datasheets for electronic components.