

ICOM

INSTRUCTION MANUAL

DUAL BAND FM TRANSCEIVER

IC-2340H

IC-2340A

IC-2340E

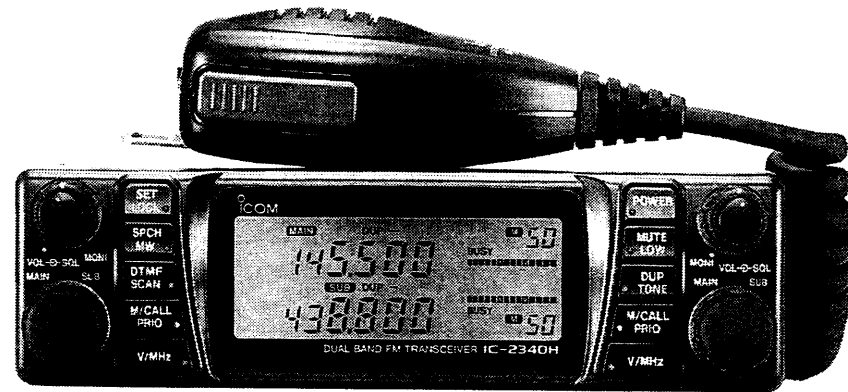

Icom Inc.

IMPORTANT

READ ALL INSTRUCTIONS carefully and completely before using the transceiver.

SAVE THIS INSTRUCTION MANUAL. This instruction manual contains important safety and operating instructions for the IC-2340H/A/E.

EXPLICIT DEFINITIONS

The following explicit definitions apply to this manual.

Word	Definition
WARNING	Personal injury, fire hazard or electric shock may occur.
CAUTION	Equipment damage may occur.
NOTE	If disregarded, inconvenience only. No personal injury, risk of fire or electric shock.

INCLUDED ACCESSORIES

Refer to p. 55 "Unpacking" for included accessories.

CAUTIONS

NEVER connect the transceiver to an AC outlet or to a power source of more than 16 V DC. These connections will ruin the transceiver.

NEVER connect the transceiver to a power source using reverse polarity. This connection will ruin the transceiver.

NEVER place the transceiver where normal operation of the vehicle may be hindered or where it could cause bodily injury.

NEVER let objects touch the cooling fan on the rear panel.

NEVER allow children to touch the transceiver.

DO NOT use or place the transceiver in areas with temperatures below -10°C ($+14^{\circ}\text{F}$) or over $+60^{\circ}\text{C}$ ($+140^{\circ}\text{F}$) or, in areas subject to direct sunlight, such as the dashboard.

BE CAREFUL! The transceiver will become hot when operating the transceiver continuously for long periods.

TABLE OF CONTENTS

1 PANEL DESCRIPTION	1-6	■ Call channel contents transferring	22	15 HM-77/A ADVANCED FUNCTIONS	38-41
■ Front panel	1			■ General description	38
■ Function display	3	8 SCRATCH PAD OPERATION	23	■ DTMF memory operation	38
■ Rear panel	5	■ What are scratch pad memories?	23	■ Re-dialing	40
■ Microphone	6	■ Scratch pad recalling	23	■ 1750 Hz tone call	41
		■ Scratch pad contents transferring	23	■ Microphone CPU resetting	41
2 INSTALLATION	7-10	9 SCAN OPERATION	24-27	16 OPTIONAL DTMF REMOTE	42-45
■ Location	7	■ Scan types	24	■ General description	42
■ Mounting	7	■ Full scan and programmed scan	25	■ Mic DTMF remote operation	42
■ Microphone connector attachment	8	■ Memory scan	26	■ External DTMF remote presetting	43
■ Battery connection	8			■ External DTMF remote operation	43
■ Antenna installation	9	10 PRIORITY WATCH	28-29	■ Remote function tables	44
■ Optional unit installation	10	■ Priority watch types	28	■ Remote operation examples	45
		■ Priority watch operation	29		
3 FREQUENCY SETTING	11-13	11 SUB BAND FUNCTIONS	30	17 OTHER FUNCTIONS	46-48
■ Pre-operation	11	■ SUB band access	30	■ Display dimmer	46
■ Using tuning dials	12	■ SUB band mute/SUB busy beep	30	■ Optional voice synthesizer	46
■ Using [UP]/[DN] switches	12			■ Beep tones	47
■ Frequency lock function	13	12 TONE FUNCTIONS	31-32	■ Mono band operation	47
■ Tuning steps	13	■ Function availability	31	■ Time-out timer	47
		■ Pocket beep operation	31	■ Auto power-off	48
4 BASIC OPERATION	14-15	■ Tone squelch operation	31	■ Cooling fan	48
■ Receiving	14	■ Tone scan operation	32	■ Demonstration indication	48
■ Transmitting	15				
		13 PAGER AND CODE SQUELCH	33-36	18 MODE ARRANGEMENT CHART	49-50
5 REPEATER OPERATION	16-18	■ Function availability	33	19 MAINTENANCE	51-53
■ Accessing	16	■ What is pager?	33	■ Troubleshooting	51
■ Tone frequency	17	■ Code channel	34	■ Partial resetting	53
■ Offset frequency	17	■ Code programming	35	■ Total resetting	53
■ Auto repeater	18	■ Pager operation	35	■ Cleaning	53
		■ What is code squelch?	36	■ Fuse replacement	53
6 MEMORY OPERATION	19-21	■ Code squelch operation	36	■ Lithium battery	53
■ General description	19			20 SPECIFICATIONS	54
■ Memory selection	19	14 UP SWITCH REMOTE	37	21 UNPACKING AND OPTIONS	55-56
■ Memory programming	20	■ What is up switch remote?	37	■ Unpacking	55
■ Memory contents transferring	21	■ Up switch remote programming	37	■ Options	55
7 CALL CHANNEL OPERATION	22				
■ Call channel recalling	22				
■ Call channel programming	22				

Front panel

Most switches have primary and secondary functions. When pushed, the primary function is selected. When pushed and held, the secondary function is selected.

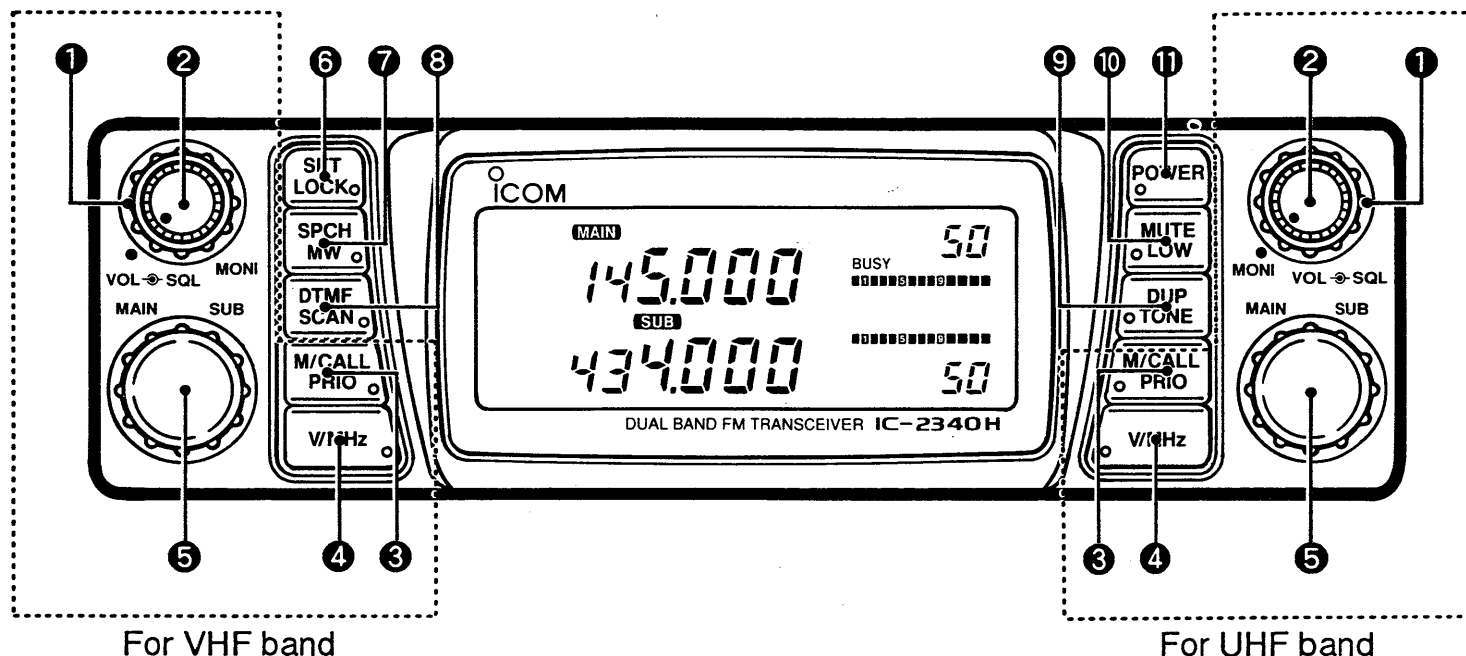

❶ SQUELCH CONTROLS [SQL]

Adjust the squelch threshold level. (p. 14)

❷ VOLUME CONTROLS [VOL•MONI]

- Adjust the audio level. (p. 14)
- Open the squelch and monitor the transmit frequency when pushed and held. (pgs. 14, 16)

❸ MEMORY/CALL CHANNEL SWITCHES [M/CALL•PRIO]

- Select MEMORY mode or a call channel. (pgs. 19, 22)
- Activate the priority watch function when pushed and held. (p. 29)
- Cancel the priority watch function. (p. 29)

④ VFO/MHz SWITCHES [V/MHz]

- Select VFO mode when a memory channel, call channel or scratch pad memory is selected. (p. 11)
- Select the 1 MHz tuning step while in VFO mode. (p. 12)
- For some versions, select the 10 MHz tuning step when pushed and held while in VFO mode. (p. 12)

⑤ TUNING DIALS [MAIN•SUB]

- Select an operating frequency or memory channel. (pgs. 12, 19)
- Select a scratch pad memory when a call channel is selected. (p. 23)
- Assign the MAIN band when pushed. (p. 11)
- Activate and cancel the SUB band access function when pushed and held. (p. 30)

⑥ SET MODE SWITCH [SET•LOCK]

- Selects SET mode. (p. 50)
- Activates and cancels the frequency lock function when pushed and held. (p. 13)

⑦ SPEECH/MEMORY WRITE SWITCH [SPCH•MW]

- Activates the optional voice synthesizer function. (p. 46)
- Programs a memory channel or call channel when pushed and held while in VFO mode. (pgs. 20, 22)
- Transfers a memory channel, call channel or scratch pad memory contents into the VFO when pushed and held. (pgs. 21, 22, 23)

⑧ DTMF/SCAN SWITCH [DTMF•SCAN]

When pushed		Activates and cancels the optional pager, code squelch function or remote standby condition. (pgs. 35, 36, 42, 43)
When pushed and held	While in VFO mode	Starts full scan or programmed scan. (p. 25)
	While in MEMORY mode	Starts memory scan. (p. 26)
	While the optional tone squelch function is in use	Starts the optional tone scan function. (p. 32)

⑨ DUPLEX/TONE SWITCH [DUP•TONE]

- Selects simplex, "DUP -" or "DUP." (p. 16)
- Activates the subaudible tone encoder* when pushed and held. (p. 16)
- * Non-U.S.A. versions have 88.5 Hz only.
- After installing an optional UT-89, alternately selects the subaudible tone encoder, pocket beep and tone squelch function when pushed and held. (pgs. 16, 31)

⑩ MUTE/TRANSMIT POWER SWITCH [MUTE•LOW]

- Mutes both MAIN and SUB band audio signals. (p. 14)
- Selects the transmit output power levels when pushed and held. (p. 15)

⑪ POWER SWITCH [POWER]

- Turns the power ON and OFF when pushed and held. (p. 11)

1 PANEL DESCRIPTION

Function display

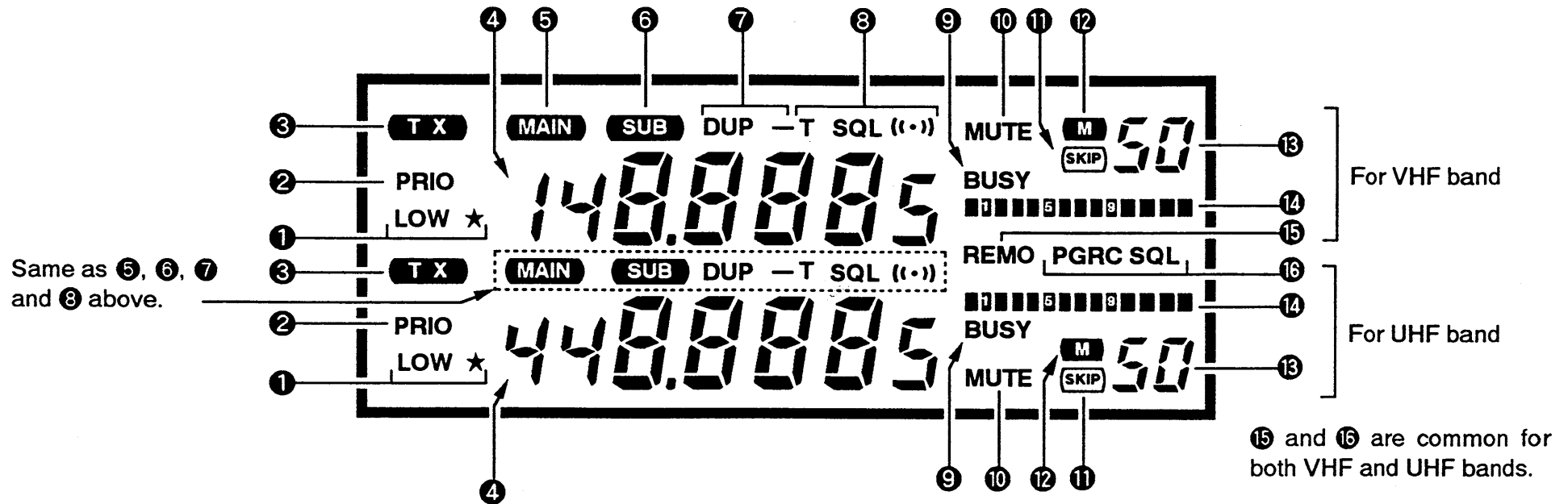

① LOW POWER INDICATORS

Disappear	While high is selected. (p. 15)
"LOW ★"	While low 2 (middle) is selected. (p. 15)
"LOW"	While low 1 (lowest) is selected. (p. 15)

② PRIORITY WATCH INDICATORS

- Appear while the priority watch is activated. (p. 29)
- Blink while the priority watch is paused. (p. 29)

③ TRANSMIT INDICATORS

Appear while transmitting. (p. 15)

④ FREQUENCY READOUTS

Show the operating frequency.

⑤ MAIN BAND INDICATORS

Appear while a band is assigned as the MAIN band. (p. 11)

⑥ SUB BAND ACCESS INDICATORS

- Appears while the SUB band is accessed. (p. 30)
- Blink while the optional external DTMF remote is in use. (p. 43)

7 DUPLEX INDICATORS

“DUP –” or “DUP” appear during semi-duplex operation for repeater accessing. (p. 16)

8 TONE INDICATORS

“T”	While the subaudible tone encoder is in use. (p. 16)
“TSQL”	While the optional tone squelch function is in use. (p. 31)
“T SQL ((•))”	While the optional pocket beep function is in use. (p. 31)

9 BUSY INDICATORS

Appear when a channel is busy. (p. 14)

10 MUTE INDICATORS

“MUTE” ’s for both bands	Appear while mute function is in use. (p. 14)
“MUTE” for the SUB band	Appears while the SUB band mute function is in use, and signals are received on both bands. (p. 30)





11 SKIP INDICATORS

Appear when the displayed memory channel is specified as a skip channel. (p. 27)

12 MEMORY INDICATORS

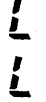
Appear when MEMORY mode is selected. (p. 19)

13 MEMORY CHANNEL READOUTS

Memory channel number	
	While in MEMORY mode or VFO mode.
	While the frequency lock function is in use. (p. 13)
	When VFO mode is selected from a call channel, or scratch pad memory. (p. 22)
	When a call channel is selected. (p. 22)
	When a duplex scratch pad is selected. (p. 23)
	When a simplex scratch pad is selected. (p. 23)

14 S/RF INDICATORS

- Show the signal strength while receiving. (p. 14)
- Show the output power level while transmitting. (p. 15)

15 REMOTE INDICATOR

- Appears during optional remote standby condition. (pgs. 42, 43)
- Blinks while optional mic DTMF remote or external DTMF remote is in use. (pgs. 42, 43)

16 PAGER/CODE SQUELCH INDICATORS

- “PGR” appears while the optional pager function is in use. (p. 35)
- “C SQL” appears while the optional code squelch function is in use. (p. 36)

1 PANEL DESCRIPTION

■ Rear panel

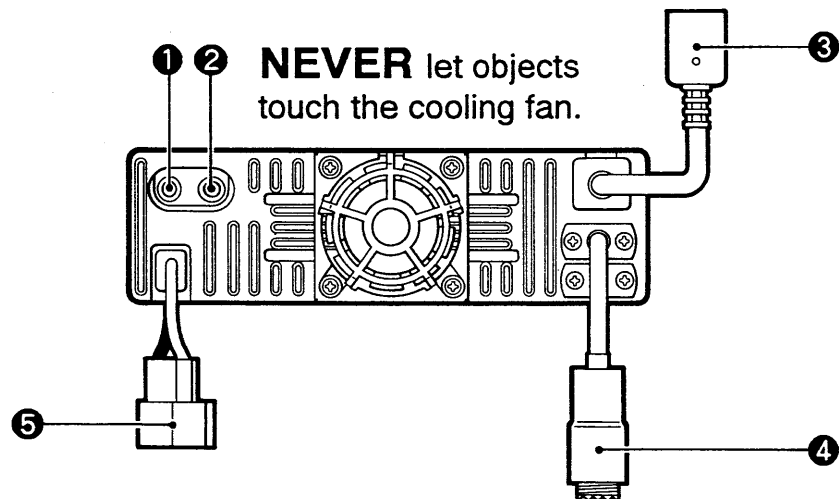

① 430 (440) MHz SPEAKER JACK [430MHz (440MHz) SP]

Connects a 4–8 Ω speaker, if required.

② 144 MHz SPEAKER JACK [144MHz SP]

Connects a 4–8 Ω speaker, if required.

③ MICROPHONE CONNECTOR [MIC]

Connects the supplied microphone.

④ ANTENNA CONNECTOR [ANT]

Accepts a 50 Ω dual band antenna with a PL-259 connector. (p. 9)

⑤ POWER RECEPTACLE [DC13.8V]

Accepts 13.8 V DC with the supplied DC power cable. (p. 8)

◇ Microphone connector information

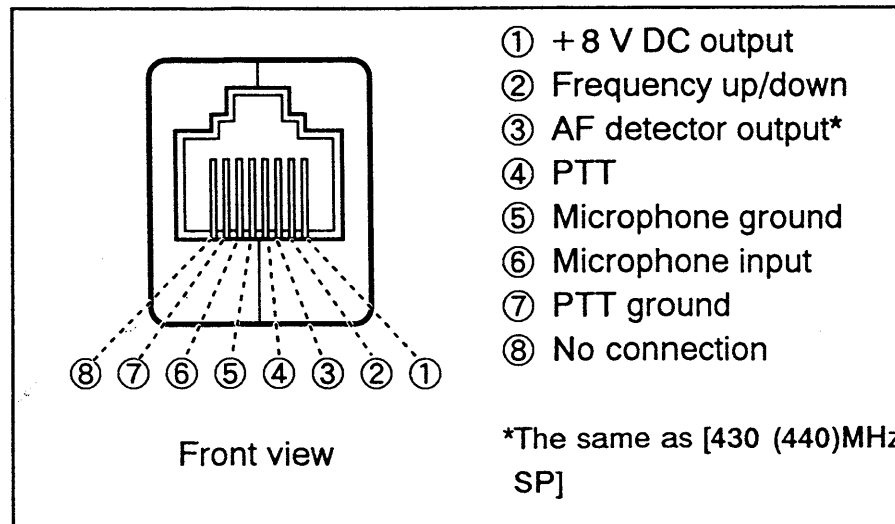

◇ Speaker jack information

Connected speaker	VHF band audio	UHF band audio
With no external speakers	Internal speaker (mixed audio)	
[144MHz SP] only	External speaker	Internal speaker
[430 (440)MHz SP] only	External speaker (mixed audio)	
2 external speakers	External speaker via [144MHz SP]	External speaker via [430 (440)MHz SP]

Microphone

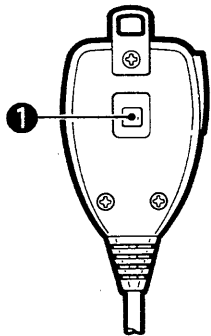

HM-79 rear panel
(Europe and Italy versions)

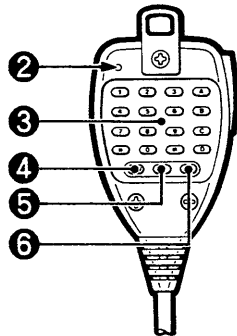

HM-77/A rear panel
(U.S.A. and Korea versions)

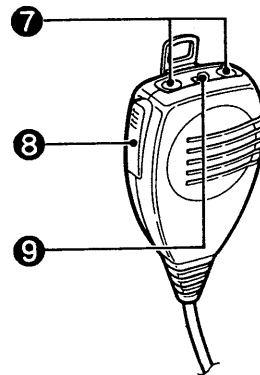

Top and side panels

- 1 TONE CALL SWITCH [TONE]** (HM-79 only)
Push and hold to transmit a 1750 Hz tone call signal for repeater access. (p. 16)
- 2 ACTIVE INDICATOR** (HM-77/A only)
- Lights up when the DTMF keyboard is pushed.
- Blinks while DTMF memory transmitting. (p. 39)
- 3 DTMF KEYBOARD** (HM-77/A only)
Use DTMF codes for auto patching, repeater control, optional mic DTMF remote and other functions. (p. 16)
- 4 MEMORY WRITE KEY [MW]** (HM-77/A only)
Used when writing a DTMF code into DTMF memory or re-dial memory. (pgs. 38, 40)
- 5 MEMORY READ KEY [MR]** (HM-77/A only)
Used to transmit DTMF memory contents. (p. 39)

- 6 RE-DIAL KEY [RD]** (HM-77/A only)
Used to transmit the last-transmitted DTMF code. (p. 40)
- 7 UP/DOWN SWITCHES [UP]/[DN]**

During normal condition	<ul style="list-style-type: none"> - When pushed: Change the operating frequency, memory channel or scratch pad memory. (pgs. 12, 19, 23) - When pushed and held: Start scanning. (pgs. 25, 26)
While up switch remote is in use	<ul style="list-style-type: none"> - When [UP] is pushed : Activates allocated primary function. (p. 37) - When [UP] is pushed and held : Activates allocated secondary function. (p. 37) - When [DN] is pushed: Starts scanning. (pgs. 25, 26)
During optional remote standby condition	<ul style="list-style-type: none"> - When [UP] is pushed: Activates the optional mic DTMF remote. (p. 42) - When [DN] is pushed: Starts scanning. (pgs. 25, 26)

- 8 PTT SWITCH**
Push and hold to transmit; release to receive. (p. 15)
- 9 LOCK SWITCH [LOCK]**
Prevents accidental key entry except the PTT switch and [TONE] on the HM-79 HAND MICROPHONE. (p. 12)

Location

Select a location which can support the weight of the transceiver and does not interfere with driving in any way.

NEVER place the transceiver where normal operation of the vehicle may be hindered or where it could cause bodily injury.

NEVER place the transceiver where air bag operation may be obstructed.

DO NOT place the transceiver where hot or cold air blows directly onto it.

AVOID placing the transceiver in direct sunlight.

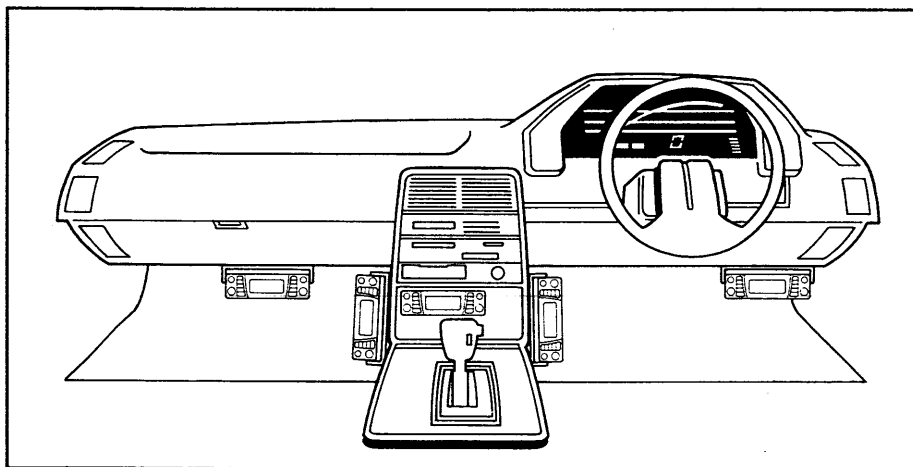

Mounting

- ① Drill 4 holes for the mounting bracket.
 - When using nuts: approx. 5.5–6 mm; 11/64–3/16 in
 - When using self-tapping screws: approx. 2–3 mm; 1/16–3/32 in
- ② Insert the supplied screws, nuts, washers through the mounting bracket and microphone connector, then tighten.
- ③ Adjust the angle for the clearest view of the function display.

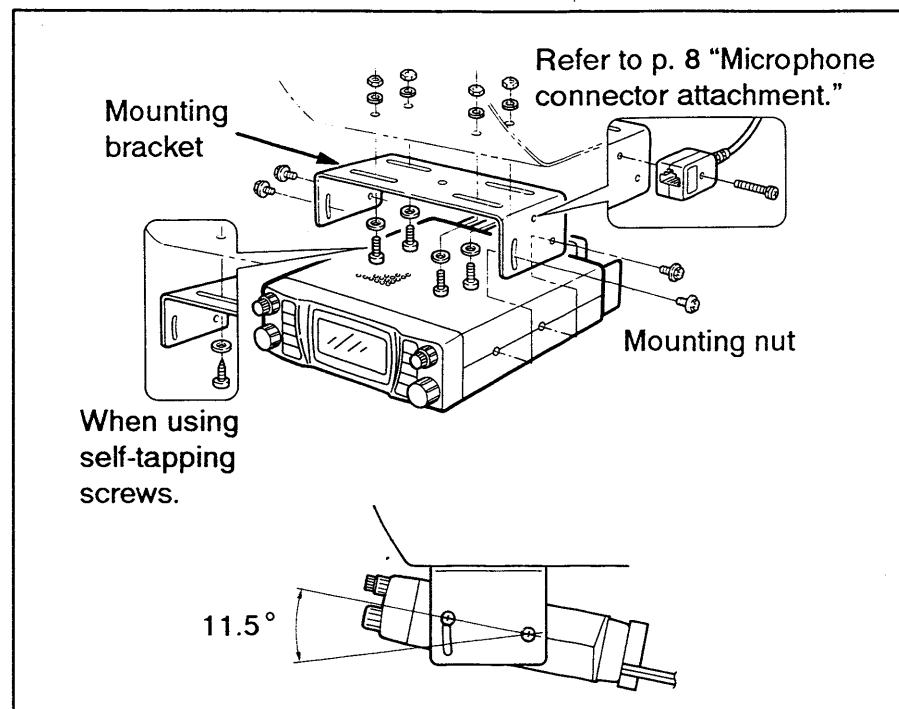

Microphone connector attachment

◇ Either side of the mounting bracket

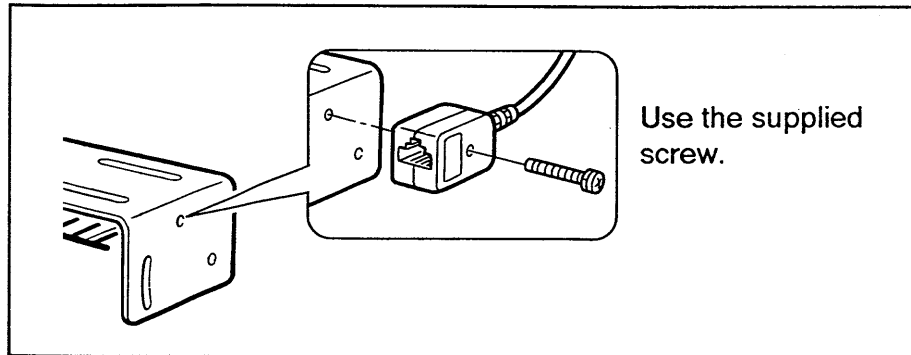

◇ Dashboard, etc.

Use the supplied Velcro tape.

Battery connection

NEVER connect the transceiver directly to a 24 V battery.

DO NOT use the cigarette lighter socket.

To prevent voltage drops, solder or crimp cable lugs when connecting the power cable to the battery.

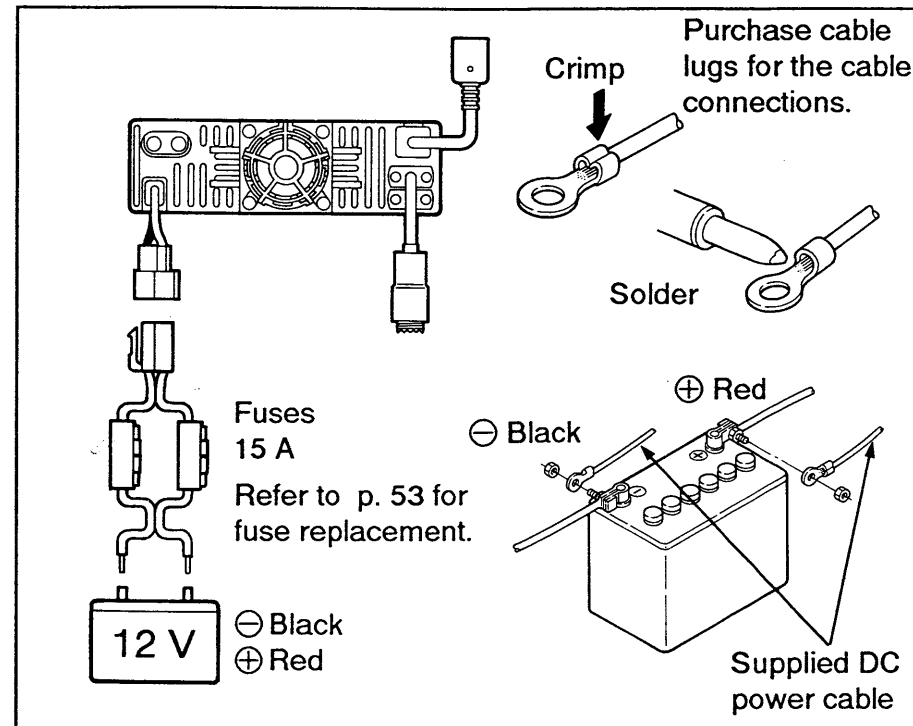

◇ DC power supply connection

Use a 13.8 V DC power supply with more than 11 A capability. Icom offers an optional IC-PS30 DC POWER SUPPLY.

Make sure the ground terminal of the DC power supply is grounded.

2 INSTALLATION

■ Antenna installation

◇ Antenna location

You can use a dual band antenna because the IC-2340H/A/E has a built-in duplexer.

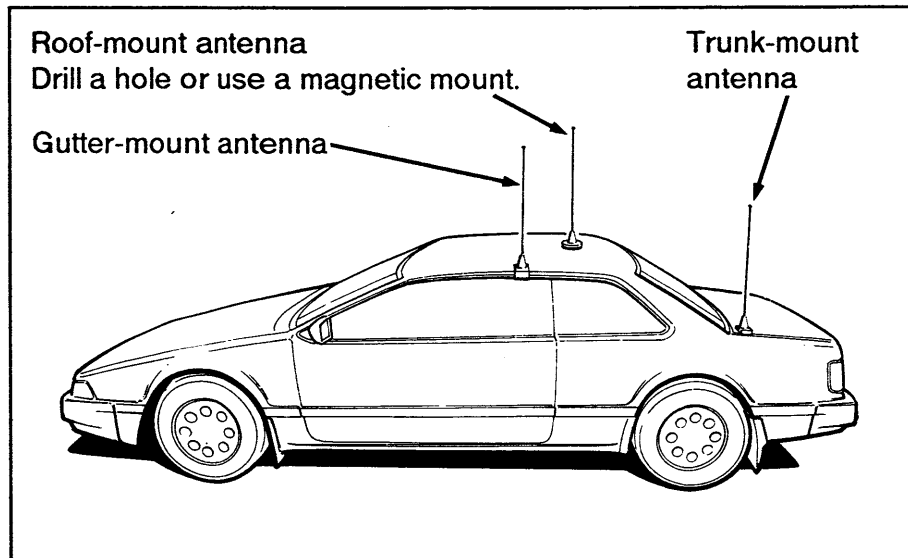

◇ Mono band antenna connection

An external duplexer must be connected when using a separate antenna for each band.

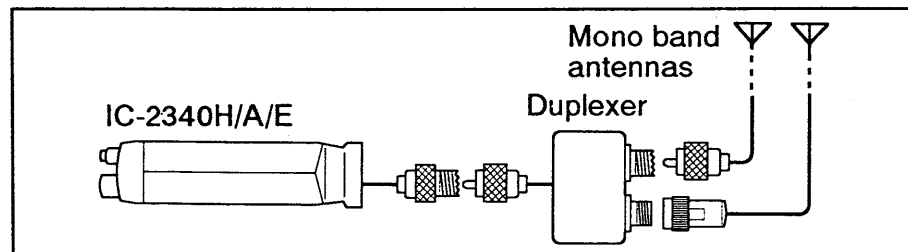

◇ Antenna connector

The antenna connector uses a PL-259-type connector.

- ① Slide the coupling ring over the coaxial cable.

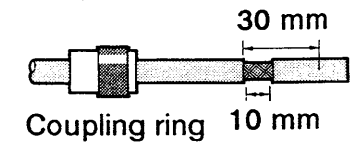

- ② Strip the cable, and soft solder the center conductor.

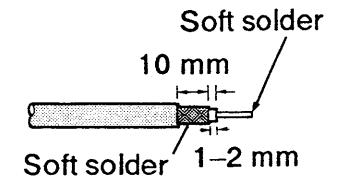

- ③ Slide the connector body onto the cable and solder.

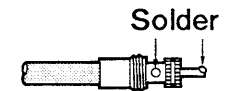

- ④ Screw the coupling ring onto the connector body.



30 mm \approx 9/8 in
10 mm \approx 3/8 in
1-2 mm \approx 1/16 in

Optional unit installation

Available optional units

<p>UT-55 DTMF ENCODER/ DECODER UNIT</p>	<ul style="list-style-type: none"> - Provides the pager and code squelch functions. (pgs. 33 – 36) - Provides external DTMF remote. (pgs. 43, 44) - When used with the HM-77/A DTMF MICROPHONE, provides mic DTMF remote. (pgs. 42, 44)
<p>UT-66 VOICE SYNTHESIZER UNIT</p>	<p>A clear, electronically-generated voice announces an operating frequency in English or Japanese. (p. 46)</p>
<p>UT-89 TONE SQUELCH UNIT</p>	<p>Provides the subaudible tone encoder, pocket beep and tone squelch functions. (pgs. 16, 31, 32)</p>

Installation procedure

- ① Turn the power OFF, then disconnect the DC power cable.
- ② Unscrew the 6 screws, then remove the top cover. (Fig. 1)
- ③ Install required optional units. (Fig. 2)
 - For the U.S.A. version, replace the built-in subaudible tone encoder unit with the UT-89.
- ④ Replace the top cover and screws.

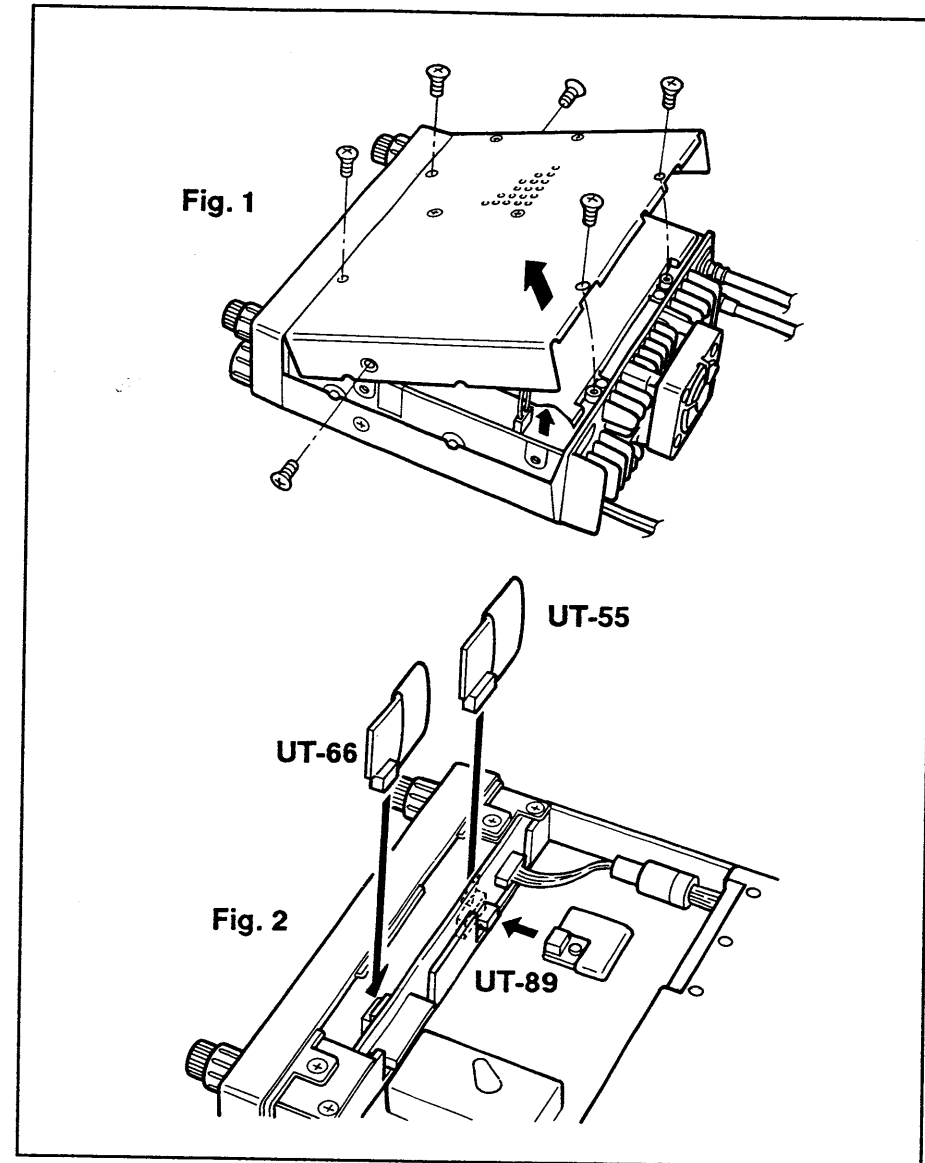

Pre-operation

Turning power ON/OFF

Push and hold [POWER] for 1 sec. to turn power ON or OFF.

Push and hold [POWER] for 1 sec.

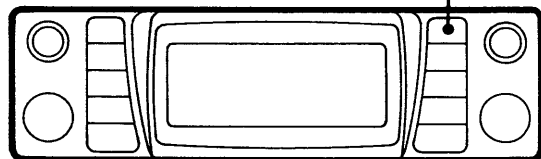

Convenient

If auto power-off is in use, the transceiver automatically turns the power OFF after a selected period in which no switches or tuning dials are operated. (p. 48)

MAIN band and SUB band

The IC-2430H/A/E has MAIN and SUB bands.

MAIN band	<ul style="list-style-type: none"> - Used for both transmitting and receiving. - All function selections for the band and frequency changing via the microphone are possible.
SUB band	<ul style="list-style-type: none"> - Used for receiving only. - Some function selections require the SUB band access. (p. 30)

MAIN band and VFO mode selections

① Push the desired band's tuning dial to assign the MAIN band.

- "MAIN" appears for the assigned band.

When the VHF band is assigned as the MAIN band.



② Select VFO mode with the selected band's [V/MHz].

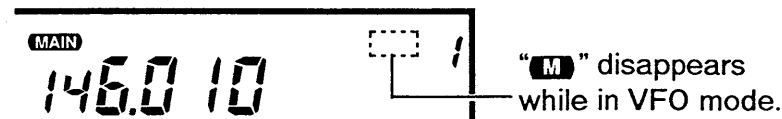

"M" disappears while in VFO mode.



If the 100 kHz and below digits disappear, push [V/MHz] again.

NOTE: DO NOT push and hold the tuning dial, since "SUB" appears instead of "MAIN." If "SUB" appears, push the tuning dial again to select the band as the MAIN band. (p. 30)

■ Using tuning dials

- ① Select VFO mode with the desired band's [V/MHz].
- ② Rotate the selected band's tuning dial.
 - Frequency changes according to the selected tuning steps. (p. 13)

◇ 1 MHz tuning step

Push the selected band's [V/MHz] to select 1 MHz tuning step. Push [V/MHz] again to return to previous tuning step.

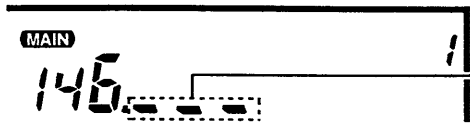

While 1 MHz tuning step is selected, the 100 kHz and below digits disappear.

◇ 10 MHz tuning step

Italy version	Available for both bands.
Asia version	Available for the VHF band only.

Push and hold the selected band's [V/MHz] to select 10 MHz tuning step. Push and hold [V/MHz] again to return to previous tuning step, or push [V/MHz] to select 1 MHz step.

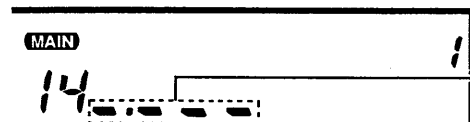

While 10 MHz tuning step is selected, the 10 MHz and below digits disappear.

■ Using [UP]/[DN] switches

Push [UP] or [DN] on the microphone to set the MAIN band's frequency.

- ① Select VFO mode with the desired band's [V/MHz].
- ② Push [UP] or [DN] to change the frequency.
 - Frequency changes according to the selected tuning steps. (p. 13)
 - Be sure [LOCK] on the microphone is in the "OFF" position.

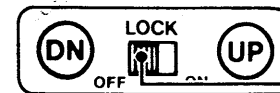

"OFF" position.

NOTE:

- **DO NOT** push and hold [UP] or [DN], since full scan or programmed scan may start. To cancel the scan, push [UP] or [DN] again. (p. 25)
- [UP] and [DN] cannot be used for frequency setting while:
 - Up switch remote is in use. (p. 37)
 - In remote standby condition. (p. 42, 43)
 - Mic DTMF remote or external DTMF remote is in use. (pgs. 42, 43)

3 FREQUENCY SETTING

Frequency lock function

To prevent accidental frequency changes and function access, this function electronically locks the tuning dials and switches.

Push and hold [SET•LOCK] to lock or unlock the tuning dials and controls.

Push and hold to lock or unlock.

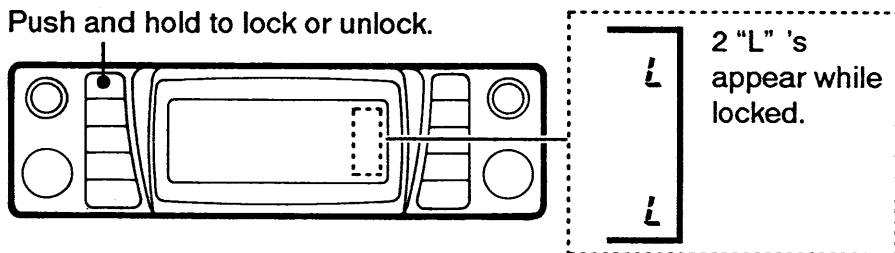

◇ Non-locked functions

Even while the operating frequencies are locked, the following functions are not locked:

- MAIN band selection
- [VOL•MONI]
- [SQL]
- PTT switch
- DTMF keyboard, [MW], [MR] and [RD] on the HM-77/A
- [TONE] on the HM-79

Tuning steps

SET mode

V/U Separate

Select a tuning step according to your area of operation.

- ① Push the desired band's tuning dial to assign the MAIN band.
- ② Select VFO mode with the selected band's [V/MHz].
- ③ Push [SET] several times until "dP" appears.
 - Refer to p. 50 for SET mode content details.
- ④ Rotate the selected band's tuning dial to select a tuning step.
 - 5, 10, 12.5, 15, 20, 25, 30 or 50 kHz steps are available.

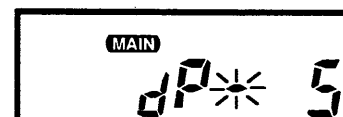

U.S.A. version, VHF band



U.S.A. version, UHF band

Initial setting

Version	VHF	UHF
U.S.A.	5 kHz	25 kHz
Korea	20 kHz	20 kHz
Australia	25 kHz	25 kHz
Asia	15 kHz	25 kHz
Europe Italy	25 kHz	25 kHz

- ⑤ Push either band's tuning dial to exit SET mode.

Receiving

The IC-2340H/A/E can receive VHF and UHF band signals simultaneously. Perform steps ① – ③ for each band.

- ① Push and hold [POWER] to turn the power ON.
- ② Set the desired band's squelch and audio levels.
 - Rotate [SQL] counterclockwise to open the squelch.
 - Rotate [VOL] to adjust the audio output level.
 - Rotate [SQL] clockwise until noise is just muted.
- ③ Select VFO mode with the desired band's [V/MHz].
- ④ Set the selected band's operating frequency. (p. 12)

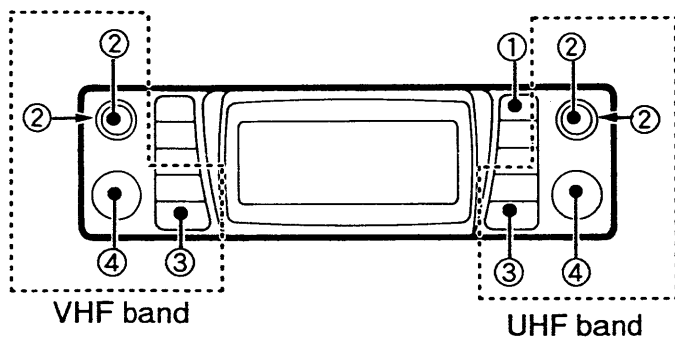

◇ When a signal is received

- The squelch opens and the speaker emits audio.
- "BUSY" appears.
- The S/R/F indicator shows the relative signal strength.



When receiving a signal on the VHF band.

◇ Monitor function

This function is used to listen to weak signals without disturbing the squelch level setting.

Push and hold the desired band's [VOL•MONI] to open the desired band's squelch.

◇ Mute function

This function mutes both the VHF and UHF bands' audio signals quickly without disturbing the volume settings.

- ① Push [MUTE] to mute both bands' audio signals

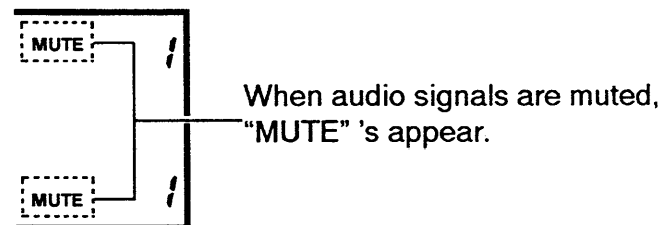

- ② Push [MUTE] again to cancel the function.

4 BASIC OPERATION

Transmitting

CAUTION: Transmitting without an antenna may damage the transceiver.

NOTE:

- To prevent interference, listen on the frequency before transmitting by pushing and holding the MAIN band's [VOL•MONI].
- To prevent howling and sensitivity reduction, **AVOID** setting the UHF band frequency near 3 times the VHF band frequency. E.g. setting for 145 MHz and 435 MHz.

- ① Push the desired band's tuning dial to assign the MAIN band for transmitting.
- ② Set the operating frequency. (p. 12)
- ③ If "DUP" or "DUP -" appears, push [DUP] 1 or 2 times until "DUP" or "DUP -" disappears to select simplex.
- ④ Push and hold [PTT] to transmit.
 - "Tx" appears and the S/RF indicator shows the output power selection.
- ⑤ Speak into the microphone using your normal voice level.
 - **DO NOT** hold the transceiver too close to your mouth or speak too loudly. This may distort the signal.
- ⑥ Release [PTT] to return to receive.

◇ Output power selection

The transceiver has 3 output power levels to suit your operating requirements.

- ① Push the desired band's tuning dial to assign the MAIN band.
- ② Push and hold [MUTE•LOW] several times to select an output power level.

◇ Selectable output power levels

	Low power indicator	S/RF indicator	Output power*	
			VHF	UHF
High	Disappears	■■■■■5■■■■9■■■■■	50 W (25 W)	35 W (25 W)
Low 2	"LOW ★"	■■■■■5	10 W	10 W
Low 1	"LOW"	■■■■	5 W (1 W)	5 W (1 W)

*Non-bracketed values are for the IC-2340H.
Bracketed values are for the IC-2340A/E.

◇ What are simplex and duplex?

Simplex	Used for normal communication. Simplex means transmitting and receiving on the same frequency.
Duplex	Used for communication via a repeater. Duplex means transmitting and receiving on different frequencies. (p. 16)

■ Accessing

A repeater receives signals and re-transmits them on a different frequency. Thus, longer communication distances are available. To access a repeater that requires a tone, refer to right.

- ① Push the desired band's tuning dial to assign the MAIN band for transmitting.
- ② Select VFO mode with the selected band's [V/MHz].
- ③ Set an offset frequency matched with the repeater, if required. (p. 17)
- ④ Set the repeater output frequency as your receive frequency.
- ⑤ Push [DUP] to select either "DUP" or "DUP -" offset direction.

Transmitting frequency shifts in higher direction

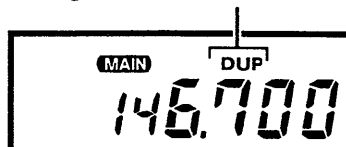

Transmitting frequency shifts in lower direction

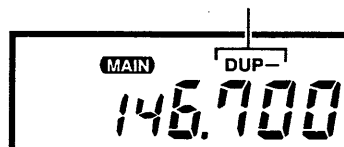

- ⑥ Push [PTT] to access the repeater.

◇ Monitor function during repeater operation

While pushing [VOL•MONI], the transceiver receives the repeater input frequency.

◇ Subaudible tones

The subaudible tone encoder function availability varies according to transceiver version:

U.S.A. version	The function is built-in.
Non-U.S.A. versions	A 88.5 Hz tone encoder is built-in. An optional UT-89 TONE SQUELCH UNIT is required for other frequencies. (p. 10)

- ① Select a subaudible tone frequency. (p. 17)
- ② Push and hold [DUP•TONE] 1 time.
 - "T" appears.
- ③ To cancel, push and hold [DUP•TONE].
 - The U.S.A. version: 1 time.
 - When an optional UT-89 is installed: 3 times.

◇ DTMF code (U.S.A. and Korea versions)

- ① Set [LOCK] on the HM-77/A DTMF MICROPHONE to the "OFF" position.
- ② Push desired keys on the DTMF keyboard.

◇ 1750 Hz tone call (Europe and Italy versions)

Push and hold [TONE] on the HM-79 HAND MICROPHONE for approx. 1 – 3 sec.

To transmit a 1750 Hz tone using an optional HM-77/A DTMF MICROPHONE, refer to p. 41.

5 REPEATER OPERATION

■ Tone frequency

SET mode

V/U Separate

Select a subaudible tone frequency that matches a repeater or another station. Non-U.S.A. versions do not have this setting without an optional tone unit.

- ① Push the desired band's tuning dial.
- ② Select VFO mode, a memory channel, etc., if required.
 - A subaudible tone frequency is independently programmable into a VFO or each channel.
- ③ Push [SET] several times until "T" blinks.
 - Refer to p. 50 for SET mode content details.
- ④ Rotate the selected band's tuning dial to set a subaudible tone frequency.

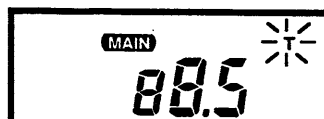

Initial setting

All versions, VHF/UHF bands:
88.5 Hz

- ⑤ Push either band's tuning dial to exit SET mode.

◇ Subaudible tone frequency list

67.0	82.5	100.0	123.0	151.4	186.2	233.6
69.3	85.4	103.5	127.3	156.7	192.8	241.8
71.9	88.5	107.2	131.8	162.2	203.5	250.3
74.4	91.5	110.9	136.5	167.9	210.7	
77.0	94.8	114.8	141.3	173.8	218.1	
79.7	97.4	118.8	146.2	179.9	225.7	

Unit: Hz

■ Offset frequency

SET mode

V/U Separate

The difference between the repeater input and output frequencies is called the offset frequency. Select an offset frequency that matches a repeater for each band.

- ① Push the desired band's tuning dial.
- ② Select VFO mode, a memory channel, etc., if required.
 - An offset frequency is independently programmable into a VFO or each channel.
- ③ Push [SET] several times until "DUP" blinks.
 - Refer to p. 50 for SET mode content details.
- ④ Rotate the selected band's tuning dial to set the offset frequency.
 - To select 1 MHz steps, push [V/MHz].

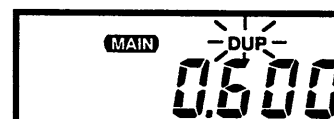

VHF band



U.S.A. version, UHF band

Initial setting

Version	VHF	UHF
U.S.A. Australia Asia	600 kHz	5 MHz
Korea		1 MHz
Europe Italy		7.6 MHz

- ⑤ Push either band's tuning dial to exit SET mode.

Auto repeater

INITIAL SET mode

U.S.A. version only

On the VHF band, when the operating frequency is within the repeater frequency range, this function activates repeater settings.

- ① Turn the power OFF.
- ② While pushing [SET], turn the power ON to enter INITIAL SET mode.

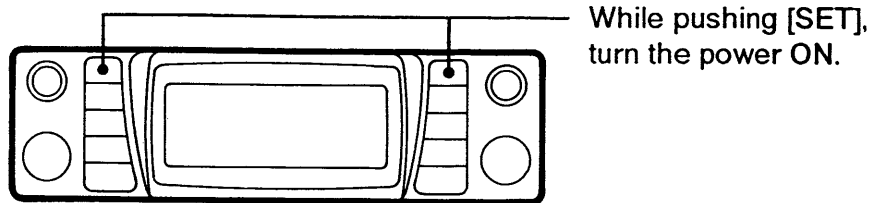

- ③ Push [SET] several times until "rPt" appears.
- ④ Rotate the VHF tuning dial to activate or cancel the auto repeater function.



"oF"	The auto repeater function is cancelled.
"r1"	Duplex is automatically activated within the repeater frequency range below.
"r2"	Duplex and the subaudible tone encoder are automatically activated within the repeater frequency range below.

- ⑤ Push and hold [POWER] to turn the power OFF to exit INITIAL SET mode.

◇ Frequency range and offset direction

VHF	145.200 – 145.495 MHz	"DUP –" appears.
	146.610 – 146.995 MHz	
	147.000 – 147.395 MHz	"DUP" appears.
UHF	442.000 – 444.995 MHz	"DUP" appears.
	447.000 – 449.995 MHz	"DUP –" appears.

6

MEMORY OPERATION

General description

Following channels are available for each band:

Memory channels 1 – 50	Used to memorize often-used frequencies with other required information.
Scan edge channels 1A, 1b	Used to specify scan edge frequencies for the programmed scan. (p. 25)

Channel arrangement during MEMORY mode

VHF band memory and scan edge channels

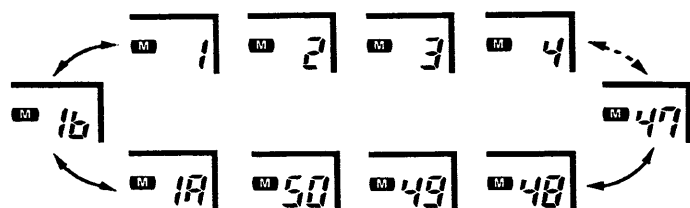

UHF band memory and scan edge channels

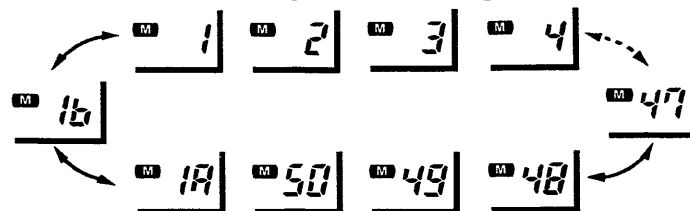

NOTE: “**SKIP**” appears when the selected memory channel is not programmed yet. When a new frequency is programmed, “**SKIP**” disappears. (p. 27)

Memory selection

- Push the desired band’s [M/CALL] 1 or 2 times until “**M**” appears to select MEMORY mode.
- Select a memory channel or scan edge channel in one of the following ways:
 - Rotate the selected band’s tuning dial.
 - Push [UP] or [DN] on the microphone.
 - Be sure [LOCK] on the microphone is in the “OFF” position.

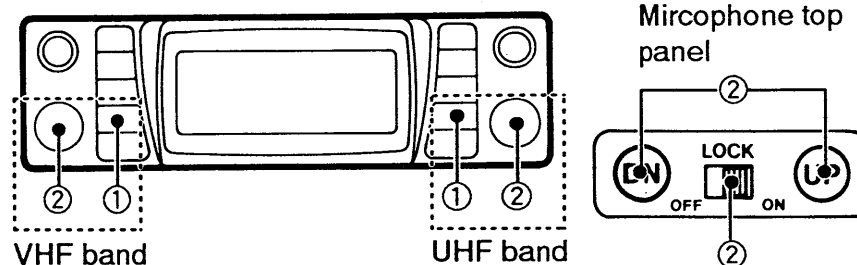

- To return to VFO mode, push the selected band’s [V/MHz].
 - “**M**” disappears.

NOTE: **DO NOT** push and hold [UP] or [DN], since memory scan may start. To cancel scanning, push [UP] or [DN] again. (p. 26)

Memory programming

- ① Push the desired band's tuning dial.
- ② Push the selected band's [M/CALL] 1 or 2 times until "M" appears to select MEMORY mode.
- ③ Select a memory channel or scan edge channel to be programmed.
- ④ Push the selected band's [V/MHz] to select VFO mode.
- ⑤ Select the desired frequency, etc. to be programmed.
- ⑥ Push and hold [SPCH•MW] to program.
 - 3 beeps may sound.
 - If [SPCH•MW] is continuously pushed and held, the memory channel number is automatically incremented for programming convenience.

◆ Programmable contents

- Operating frequency (p. 12)
- Duplex direction "DUP -" or "DUP" (p. 16)
- Offset frequency (p. 17)
- Subaudible tone frequency*¹ (p. 17)
- Subaudible tone encoder or tone squelch function*² (pgs. 16, 31)

*¹ An optional UT-89 TONE SQUELCH UNIT is required for non-U.S.A. versions.

*² An optional UT-89 TONE SQUELCH UNIT is required.

[Example] Programming 145.40 MHz into memory channel 15.

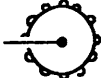
Push the VHF tuning control. 

Push  to select MEMORY mode.

Rotate the VHF tuning control to select memory channel 15. 

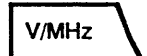
Push  to select VFO mode.

Rotate the VHF tuning control to select 145.40 MHz. 

Push and hold  to program.

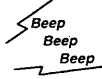
 3 beeps may sound.

Next memory channel number may appear.

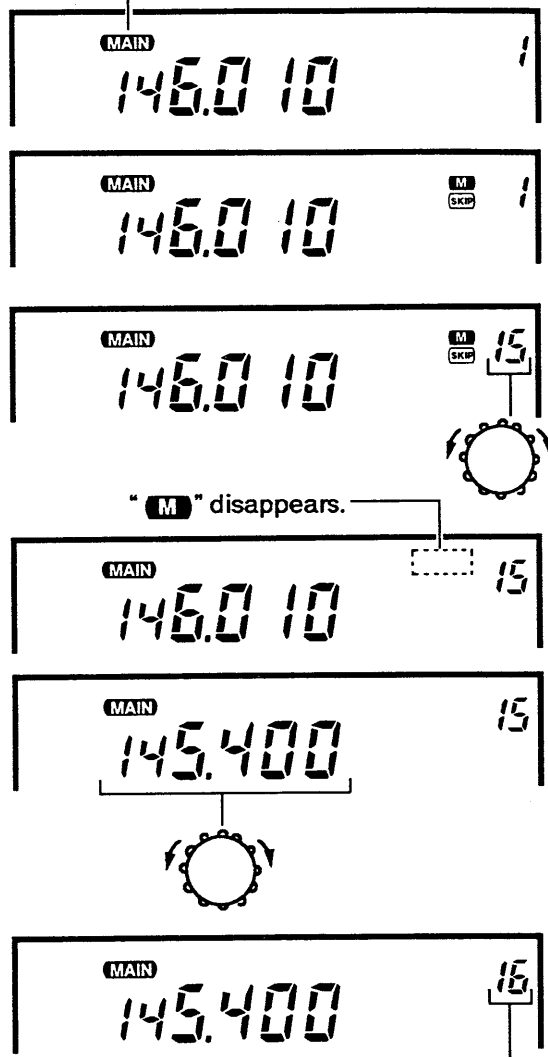

6 MEMORY OPERATION

Memory channel contents transferring

A memory channel or scan edge channel's contents can be transferred into a VFO.

- ① Push the desired band's tuning dial.
- ② Push the selected band's [M/CALL] 1 or 2 times until "M" appears to select MEMORY mode.
- ③ Rotate the selected band's tuning dial to select the memory channel or scan edge channel to be transferred.
- ④ Push and hold [SPCH•MW] to transfer.
 - 3 beeps may sound.
 - "M" disappears as VFO mode is automatically selected.

Convenient

This function is useful when searching for signals around a memory channel frequency, and for recalling the offset frequency, subaudible tone frequency, etc.

[Example] Transferring memory channel 15's contents into the VFO.

Push the VHF tuning control.  "MAIN" appears for the VHF band.



Push  to select MEMORY mode.

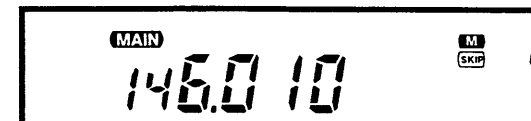

Rotate the VHF tuning control to select memory channel 15.

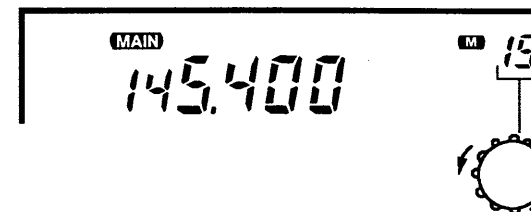

Push and hold  to transfer.

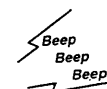
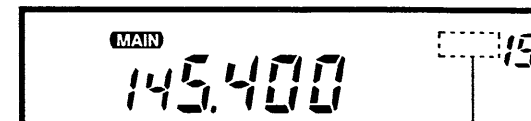

3 beeps may sound.

"M" disappears.

■ Call channel recalling

Each band has an independent call channel to store a most-often-used frequency for quick recall.

- ① Push the desired band's [M/CALL] 1 or 2 times until a large "C" appears to select a call channel.
 - To transmit on the call channel, push the desired band's tuning dial.

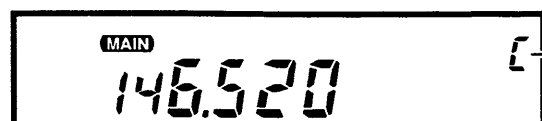

Large "C" appears when the call channel is recalled.

- ② To return to VFO mode, push the selected band's [V/MHz].
 - The large "C" changes to a small "c."

■ Call channel programming

- ① Push the desired band's tuning dial.
- ② Push the selected band's [M/CALL] 1 or 2 times until a large "C" appears.
- ③ Push the selected band's [V/MHz] to select VFO mode.
 - The large "C" changes to a small "c."
- ④ Select the frequency, etc. to be programmed.
 - Refer to "Programmable contents" at right.
- ⑤ Push and hold [SPCH•MW] to program.
 - 3 beeps may sound.

◇ Programmable contents

- Operating frequency (p. 12)
- Duplex direction "DUP -" or "DUP" (p. 16)
- Offset frequency (p. 17)
- Subaudible tone frequency*¹ (p. 17)
- Subaudible tone encoder or tone squelch function*² (pgs. 16, 31)

*¹ An optional UT-89 TONE SQUELCH UNIT is required for non-U.S.A. versions.

*² An optional UT-89 TONE SQUELCH UNIT is required .

■ Call channel contents transferring

A call channel's contents can be transferred into a VFO.

- ① Push the desired band's tuning dial.
- ② Push the selected band's [M/CALL] 1 or 2 times until large "C" appears.
- ③ Push and hold [SPCH•MW] to transfer.
 - 3 beeps may sound.
 - The large "C" changes to a small "c" as VFO mode is automatically selected.

What are scratch pad memories?

The transceiver automatically memorizes a frequency into a scratch pad memory when transmitting. Each band has the following scratch pad memories:

Duplex scratch pad memory	Automatically memorizes duplex operating frequency with a duplex setting.
Simplex scratch pad memory	Automatically memorizes simplex operating frequency .

Scratch pad recalling

- Push the desired band's [M/CALL] 1 or 2 times until a large "C" appears to select a call channel.
- Recall a scratch pad memory as follows:

Duplex scratch pad memory	Rotate the selected band's tuning dial clockwise or push [UP] on the microphone.
Simplex scratch pad memory	Rotate the selected band's tuning dial counterclockwise or push [DN] on the microphone.

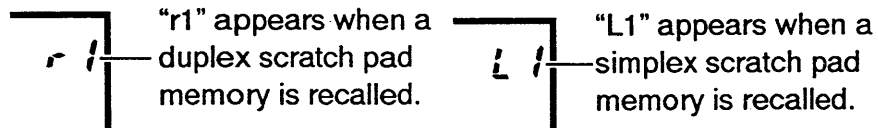

- To return to VFO mode, push the selected band's [V/MHz].
 - "r1" or "L1" changes to a small "c."

Stored contents

- Operating frequency (p. 12)
- Subaudible tone frequency*¹ (p. 17)
- Subaudible tone encoder or tone squelch function*² (pgs. 16, 31)
- Duplex direction "DUP -" or "DUP" for duplex scratch pad memories (p. 16)
- Offset frequency for duplex scratch pad memories (p. 16)

*¹ An optional UT-89 TONE SQUELCH UNIT is required for non-U.S.A. versions.

*² An optional UT-89 TONE SQUELCH UNIT is required.

Scratch pad contents transferring

A scratch pad's contents can be transferred into the VFO.

- Push the desired band's tuning dial.
- Recall a desired scratch pad memory.
- Push and hold [SPCH•MW] to transfer.
 - 3 beeps may sound.
 - "r1" or "L1" changes to a small "c" as VFO mode is automatically selected.

Scan types

Scanning searches for transmitted signals automatically and makes it easier to locate new stations for contact or listening purposes.

Each band has 3 scan types and 5 resume conditions to suit your needs. Scans on the 2 bands can be operated individually or simultaneously.

Full scan (p. 25)

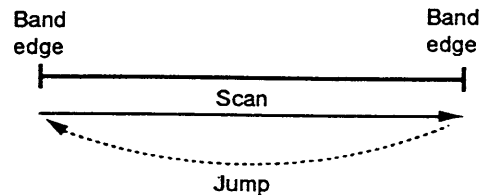

Repeatedly scans all frequencies over the entire selected band. Used as the simplest scan without any presetting.

Programmed scan (p. 25)

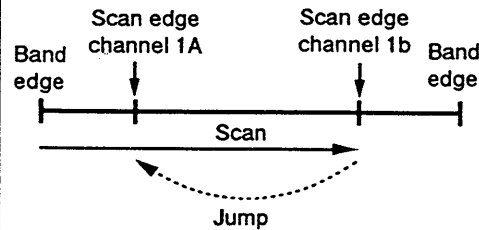

Repeatedly scans between specified scan edge frequencies. Used for checking within a frequency range such as repeater output frequencies, etc.

Memory scan (p. 26)

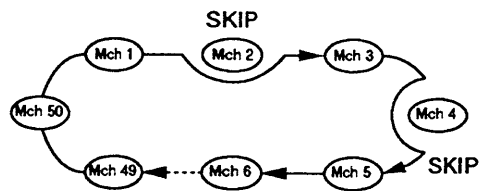

Repeatedly scans memory channels except skip channels. Used for checking often-called channels. Normally-busy channels such as repeater frequencies can be skipped.

Scan resume condition (p. 27)

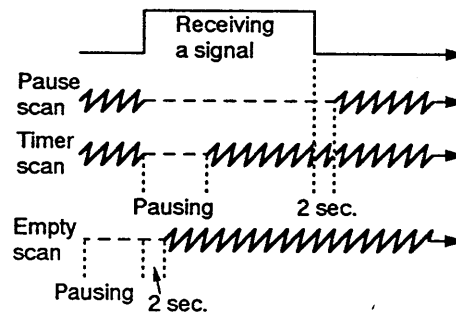

5 resume conditions are available.

- Pause scan: When receiving a signal, pauses until the signal disappears
- 3 timer scans: When receiving a signal, pause for 5, 10 or 15 sec.
- Empty scan: Pauses until a signal appears.

9 SCAN OPERATION

■ Full scan and programmed scan

- ① Select full scan or programmed scan as at right.
- ② Push the desired band's tuning dial.
- ③ For the programmed scan, program different frequencies into scan edge channels 1A and 1b as at right.
- ④ Select VFO mode with the selected band's [V/MHz].
- ⑤ Push and hold [UP] or [DN] on the microphone, or [DTMF•SCAN] to start scanning.
 - Frequency changes according to selected tuning step.
 - To change the scanning direction, rotate the scanning band's tuning dial.

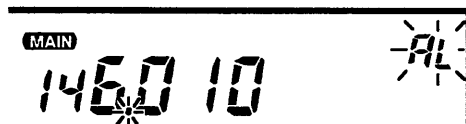

"AL" and decimal point blink during full scan.



"P1" and decimal point blink during programmed scan.

- ⑥ To cancel scanning, push [UP], [DN] or [DTMF•SCAN] again.

NOTE: While in the up switch remote or remote standby condition, push [DN] on the microphone to start the scan. (pgs. 37, 42)

◇ Full/programmed scan selection SET mode

V/U Separate

- ① Push the desired band's tuning dial.
- ② Select VFO mode with the selected band's [V/MHz].
- ③ Push [SET] several times until "PSC" appears.
 - Refer to p. 50 for SET mode content details.
- ④ Rotate the selected band's tuning dial to select full scan or programmed scan.

	Initial setting	"PSC-AL"
	"PSC-AL"	Full scan
	"PSC-1A 1b"	Programmed scan

- ⑤ Push either band's tuning dial to exit SET mode.

◇ Scan edge channel programming

- ① Push the desired band's tuning dial.
- ② Push the selected band's [M/CALL] 1 or 2 times until "M" appears to select MEMORY mode.
- ③ Select scan edge channel 1A.
- ④ Select VFO mode with the selected band's [V/MHz].
- ⑤ Select a scan edge frequency to be programmed.
- ⑥ Push and hold [SPCH•MW] until "1b" appears to program scan edge channel 1A.
- ⑦ Select another scan edge frequency to be programmed.
- ⑧ Push and hold [SPCH•MW] to program scan edge channel 1b.

■ Memory scan

- ① Program more than 2 memory channels in advance. (p. 20)
- ② Push the desired band's tuning dial.
- ③ Push the selected band's [M/CALL] 1 or 2 times until "M" appears to select MEMORY mode.
- ④ Push and hold [UP] or [DN] on the microphone, or [DTMF•SCAN] to start scanning.
 - To change the scanning direction, rotate the scanning band's tuning dial.



"M" and decimal point blink during memory scan.

- ⑤ To cancel scanning, push [UP], [DN] or [DTMF•SCAN] again.

NOTE:

- With initial setting before shipping, memory scan does not start, since all memory channels are programmed as skip channels. (p. 27)
- To speedup the memory scan interval, specify skip channels, if required. (p. 27)
- While in the up switch remote or remote standby condition, push [DN] on the microphone to start the scan. (pgs. 37, 42)

◇ When a signal is received

- Scan pauses on the frequency, then scan resumes 15 sec. after the signal disappears. The scan resume condition can be changed, if required. (p. 27)
- To resume the scan manually, rotate the scanning band's tuning dial.

◇ Scanning on the SUB band

When a new MAIN band is selected, scanning continues on the new SUB band. To cancel scanning on the SUB band, push the SUB band's tuning dial in advance.

9 SCAN OPERATION

◇ Skip channel setting

SET mode

Memory channels that you do not wish to scan can be specified as skip channels. This is convenient to speedup the memory scan interval.

- ① Push the desired band's tuning dial.
- ② Push the selected band's [M/CALL] several times until "M" appears to select MEMORY mode.
- ③ Rotate the selected band's tuning dial to select a memory channel to be set.
- ④ Push [SET] several times until "CHS" appears.
 - Refer to p. 50 for SET mode content details.
- ⑤ Rotate the selected band's tuning dial to set the memory channel as a skip channel or non-skip channel.

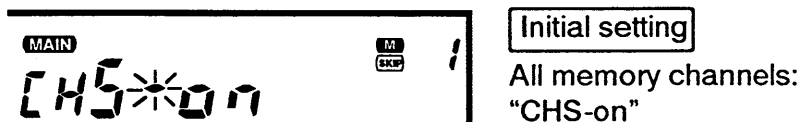

"CHS-on"	Skip channel. "SKIP" appears.
"CHS-oF"	Non-skip channel. "SKIP" disappears.

- ⑥ Push either band's tuning dial to exit SET mode.

NOTE: When a memory channel is programmed, the memory channel is automatically set as a non-skip channel.

◇ Scan resume condition

SET mode

V/U Separate

The scan resume condition can be selected.

- ① Push the desired band's tuning dial.
- ② Push [SET] several times until "Sct" or "SCP" appears.
 - Refer to p. 50 for SET mode content details.
- ③ Rotate the selected band's tuning dial to select a scan resume condition.

<p>MAIN Sct*15</p> <p>Initial setting Both VHF/UHF bands: "Sct-15"</p>	
"Sct-05," "Sct-10" or "Sct-15"	When receiving a signal, scan pauses, then resumes 5, 10 or 15 sec. after that.
"SCP-02"	Scan pauses until the signal disappears and then resumes 2 sec. after that.
"Sct-EP"	Scan pauses on non-busy channels. When receiving a signal, scan resumes 2 sec. after that.

- ④ Push either band's tuning dial to exit SET mode.

Priority watch types

The priority watch checks for signals on a memory or call channel every 5 sec. while operating on a VFO frequency.

The transceiver has 3 priority watch types to suit your needs. The priority watch operates on the 2 bands separately or simultaneously.

Memory channel watch (p. 29)

While operating on a VFO frequency, priority watch checks for a signal on the selected memory channel every 5 sec.

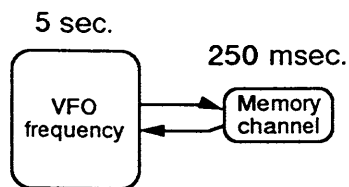

Call channel watch (p. 29)

While operating on a VFO frequency, priority watch checks for a signal on the call channel every 5 sec.

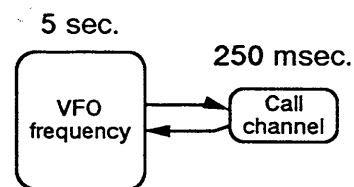

Memory scan watch (p. 29)

While operating on a VFO frequency, priority watch checks for signals on each memory channel in sequence.

- Skip channels are skipped. (p. 27)

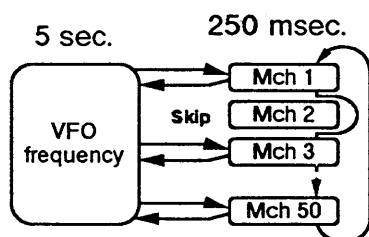

Scan resume condition (p. 27)

5 resume conditions are available.

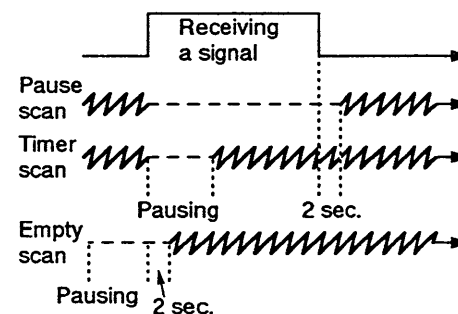

Priority watch operation

- ① Select VFO mode with the desired band's [V/MHz].
- ② Set an operating frequency.
- ③ Set the watching channel(s):

Memory channel watch	<ol style="list-style-type: none"> ① Push the selected band's [M/CALL] 1 or 2 times until "M" appears. ② Rotate the selected band's tuning dial to select a memory channel.
Memory scan watch	<ol style="list-style-type: none"> ① Push the selected band's [M/CALL] 1 or 2 times until "M" appears. ② Push and hold [DTMF•SCAN] to start the memory scan.
Call channel watch	Push the selected band's [M/CALL] 1 or 2 times until a large "C" appears.

- ④ Push and hold the selected band's [M/CALL•PRIO] to start the priority watch.
 - "PRIO" appears.

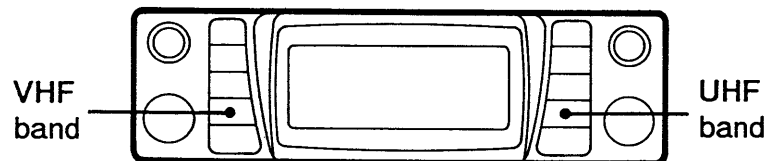

- ⑤ To cancel the priority watch, push the watching band's [M/CALL•PRIO] while the VFO frequency appears.

- NOTE:** When the priority watch starts:
- The optional pager and code squelch functions are cancelled.
 - The optional pocket beep function is automatically changed to the tone squelch function.

◇ While priority watch operates

- The transceiver checks a memory or call channel frequency every 5 sec.
- You can transmit on the VFO frequency while the priority watch operates.

◇ When a signal is received on a watching channel

- "PRIO" blinks.
- The priority watch resumes according to the selected scan resume condition. (p. 27)
- When "SCt-EP" is selected for the scan resume condition, the priority watch pauses on a non-busy channel.
- To resume the priority watch manually, push the selected band's [M/CALL•PRIO].

■ SUB band access

This function allows you to access most of the SUB band's functions and settings without exchanging the MAIN and SUB bands.

- ① Push and hold the SUB band's tuning dial until "SUB" appears to access the SUB band.

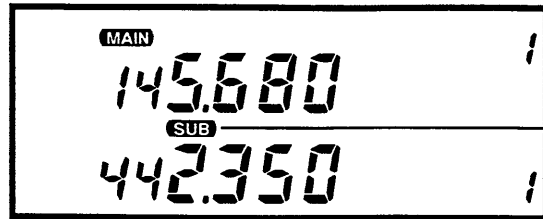

"SUB" appears while the SUB band is accessed.

- ② Push the desired switch to control the SUB band.
- ③ Cancel SUB band access in one of the following ways:
 - Push the MAIN band's tuning dial.
 - Push and hold the SUB band's tuning dial.
 - To select the current SUB band as the new MAIN band, push the SUB band's tuning dial.
 - "SUB" disappears.

NOTE: Even while the SUB band is accessed:

- Optional pager and code squelch functions operate for the MAIN band.
- The MAIN band still functions for receiving and transmitting.

■ SUB band mute/SUB band busy beep SET mode

V/U Common

These functions allow you the following:

SUB band mute	Automatically mutes SUB band audio signals when the MAIN and SUB bands' signals are simultaneously received. While the SUB band is muted, "MUTE" appears for the SUB band.
SUB band busy beep	A beep tone sounds to inform you that the SUB band's squelch closes. This beep tone means that a signal is received on the SUB band.

- ① Push [SET] several times until "Sub" appears.
 - Refer to p. 50 for SET mode content details.
- ② Rotate the MAIN band's tuning dial to set the condition.



	SUB band mute	SUB band busy beep
"Sub-oF"	Cancelled	Cancelled
"Sub-oF ((•))"	Cancelled	Activated
"Sub-on"	Activated	Cancelled
"Sub-on ((•))"	Activated	Activated

- ③ Push either band's tuning dial to exit SET mode.

■ Function availability

For pocket beep, tone squelch and tone scan operations, install an optional UT-89 TONE SQUELCH UNIT. (p. 10)

◇ Through a repeater

The pocket beep and tone squelch functions may not be effective through some repeaters that filter out subaudible tone frequencies.

■ Pocket beep operation

This function uses a subaudible tone frequency, and alerts you when a call from group members is received.

◇ Waiting for a call from another station

- ① Push the desired band's tuning dial.
- ② Set the operating frequency.
- ③ If "C SQL" or "PGR" appears, push [DTMF] 1 or 2 times to cancel them.
- ④ Set the subaudible tone frequency. (p. 17)
- ⑤ Push and hold [DUP•TONE] several times until "T SQL ((•))" appears.
- ⑥ When a matched tone frequency is received, beep tones sound for 30 sec. and "((•))" blinks.
- ⑦ Push [PTT] to answer or push the selected band's tuning dial to stop the beeps and "((•))" blinking.

- "T SQL" appears as the tone squelch function is automatically selected.

- ⑧ Push and hold [DUP•TONE] to cancel the tone squelch function.

- "T SQL" disappears.

◇ Calling a waiting station

Select a transmit tone frequency matched with the waiting station. Use the tone squelch function below.

■ Tone squelch operation

This function allows you to silently wait for a call from group members that use the same subaudible tone frequency.

- ① Push the desired band's tuning dial.
- ② Set the operating frequency.
- ③ Set the subaudible tone frequency. (p. 17)
- ④ Push and hold [DUP•TONE] several times until "T SQL" appears.
- ⑤ Operate the transceiver in the normal way.
 - Before calling, push and hold the selected band's [VOL•MONI] to listen on the frequency.
- ⑥ When a matched tone is received, the squelch opens and the speaker emits audio.
- ⑦ To cancel the tone squelch, push and hold [DUP•TONE].
 - "T SQL" disappears.

■ Tone scan operation

This function detects the subaudible tone frequency in a received signal. This is convenient for detecting a required tone frequency for repeater access, etc.

- ① Push the desired band's tuning dial.
- ② Set the desired operating frequency to be checked.
 - For a repeater, set to repeater input frequency.
- ③ Push and hold [DUP•TONE] several times until "T SQL" appears.
- ④ Push and hold [DTMF•SCAN] to start the tone scan.
- ⑤ To cancel the tone scan, push [DTMF•SCAN].

NOTE:

- This function operates while in VFO mode and while any channel is selected.
- When an optional pager or code squelch function is in use, the pager or code squelch function is automatically cancelled.
- When an optional pocket beep function is in use, the tone squelch function is automatically selected.
- To change the scanning direction, rotate the selected band's tuning dial.

◇ When the tone frequency is matched

- The tone scan pauses.
- The squelch opens.
- The detected subaudible tone frequency is automatically set into the currently selected VFO or a channel.
- The tone scan resumes according to the selected scan resume condition. (p. 27)

◇ Repeater accessing

Some repeaters require subaudible tone for access. By receiving another station's signal on a repeater input frequency, you can automatically set the required tone frequency.

- ① Set the repeater input frequency.
- ② Start the tone scan as at left.
- ③ Set to the repeater output frequency.
- ④ Set an offset frequency matched with the repeater, if required. (p. 17)
- ⑤ Push [DUP] to select either "DUP -" or "DUP" offset direction.
- ⑥ Push and hold [DUP•TONE] 2 times to activate the subaudible tone encoder.
 - "T" appears.
- ⑦ Push [PTT] to access the repeater.

Function availability

For pager and code squelch operations, install an optional UT-55 DTMF ENCODER/DECODER UNIT. (p. 10)

◇ With other functions

Subaudible tone encoder or tone squelch	The pager or code squelch can be activated simultaneously.
Pocket beep	When the pager or code squelch is activated, the tone squelch function is automatically selected.

What is pager?

This function uses DTMF codes for paging and can be used as a "message pager" to inform you of a caller's identity even if you leave the transceiver temporarily unattended.

Personal calls and group calls are available. Personal calls use the receiving parties' ID code for calling. The receiving parties' display shows your ID code and other stations in the party know that you called. You can also call all stations in your group using the group call.

Pager simulation 1: Personal call

When pager code "111 ✱ 000" is transmitted.

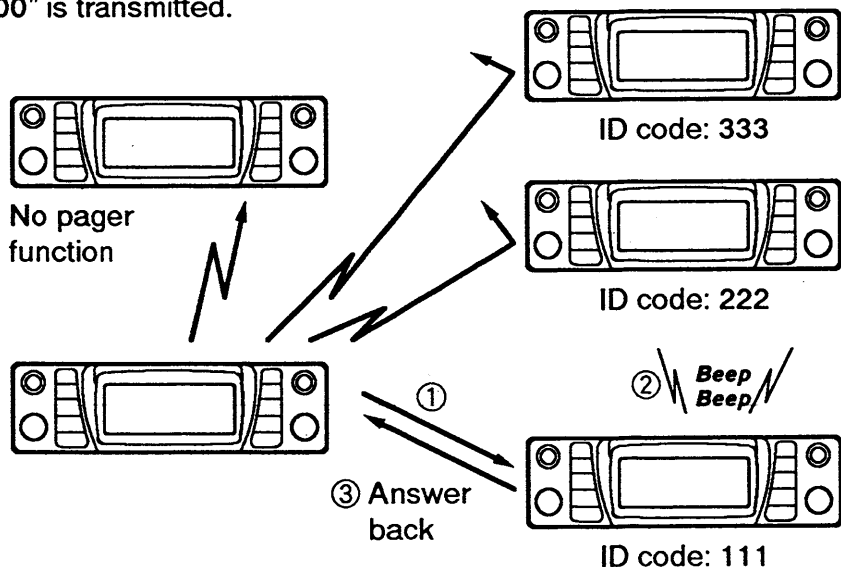

Pager simulation 2: Group call

When pager code "555 ✱ 000" is transmitted.

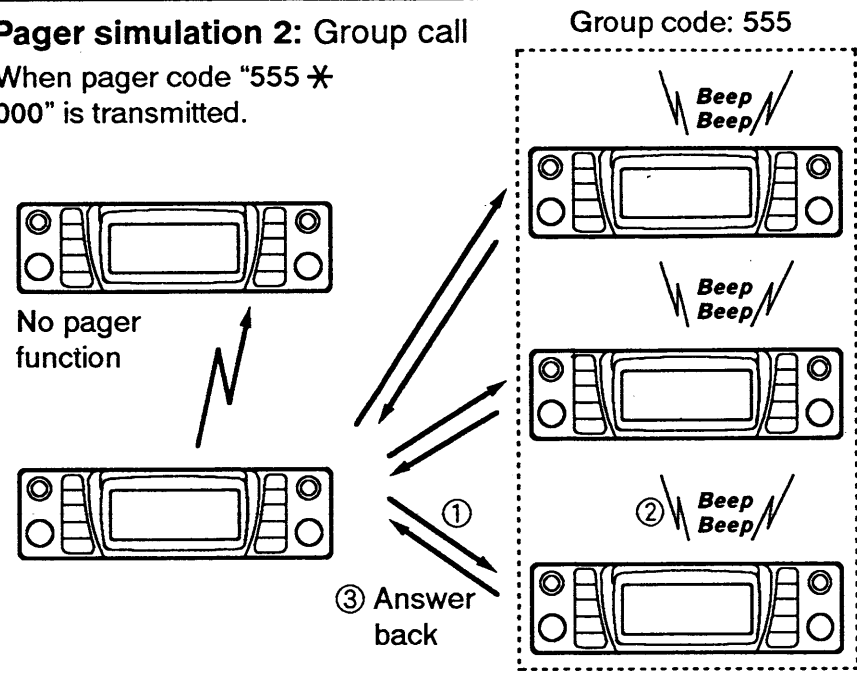

Code channel

◇ Before programming

The pager and code squelch functions require ID codes and a group code. These codes are 3-digit DTMF codes and must be programmed into the code channels before operation. These code channels are common for both bands.

◇ Code channel assignment

ID or group code	Code channel	"Receive accept" or "receive inhibit"
Your ID code	0	"Receive accept" only.
Other parties' ID code	1-5	"Receive inhibit" should be programmed in each channel.
Group code	One of 1-5	"Receive accept" must be programmed.
Memory space*	P	"Receive inhibit" only.

* Code channel P automatically memorizes an ID code when receiving a pager call. The contents in code channel P cannot be changed manually.

◇ Receive accept or receive inhibit

Code channels C1-C5 should be effectively set as "receive accept" or "receive inhibit":

Receive accept	<p>"SKIP" disappears. Accepts pager calls when the transceiver receives a signal with a code the same as that in the code channel.</p> <p>The code channel that stores a group code should be programmed as "receive accept." If the code channel is programmed as "receive inhibit," you cannot receive group calls.</p>
Receive inhibit	<p>"SKIP" appears. Rejects calls even when the transceiver receives a signal with a code the same as that in the code channel.</p> <p>The code channels that store other parties' ID codes for transmit codes should be programmed as "receive inhibit." If the channels are programmed as "receive accept," personal calls for parties other than yourself are received.</p>

Refer to p. 35 "Code programming" for "receive accept" and "receive inhibit" settings.

13 PAGER AND CODE SQUELCH

■ Code programming V/U Common

- ① Push [DTMF] several times until “PGR” or “C SQL” appears.
- ② Push [SET] several times until the code channel number blinks.



- ③ Rotate the selected band's tuning dial to select the desired code channel, 0–5.
 - Code channel P cannot be programmed.
- ④ Push [SET] or [SPCH] to select a digit to be programmed.
- ⑤ Rotate the selected band's tuning dial to set the digit.
- ⑥ Repeat steps ④ and ⑤ until all digits are programmed.
- ⑦ Push [DTMF] to set the code channel for “receive inhibit” or “receive accept.” (p. 34)
 - When “receive inhibit” is set, “**SKIP**” appears.
 - Code channel 0 cannot be set as “receive inhibit.”

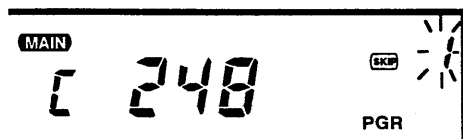

When code channel 1 is programmed for “248” and “receive inhibit.”

- ⑧ Push either band's tuning dial to exit the setting display.

■ Pager operation

◇ Calling a specific station

- ① Push the desired band's tuning dial.
- ② Set the operating frequency.
- ③ Push [DTMF] several times until “PGR” appears.
- ④ Select the desired code channel:
 - Push [SET] several times until the code channel number blinks.
 - Rotate the selected band's tuning dial to select the code channel.
 - Push either band's tuning dial to exit the setting display.
- ⑤ Push [PTT] to transmit the pager code.
 - Before calling, push and hold the selected band's [VOL•MONI] to listen on the frequency.
- ⑥ Wait for an answer back.
 - When an answer back code is received, the other party's ID or group code appears and the transceiver beeps. (p. 33)
- ⑦ After confirming a connection, push either band's tuning dial to display the operating frequency.
- ⑧ Push [DTMF] 1 time to select code squelch or 3 times to select the non-selective calling system.
 - During code squelch operation, “C SQL” appears. (p. 36)

◇ Waiting for a call from a specific station

- ① Push the desired band's tuning dial.
- ② Set the operating frequency.
- ③ Push [DTMF] several times until "PGR" appears.
- ④ Wait for a call.
- ⑤ Push [PTT] to send an answer back call and display the operating frequency.
- ⑥ Push [DTMF] 1 time to select code squelch or 3 times to select the non-selective calling system.

◇ When receiving a call

- 3 beep tones sound.
- The calling station's ID code or group code appears.
- "PGR" and the code channel number blink.

Personal calls

When you are called with your ID code and the calling station's ID code is "386."

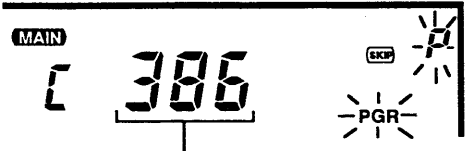

The diagram shows a radio display with a 'MAIN' indicator on the left and a 'PGR' indicator on the right. The central display shows the number '386'. A bracket is drawn under the number '386' with a line pointing to the text 'The calling station's ID code appears.' below it.

The calling station's ID code appears.

Group calls

When you are called with the group code "123," and "123" is programmed into code channel 5.

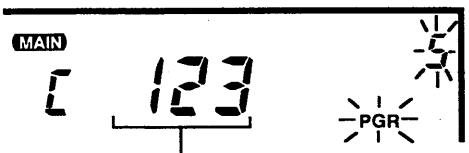

The diagram shows a radio display with a 'MAIN' indicator on the left and a 'PGR' indicator on the right. The central display shows the number '123'. A bracket is drawn under the number '123' with a line pointing to the text 'The group code appears.' below it.

The group code appears.

■ What is code squelch?

The code squelch function provides communication with silent standby, since the transceiver only receives calls from stations which know your ID or group code. Prior to voice transmission, a 3-digit code is transmitted to open the receiving station's code squelch.

■ Code squelch operation

- ① Push the desired band's tuning dial.
- ② Set the operating frequency.
- ③ Push [DTMF] several times until "C SQL" appears.
- ④ Select the desired code channel.
 - Push [SET] several times until the code channel number blinks.
 - Rotate the selected band's tuning dial to select the code channel.
 - Push either band's tuning dial to exit the setting display.
- ⑤ Operate the transceiver in the normal way.
 - Before calling, push and hold the desired band's [VOL•MONI] to listen on the frequency.
- ⑥ Push [DTMF] 2 times to select the non-selective calling system.

14 UP SWITCH REMOTE

What is up switch remote?

By allocating your most-used switch's function to [UP] on the microphone, you can remotely access the function without stretching your arm.

Up switch remote programming

- ① Turn the power OFF.
- ② Set [LOCK] on the microphone to the "OFF" position.

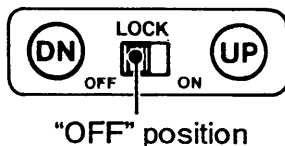

- ③ While pushing [UP] and the desired switch or control, turn the power ON.
 - Both primary and secondary functions for a switch are allocated to [UP].

Programmable switches and controls

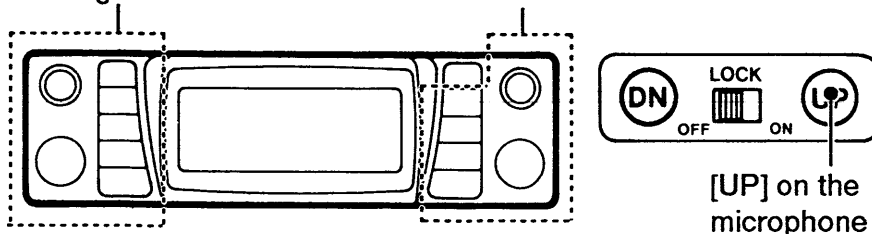

Up switch remote operation

When [UP] is pushed.	Primary function is activated.
When [UP] is pushed and held.	Secondary function is activated.

[Example]

If [MUTE•LOW] is programmed:

When [UP] is pushed.	Mutes both band's audio signals.
When [UP] is pushed and held.	Selects the MAIN band's output power.

- NOTE:** While the up switch remote is in use:
- [UP] and [DN] cannot be used for frequency setting.
 - [UP] cannot be used to start a scan.
 - Push [DN] or push and hold [DTMF•SCAN] to start and cancel a scan.
 - Rotate the scanning band's tuning dial to change the scanning direction.

Up switch remote cancelling

- ① Turn the power OFF.
- ② Set [LOCK] on the microphone to the "OFF" position.
- ③ While pushing [UP], turn the power ON.

■ General description

The HM-77/A DTMF MICROPHONE is equipped with 14 DTMF memory channels and a re-dialing function for auto dialing. Up to a 22-digit code can be memorized into each DTMF memory channel.

NOTE:

- The HM-77/A is optional for non-U.S.A. and non-Korea versions.
- When used with an optional UT-55 DTMF ENCODER/DECODER UNIT, the HM-77/A also provides mic DTMF remote. (pgs. 42, 44)

◇ Mode types

The HM-77/A has 4 different modes:

Normal mode	A DTMF code is transmitted when a [1]– [0], [A]– [D], [*] or [#] key is pushed.
Memory write mode	Used when writing DTMF codes into a DTMF memory channel. The active indicator rapidly blinks.
Memory read mode	Used when reading DTMF codes from a DTMF memory channel. The active indicator continuously lights.
Re-dial mode	Used when recalling the last-transmitted DTMF code. The active indicator slowly blinks.

■ DTMF memory operation

◇ DTMF memory writing

- ① Push [MW] on the microphone to select the memory write mode.
 - The active indicator blinks rapidly.
- ② Push and hold the PTT switch until step ⑤.
- ③ Push the desired DTMF memory channel number, [0]–[9] or [A]–[D].
 - The active indicator goes out.
- ④ Push the desired DTMF digits to be programmed while continuing to push the PTT switch.
 - Up to 22 digits can be programmed.
- ⑤ Release the PTT switch.
 - The active indicator rapidly blinks.
- ⑥ Push [MW] to return to the normal mode.
 - The active indicator goes out.

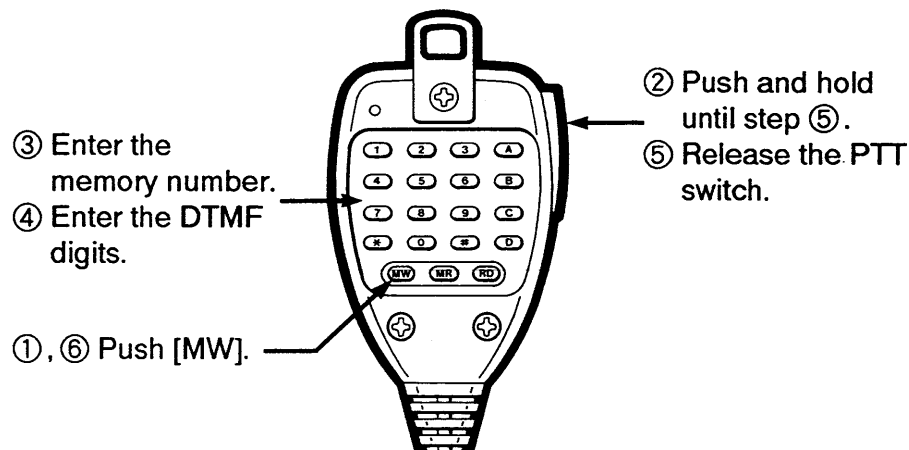

15 HM-77/A ADVANCED FUNCTIONS

◇ DTMF memory transmitting

- ① Push [MR] to select the memory read mode.
 - The active indicator lights.
- ② Push the desired DTMF memory channel number, [0]–[9] or [A]–[D], to transmit the memorized DTMF code.
 - The active indicator blinks while transmitting.
- ③ Push [MR] to return to the normal mode.
 - The active indicator goes out.

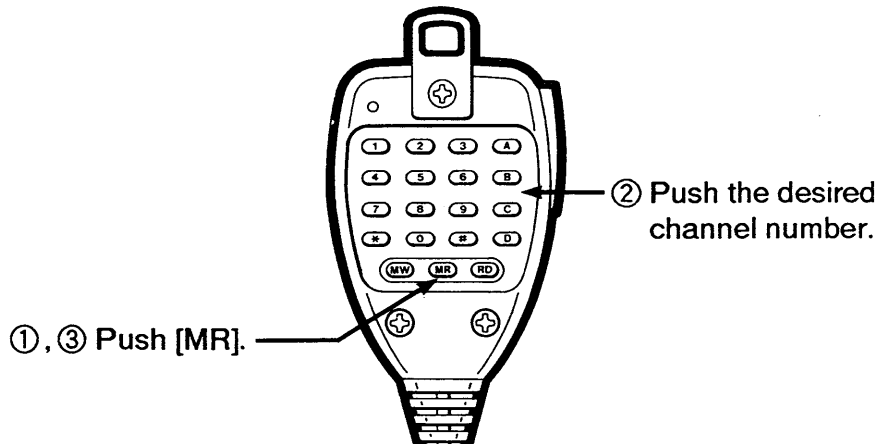

Convenient

The DTMF memory channel may be useful for optional mic DTMF remote. (p. 42)

◇ DTMF memory clearing

- ① Push [MW] on the microphone to select the memory write mode.
 - The active indicator blinks rapidly.
- ② Push and hold the PTT switch until step ④.
- ③ Push the desired DTMF memory channel number to be cleared.
 - The active indicator goes out.
- ④ Release the PTT switch.
 - The active indicator blinks rapidly.
- ⑤ Push [MW] to return to the normal mode.
 - The active indicator goes out.

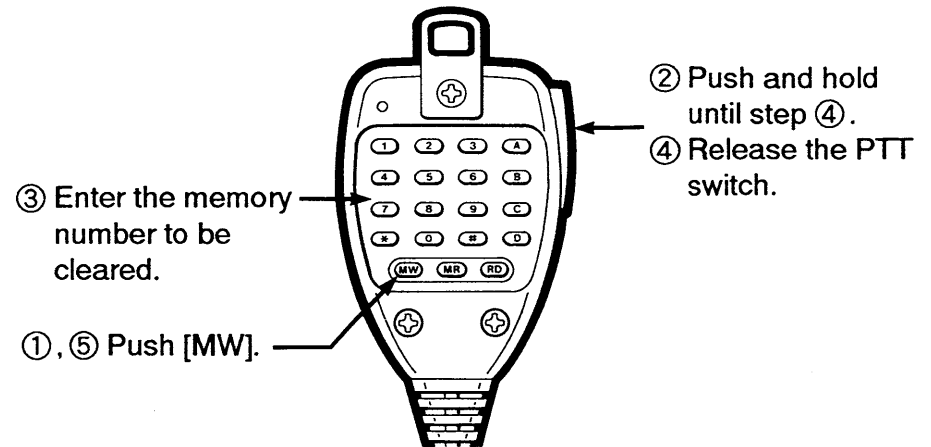

■ Re-dialing

The re-dial memory channel automatically memorizes up to 22-digit, last-transmitted DTMF code.

◇ Manual re-dialing

The last-transmitted DTMF code can be transmitted by manual key operation.

- ① Push and hold the PTT switch.
- ② Push [RD] to transmit the last-transmitted DTMF code.
 - The active indicator blinks while transmitting a DTMF code.

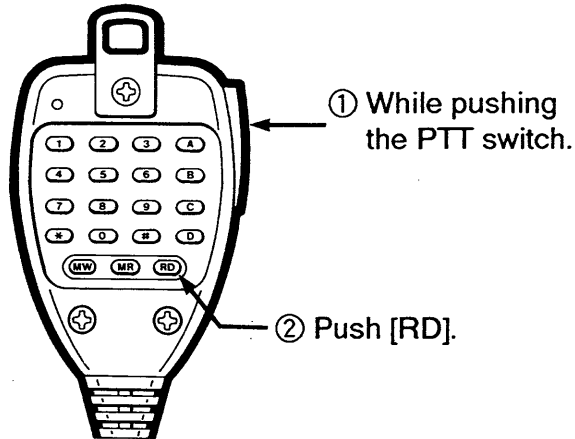

◇ Auto re-dialing

The last-transmitted DTMF code can be automatically transmitted at each push of the PTT switch.

- ① Push [RD] to select the re-dial mode.
 - The active indicator blinks slowly.
- ② At each push of the PTT switch, the last-transmitted DTMF code is transmitted.
- ③ Push [RD] to cancel the function and return to the normal mode.
 - The active indicator goes out.

◇ Writing a re-dial memory

Although last-transmitted DTMF codes are automatically written into the re-dial memory, manual writing without transmission is also possible.

Push [RD] instead of the DTMF memory channel number key in "DTMF memory writing" step ③. (p. 38)

NOTE: When transmission is interrupted while pushing the DTMF digits, the re-dial memory starts programming from the next-entered digit.

■ 1750 Hz tone call

Some European repeaters require a 1750 Hz tone for access before voice transmitting.

- ① Push [MR] to select the memory read mode.
 - The active indicator lights.
- ② Transmit a 1750 Hz tone in either of the following ways:
 - Push and hold [#] to transmit a continuous tone.
 - Push [*] to transmit a tone for approx. 0.5 sec.
- ③ Push [MR] to return to the normal mode.
 - The active indicator goes out.

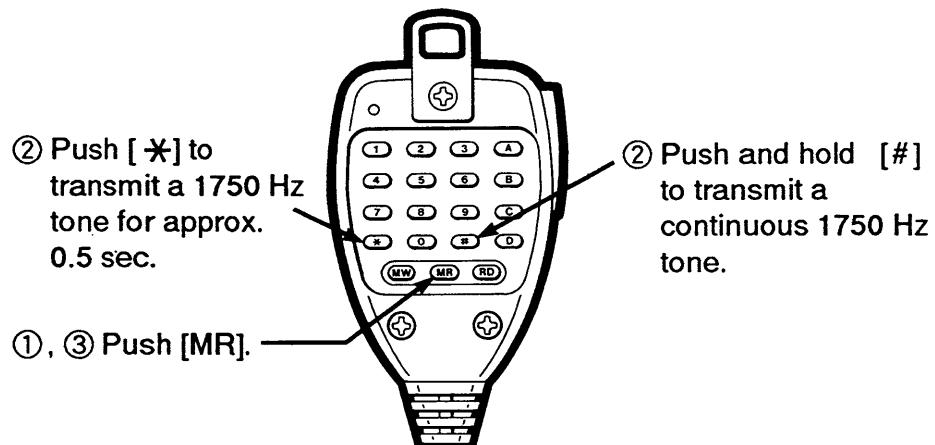

■ Microphone CPU resetting

NOTE: Microphone CPU resetting clears all DTMF memory channels and the re-dial memory channel.

- ① Turn the power OFF.
- ② While pushing and holding [MW] and [MR] on the microphone, turn the power ON.

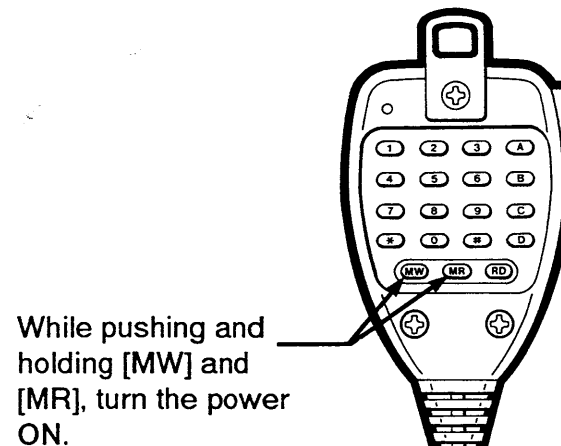

■ General description

The IC-2340H/A/E can be remotely controlled using DTMF codes.

There are 2 remote control functions:

◇ Mic DTMF remote

Controls the IC-2340H/A/E from the connected microphone. The HM-77/A DTMF MICROPHONE and optional UT-55 DTMF ENCODER/DECODER UNIT are required.

◇ External DTMF remote

Controls the MAIN band's functions from another 144 or 430 (440) MHz transceiver equipped with the DTMF encoder. An optional UT-55 DTMF ENCODER/DECODER UNIT is required.

NOTE:

- The HM-77/A is optional for non-U.S.A. and non-Korea versions.
- Attach the supplied microphone sheet to the HM-77/A keyboard for operating convenience.
- In some countries, external DTMF remote may be contrary to radio law. Ask your Icom Dealer for details concerning your area of operation.

■ Mic DTMF remote operation

- ① Push [DTMF] several times until "REMO" appears to select the remote standby condition.
- ② Set [LOCK] on the microphone to the "OFF" position.
- ③ Push [UP] on the microphone to activate mic DTMF remote.

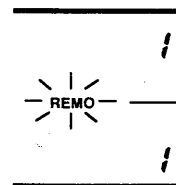

"REMO" blinks.

- ④ Push the desired key on the microphone as on p. 44 "Remote function tables."
- ⑤ Push [UP] or [DTMF] to return to the remote standby condition.
 - "REMO" appears continuously.
- ⑥ Push [DTMF] 1 time to cancel the remote standby condition.
 - "REMO" disappears.

NOTE:

- Up switch remote cannot be activated while "REMO" appears or blinks.
- The tuning dials and all switches including the PTT switch are electronically locked while "REMO" blinks.
- Scan cannot operate while "REMO" blinks. [DN] starts scanning when "REMO" appears continuously.

External DTMF remote presetting

U.S.A. version only

What are control and operation bands?

Control band	The SUB band is used as the control band for control signal (DTMF code) receiving.
Operation band	The MAIN band is used as the operation band for voice transmitting and receiving.

Password setting

To prevent unauthorized control, program a 3-digit password into code channel 5, if required. The initial setting before shipping is "000." If the password is not required, set code channel 5 as "receive inhibit." (p. 35)

Control and operation band settings

- ① Push the control band's tuning dial.
 - "MAIN" appears for the control band.
- ② Set the control band's frequency.
- ③ Push the operation band's tuning dial.
 - "MAIN" appears for the operation band.
- ④ Set the operation band's frequency.
- ⑤ Set the operating frequency of the controlling transceiver to the control band's (SUB band's) frequency.

External DTMF remote operation

U.S.A. version only

- ① Set control and operation frequencies in advance as at left.
- ② Push [DTMF] several times until "REMO" appears to select the remote standby condition.
- ③ From the controlling transceiver, transmit DTMF codes as follows.
 - "SUB" and "REMO" blink during external DTMF remote operation.
 - Refer to p. 44 "Remote function tables" for each command.

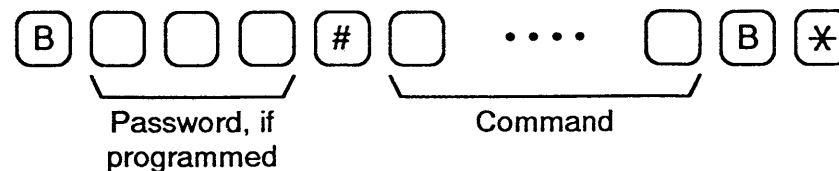

- ④ Push [DTMF] 1 time to cancel the remote standby condition.
 - "REMO" disappears.

NOTE:

- The tuning dials and all switches including the PTT switch are locked while "SUB" and "REMO" blink.
- If an optional UT-89 TONE SQUELCH UNIT is installed, the tone squelch function can be used for the control band to increase remote control reliability. (p. 31)

Remote function tables

[1] (CALL)	Selects the call channel for the MAIN band.	[D] (ENT)	- Allows you to set the MAIN band's frequency while in VFO mode.
[2] (MR)	Selects MEMORY mode for the MAIN band.		- Allows you to set the MAIN band's memory channel or scan edge channel while in MEMORY mode.
[3] (VFO)	Selects VFO mode for the MAIN band.	Pushing [D] then [0] - [9]	- Sets the MAIN band's operating frequency while in VFO mode.
[4] (VHF)*	Selects the VHF band as the MAIN band.		- Sets the MAIN band's memory channel or scan edge channel (refer below) while in MEMORY mode.
[5] (UHF)*	Selects the UHF band as the MAIN band.	[#] (UP) [*] (DOWN)	- Increases or decreases the MAIN band's operating frequency while in VFO mode.
[6] (HIGH)	Selects high power for the MAIN band.		- Increases or decreases the MAIN band's memory channel number while in MEMORY mode.
[7] (V·MONI)*	Opens and closes the VHF band's squelch.	[#] (UP) [*] (DOWN)	- Selects a duplex or simplex scratch pad memory while a call channel is selected.
[8] (U·MONI)*	Opens and closes the UHF band's squelch.		
[9] (LOW)	Selects low 1 (lowest) power for the MAIN band.		
[0] (MUTE)*	Mutes both the VHF and UHF bands's audio.		
[A] (CLR)	Clears key input before entry.		
[C] (SPEECH)*	Announces the MAIN band frequency when an optional UT-66 VOICE SYNTHESIZER UNIT is installed.		

*While mic DTMF remote only.

◇ Inhibited entry

In the following cases, the entered digits are cleared and the previous frequency or memory channel appears.

- If the entered frequency is out of the frequency coverage.
- If the entered memory channel number is 00 or larger than 52.

◇ Minimum-selectable digit

The minimum-selectable digit is 10 kHz during digit key entry.

◇ Scan edge channel selection

To select scan edge channel 1A or 1b, enter memory channel number 51 or 52, respectively.

Remote operation examples

◇ Mic DTMF remote examples

The HM-77/A DTMF MICROPHONE is required.

[Example 1]

Setting the VHF band frequency to 145.0125 MHz.

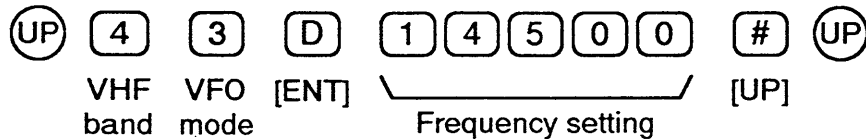

Set the VHF band tuning step to 12.5 kHz in advance.
 (p. 13)

[Example 2]

Setting the UHF band memory channel 5.

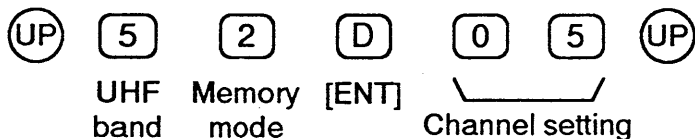

◇ External DTMF remote examples

Another 144 or 430 (440) MHz transceiver equipped with a DTMF encoder is required.

[Example 1]

When the password "123" is programmed, setting the operation band (MAIN band) to low output power.

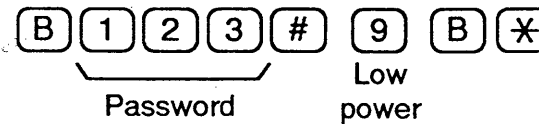

[Example 2]

When a password is not programmed, setting the operation band's (MAIN band's) call channel to high output power.

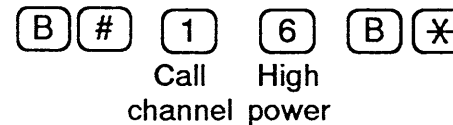

Display dimmer

SET mode

V/U Common

4 levels of function display intensity are selectable.

- ① Push [SET] several times until "d" appears.
 - Refer to p. 50 for SET mode content details.
- ② Rotate the VHF band's tuning dial to set an intensity level.

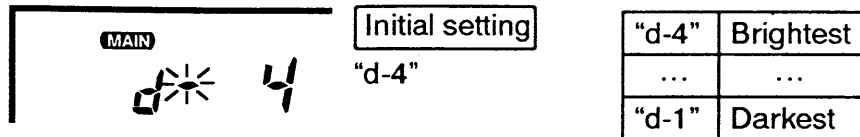

- ③ Push either band's tuning dial to exit SET mode.

Optional voice synthesizer

This function announces an operating frequency in English or Japanese. Install an optional UT-66 VOICE SYNTHESIZER UNIT in advance. (p. 10)

- ① Push the desired band's tuning dial.
- ② Push [SPCH] to announce the MAIN band's operating frequency.
 - 4 speech conditions are selectable. Refer to "Speech condition" at right.

Speech condition

INITIAL SET mode

V/U Common

When an optional UT-66 VOICE SYNTHESIZER UNIT is installed, 4 speech conditions are selectable.

- ① While pushing and holding [SET], turn the power ON to enter INITIAL SET mode.
- ② Push [SET] several times until "SPC" appears.
- ③ Rotate the VHF band's tuning dial to set a speech condition.

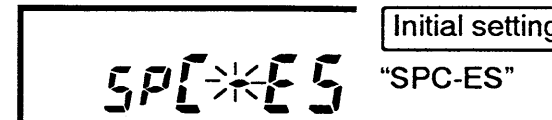

"SPC-ES"	English, slower
"SPC-EF"	English, faster
"SPC-JS"	Japanese, slower
"SPC-JF"	Japanese, faster

- ④ Turn the power OFF to exit INITIAL SET mode.

■ Beep tones

INITIAL SET mode

V/U Common

To inform you which band is operating, low beep tones or high beep tones are emitted for the VHF or UHF band, respectively. These beep tones can be muted, if required.

- ① While pushing and holding [SET], turn the power ON to enter INITIAL SET mode.
- ② Push [SET] several times until "bEP" appears.
- ③ Rotate the VHF band's tuning dial to set beep tone condition.

bEP*on		Initial setting
"bEP-on"		"bEP-on"
"bEP-on"	Beep tones are emitted.	
"bEP-oF"	Beep tones are muted.	

- ④ Turn the power OFF to exit INITIAL SET mode.

■ Mono band operation

Not required band can be deactivated for easier operation.

- ① Turn the power OFF.
- ② While pushing and holding not required band's tuning dial, turn the power ON to deactivate.

◆ Activating a band

- ① Turn the power OFF.
- ② While pushing and holding the deactivated band's tuning dial, turn the power ON.

■ Time-out timer

INITIAL SET mode

V/U Common

This function prevents accidental continuous transmitting.

- ① While pushing [SET], turn the power ON to enter INITIAL SET mode.
- ② Push [SET] several times until "tot" appears.
- ③ Rotate the VHF band's tuning dial to set a time-out time or cancel the function.

tot*oF		Initial setting
"tot-oF"		"tot-oF"

"tot-oF"	Time-out timer is cancelled.
"tot-03," "tot-05," "tot-15" or "tot-30"	If the PTT switch is continuously pushed and held for 3, 5, 15 or 30 min., transmitting is stopped.

- ④ Turn the power OFF to exit INITIAL SET mode.

Auto power-off *INITIAL SET mode*

V/U Common

This function automatically turns the power OFF to preserve your vehicle's battery power after the selected period in which no operation is performed.

- ① While pushing [SET], turn the power ON to enter INITIAL SET mode.
- ② Push [SET] several times until "PoF" appears.
- ③ Rotate the VHF band's tuning dial to set an auto power-off time or cancel the function.



"PoF-oF"	Auto power-off is cancelled.
"PoF-30," "PoF-1H" or "PoF-2H"	The transceiver automatically turns the power OFF after 30 min., 1 hr. or 2 hrs. in which no operation is performed.

- ④ Turn the power OFF to exit INITIAL SET mode.

Cooling fan *INITIAL SET mode*

V/U Common

This setting allows you to select cooling fan operating conditions.

- ① While pushing [SET], turn the power ON to enter INITIAL SET mode.
- ② Push [SET] several times until "FAn" appears.
- ③ Rotate the VHF band's tuning dial to set auto rotation or continuous rotation.



"FAn-At"	The Colling fan rotates while transmitting and for 3 min. after transmitting.
"FAn-on"	The cooling fan rotates while the power is ON.

- ④ Turn the power OFF to exit INITIAL SET mode.

Demonstration indication

This function gives you a quick visual introduction to the function display indicators.

- ① While pushing the VHF and UHF bands' [VOL]'s, and [SET], turn the power ON.
- ② Push any switch to stop the demonstration indication and enter the normal operating condition temporarily.

NOTE: The transceiver returns to demonstration indication after 2 min. in which no operations are performed. This condition continues even when the power is turned OFF and ON again. Perform step ① to cancel.

18 MODE ARRANGEMENT CHART

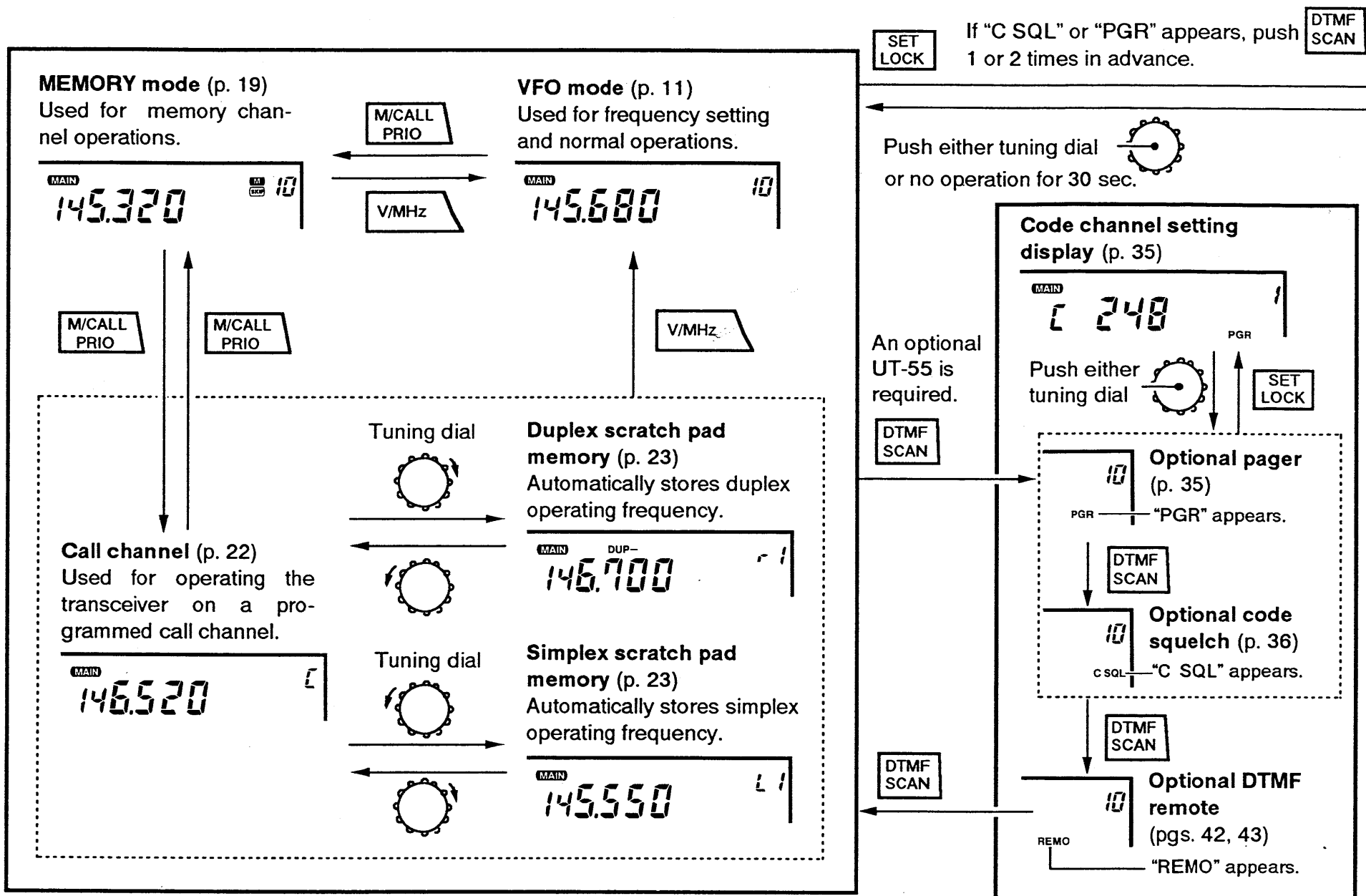

SET mode

<p>Subaudible tone frequency*¹ (p. 17)</p>	<p>Offset frequency (p. 17)</p>
<p>Display dimmer (p. 46)</p>	<p>Tuning step selection*² (p. 13)</p>
<p>SUB band mute and SUB band beep (p. 30)</p>	<p>Scan resume condition (p. 27)</p>
<p>Full/programmed scan selection*² (p. 25)</p>	<p>Skip channel setting*³ (p. 27)</p>

*¹ Non-U.S.A. versions do not have this setting without an optional tone unit.
 *² Selectable only when entering SET mode from VFO mode.
 *³ Selectable only when entering SET mode from MEMORY mode.

INITIAL SET mode

<p>Voice synthesizer*⁴ (p. 46)</p>	<p>Beep tone (p. 47)</p>
<p>Cooling fan (p. 48)</p>	<p>Time-out timer (p. 47)</p>
<p>Auto power-off (p. 48)</p>	<p>Auto repeater*⁵ (p. 18)</p>

*⁴ Appears when an optional UT-66 is installed.
 *⁵ Appears for the U.S.A. version only.

+ power ON to enter INITIAL SET mode.

Power OFF to exit INITIAL SET mode.

NOTE: If the optional code squelch or pager function is in use, SET mode cannot be selected. In this case, push [DTMF] 1 or 2 times to cancel the function in advance.

■ Troubleshooting

If your transceiver seems to be malfunctioning, please check the following points before taking the transceiver for repair.

Problem	Possible cause	Solution	Ref.
<ul style="list-style-type: none"> • No power comes on. 	<ul style="list-style-type: none"> • Power connector has a poor contact. • Polarity of the power connection is reversed. • Blown fuse. 	<ul style="list-style-type: none"> • Check the connector pins. • Reconnect the power cable observing the proper polarity. Replace the fuse, if blown. • Check the cause, then replace the fuse. 	<p>—</p> <p>pgs. 8, 53 p. 53</p>
<ul style="list-style-type: none"> • No sound comes from the speaker. 	<ul style="list-style-type: none"> • Volume level is low. • The squelch level is set too tight. • The optional pocket beep, tone squelch pager or code squelch is activated. • The mute function is in use. 	<ul style="list-style-type: none"> • Rotate the desired band's [VOL] clockwise. • Rotate the desired band's [SQL] clockwise until the noise is just muted. • Cancel the appropriate function. • Push [MUTE] to cancel the mute function. 	<p>p. 14 p. 14</p> <p>pgs. 31, 35, 36 p. 14</p>
<ul style="list-style-type: none"> • SUB band signals are not heard. 	<ul style="list-style-type: none"> • The SUB band mute function is activated. 	<ul style="list-style-type: none"> • Perform either way: <ul style="list-style-type: none"> - Push the SUB band's tuning dial to select the current SUB band as the new MAIN band. - Cancel the SUB band mute function. 	<p>—</p> <p>p. 30</p>
<ul style="list-style-type: none"> • Sensitivity is low and only strong signals are heard. 	<ul style="list-style-type: none"> • Coaxial cable or the antenna connector solder has a poor contact or is short circuited. 	<ul style="list-style-type: none"> • Check, and if required, replace the coaxial cable or solder the antenna connector again. 	<p>p. 9</p>
<ul style="list-style-type: none"> • No contact possible with another station. 	<ul style="list-style-type: none"> • The transceiver is set to duplex. • The other station is using pocket beep, tone squelch pager or code squelch. 	<ul style="list-style-type: none"> • Set to simplex. • Activate the appropriate function. 	<p>p. 15 pgs. 31, 35, 36</p>
<ul style="list-style-type: none"> • Cannot transmit. 	<ul style="list-style-type: none"> • The optional mic DTMF remote is in use. 	<ul style="list-style-type: none"> • Push [UP] on the microphone to return to remote standby condition. 	<p>p. 42</p>

Problem	Possible cause	Solution	Ref.
<ul style="list-style-type: none"> • Repeater cannot be accessed. 	<ul style="list-style-type: none"> • Wrong offset frequency is elected. • Wrong offset frequency is programmed. • Wrong subaudible tone frequency is programmed. 	<ul style="list-style-type: none"> • Correct the offset direction. • Correct the offset frequency. • Correct the subaudible tone frequency. 	<p>p. 16 p. 17 p. 17</p>
<ul style="list-style-type: none"> • Frequency cannot be set via both tuning dial and microphone. 	<ul style="list-style-type: none"> • The frequency lock function is activated. • Priority watch is paused on the watching frequency. 	<ul style="list-style-type: none"> • Push and hold [SET•LOCK] until 2 "L" 's disappear to unlock. • Push [M/CALL•PRIO] to resume the priority watch. 	<p>p. 13 p. 29</p>
<ul style="list-style-type: none"> • Frequency cannot be set via microphone. 	<ul style="list-style-type: none"> • Up switch remote is in use. • [LOCK] on the microphone is in the "ON" position. • Optional remote standby condition is selected. 	<ul style="list-style-type: none"> • Cancel up switch remote. • Set [LOCK] to the "OFF" position. • Push [DTMF] 1 time to cancel the remote 	<p>p. 37 p. 12 pgs. 42, 43</p>
<ul style="list-style-type: none"> • Scan does not operate. 	<ul style="list-style-type: none"> • Squelch is open. • For programmed scan: The same frequency is programmed into both scan edge channels 1A and 1b. • For memory scan: <ul style="list-style-type: none"> - Less than 2 memory channels are programmed. - Less than 2 memory channels are non-skip channels. 	<ul style="list-style-type: none"> • Rotate the desired band's [SQL] clockwise until the noise is just muted. • Program different frequencies into the scan edge channels 1A and 1b. • Perform either way: <ul style="list-style-type: none"> - Program more than 2 memory channels. - Set more than 2 memory channels as non-skip channels. 	<p>p. 14 p. 25 p. 26 p. 27</p>
<ul style="list-style-type: none"> • SET mode cannot be selected. 	<ul style="list-style-type: none"> • The optional pager or code squelch function is in use. 	<ul style="list-style-type: none"> • Cancel the optional pager or code squelch function. 	<p>p. 50</p>

■ Partial resetting

Partial resetting initializes VFO's only.

To perform partial resetting, while pushing either band's tuning dial + [SPCH], turn the power ON.

VFO's	Frequencies and SET mode settings are initialized.
Memory channels Scan edge channels Call channels Duplex scratch pads Simplex scratch pads	All contents remain, unchanged.

■ Total resetting

NOTE: Total resetting clears and initializes VFO's and all channel frequencies, SET mode and INITIAL SET mode settings to initial settings before shipping. Perform only when the internal CPU malfunctions.

To perform total resetting, while pushing [SET] + [SPCH], turn the power ON.

■ Cleaning

When the transceiver becomes dusty or dirty, wipe it clean with a dry, soft cloth.

■ Fuse replacement

If a fuse blows, find the source of the problem, then replace the blown fuse with a new, rated fuse (FGB 15 A).

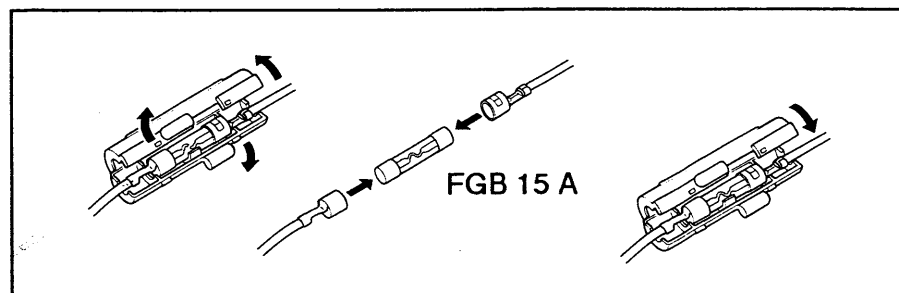

■ Lithium battery

◇ Transceiver

Internal EEPROM (Electrically-Erasable Programmable Read-Only Memory) retains VFO's and all channel contents. There is no lithium battery in the transceiver.

◇ HM-77/A DTMF MICROPHONE

The HM-77/A DTMF MICROPHONE has a lithium backup battery for retaining DTMF memory and re-dial memory contents. When the battery is exhausted, these memory contents are erased. The usual life of the battery is more than 5 years. Ask your Icom Dealer or Service center for backup battery replacement. **NEVER** replace it yourself.

◇ General

- Frequency coverage :

Version		VHF	UHF
U.S.A.		144–148 MHz	440–450 MHz
Korea		144–146 MHz	435.075–440 MHz
Australia		144–148 MHz	430–440 MHz
Asia	Transmit	144–148 MHz	430–440 MHz
	Receive	136–174 MHz* ¹	
Europe		144–146 MHz	430–440 MHz
Italy	Transmit	144–148 MHz	430–440 MHz
	Receive	136–174 MHz* ¹	

*¹ Specifications guaranteed 144–148 MHz.

*² Specifications guaranteed 430–440 MHz.

- Mode : FM
- Antenna impedance : 50 Ω (nominal)
- Power supply requirement : 13.8 V DC ± 15%
- Usable temperature range : - 10 °C to + 60 °C; + 14 °F to + 140 °F
- Dimensions : 140(W) × 40(H) × 165(D) mm
(projections not included) 5.5(W) × 1.6(H) × 6.5(D) in
- Weight : 1.3 kg; 2.9 lb

◇ Transmitter

- Modulation system : Variable reactance frequency modulation
- Max. frequency deviation : ± 5.0 kHz
- Spurious emissions : Less than - 60 dB
- Microphone impedance : 600 Ω

- Output power and current drain :

Condition		IC-2340H		IC-2340A/E	
		Power	Current	Power	Current
VHF	High	45 W	10.5 A	25 W	7.0 A
	Low 2	10 W	5.5 A	10 W	4.5 A
	Low 1	5 W	4.0 A	1 W	2.5 A
UHF	High	35 W	10.5 A	25 W	8.0 A
	Low 2	10 W	6.0 A	10 W	5.0 A
	Low 1	5 W	4.5 A	1 W	3.0 A

◇ Receiver

- Receive system : Double-conversion superheterodyne
- Intermediate frequencies : 1st: 17.2 MHz (VHF), 30.85 MHz (UHF), 2nd: 455 kHz (VHF/UHF)
- Sensitivity : Less than 0.16 μV for 12 dB SINAD
- Squelch sensitivity : Less than 0.13 μV at threshold
- Selectivity : More than 15 kHz/ - 6 dB
Less than 30 kHz/ - 60 dB
- Spurious response rejection : More than 60 dB
- Audio output power : More than 2.4 W at 10% distortion with an 8 Ω load
- Current drain : Rated audio output on 2 bands
1.8 A
Squelched on 2 bands
1.2 A

All stated specifications are subject to change without notice or obligation.

Unpacking

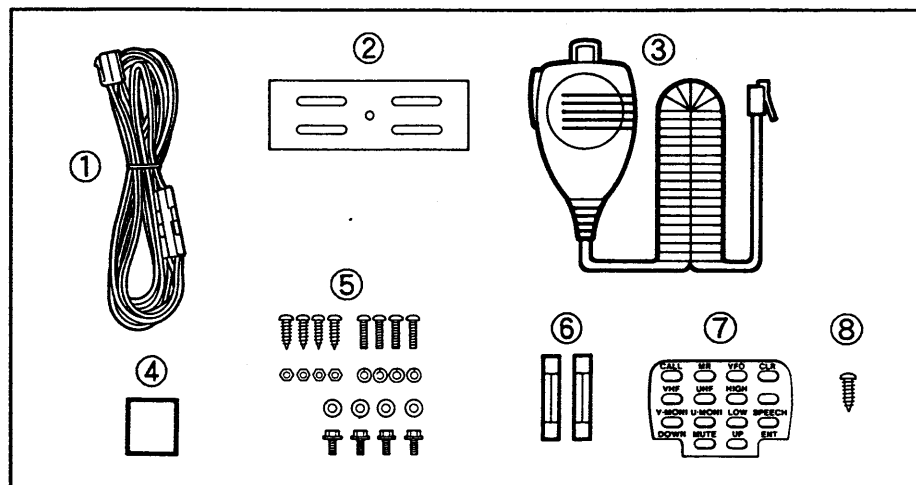

Accessories included with the transceiver: Qty.

- ① DC power cable (OPC-345) 1
- ② Mounting bracket (MB-59) 1
- ③ Microphone* 1
- ④ Velcro tape 1
- ⑤ Mounting screws, nuts and washers 1 set
- ⑥ Fuses (FGB 15 A) 2
- ⑦ Microphone sheet 1
- ⑧ Screw for microphone connector attachment 1

*Supplied microphone varies according to version:

- U.S.A. HM-77
- Korea HM-77
- Australia, Asia HM-78
- Europe, Italy HM-79

Options

SP-7 EXTERNAL SPEAKER

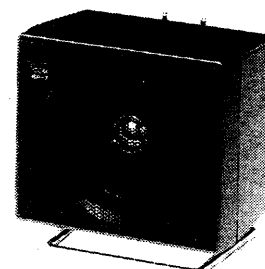

Suitable for base station operation.
Impedance: 8 Ω Input: 5 W

SP-10 EXTERNAL SPEAKER

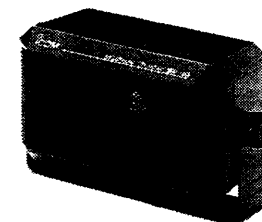

Provides excellent audio in your vehicle.
Impedance: 4 Ω Input: 5 W

SP-12 EXTERNAL SPEAKER

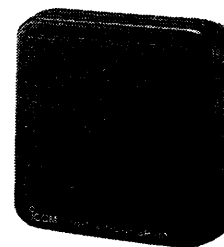

Slim-type speaker for mobile operation. Can be installed on a sun visor, dashboard, etc.
Impedance: 8 Ω Input: 3W

MB-17A MOBILE MOUNTING BRACKET

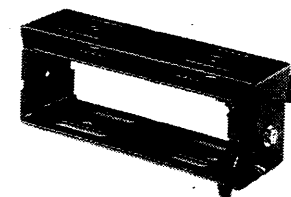

One-touch bracket. Transceiver can be easily attached and removed.

AH-32 DUAL BAND MOBILE ANTENNA

For VHF/UHF mobile operation. The AHB-32 is required.
Frequency range : 144–148 MHz and 430–450 MHz
Max. input power : 150 W

AHB-32 TRUNK MOUNT

Trunk mount with a coaxial cable for the AH-32.

HM-77/A DTMF MICROPHONE

Same as supplied with the U.S.A. and Korea versions. Has a DTMF keyboard, 14 DTMF memory channels and the 1750 Hz tone call function. When used with the UT-55, also provides mic DTMF remote.

HM-78 HAND MICROPHONE

Same as supplied with the Asia and Australia versions.

HM-79 HAND MICROPHONE

Same as supplied with the Europe and Italy versions. Has a 1750 Hz tone call function.

MB-59 MOBILE MOUNTING BRACKET

Same as supplied with the IC-2340H/A/E.

OPC-345 DC POWER CABLE

Same as supplied with the IC-2340H/A/E.
Cable length : 3 m; 9.8 ft

OPC-440 MICROPHONE CABLE

Extends the microphone cable.
Cable length : 5.0 m; 16.4 ft

IC-PS30 DC POWER SUPPLY

System power supply. Suitable for base station operation. Equipped with 3 output connectors.
Output voltage : 13.8 V DC
Max. current : 25 A

UT-55 DTMF ENCODER/DECODER UNIT

Provides pager, code squelch functions and external DTMF remote. When used with the HM-77/A, also provides mic DTMF remote.

UT-66 VOICE SYNTHESIZER UNIT

A clear, electronically-generated voice announces the operating frequency in English or Japanese.

UT-89 TONE SQUELCH UNIT

Provides pocket beep and tone squelch functions. Also functions as a subaudible tone encoder. Contains separate circuits for each band.

Count on us!

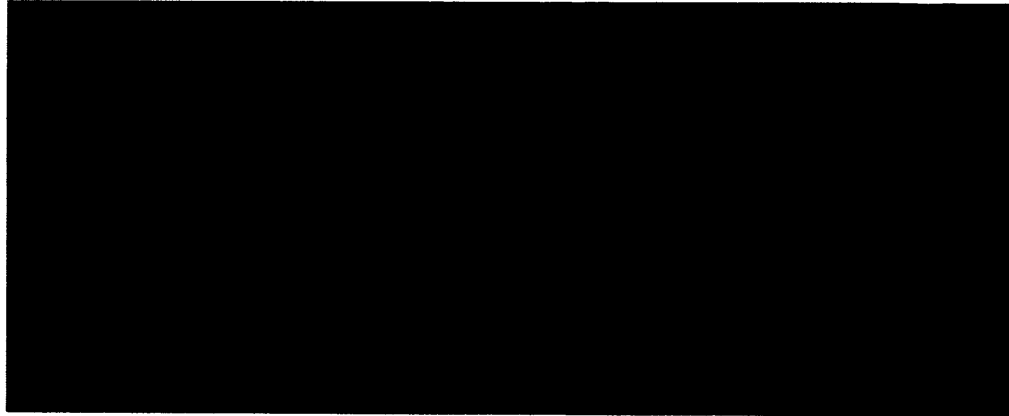

A-5278S-1EX-①
Printed in Japan
Copyright © 1994 by Icom Inc.

Icom Inc.
6-9-16, Kamihigashi, Hirano-ku, Osaka 547, Japan
