

ASSEMBLY AND INSTALLATION



ARX-2B **ARX-220B**

RINGO RANGER II ANTENNA



PARTS PACKAGE ARX-2B, ARX-220B















P/N	KEY	DISPLAY	DISC	ARX-2B SIZE	ARX-220B SIZE	QTY
010009	9		MACHINE SCREW	8-32 x 5/8" (1.6 cm)	8-32 x 5/8" (1.6 cm)	3
011941	41		LOCK WASHER	#8	#8	3
010011	11		HEX NUT	#8-32	#8-32	4
200067	67		TUNING ROD CLAMP			1
010081	81		MACHINE SCREW	1/4"-20 x 3/4" (1.9 cm)	1/4"-20 x 3/4" (1.9 cm)	1
010084	84		LOCK WASHER	1/4" (0.64 cm)	1/4" - 20 (.64 cm)	3
010085	85		HEX NUT	1/4" - 20 (0.64 cm)	1/4" - 20 (0.64 cm)	3
012965	65		LOCK NUT	1/4" - 20 (.64 cm)	1/4" (0.64 cm)	1
080097	97		FORMED TUNING ROD	3/16" x 5" (0.48 x 12.7 cm)	3/16" x 5" (0.48 x 12.7 cm)	1
AR2AA	AA		BASE SECTION ASSEMBLY			1
AR2GG	GG		TUNING RING			1
	JJ		ALUM. RADIAL RODS	082970 1/4" x 20 1/2" (0.64 x 52.1 cm)	082984 1/4" x 13 1/4" (0.64 x 33.7 cm)	3
902560	KK		RADIAL RING ASSEMBLY			1
240116	116		SILICONE GREASE			1
	HH		50 Ohm CABLE w/ CONN. & BOOTS	ARX2BHH 50 1/2" (128.2 cm)	ARX220BHH 33" (83.8 cm)	1

FIGURE 1

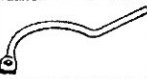
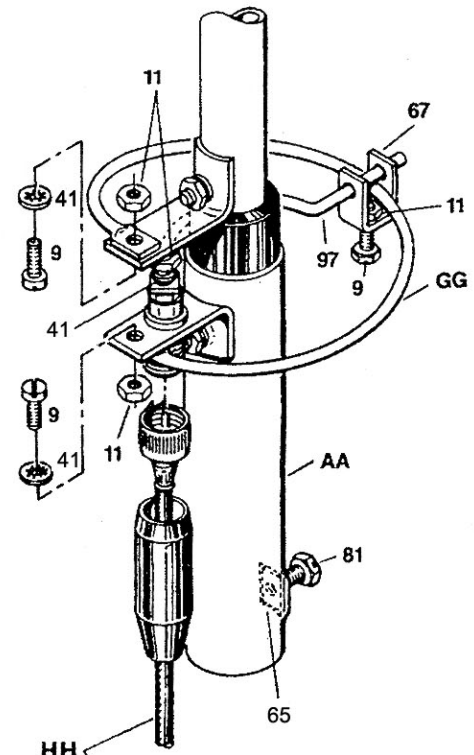
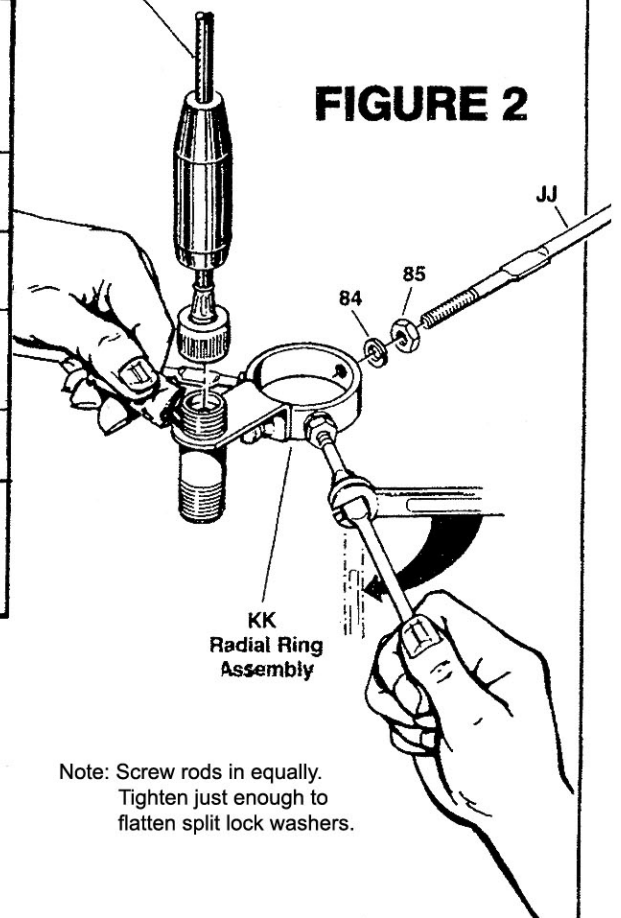

FIGURE 2



Note: Screw rods in equally.
Tighten just enough to flatten split lock washers.

Your Cushcraft Ringo Ranger II is designed and manufactured to give top performance and trouble free service. The antenna will perform as specified if the instructions and suggestions are followed and care is used in assembly and installation.

MASTING

The ARX2B and ARX-220B will take up to a $1\frac{3}{8}$ " (3.5cm) OD mast. This is a close tolerance "slip fit". Make sure your mast and base bottom tube are smooth, round and free of any dirt or binding may occur.

For most installations a $1\frac{1}{4}$ " (3.2cm) OD TV type mast will be satisfactory. A total of 55" (139.7cm) of exposed mast is necessary to install the ARX-2B, The ARX-220B requires 38" (91.4 CM).

LOCATION

Location of the antenna is very important. Surrounding objects such as trees, power lines, other antennas, etc. will seriously reduce efficiency. To minimize the effects of surrounding objects, mount the antenna as high and in the clear as possible, If metal guy wires are used, they should be at minimum, 6' below your radials. **WARNING: THIS ANTENNA IS AN ELECTRICAL CONDUCTOR, CONTACT WITH POWER LINES CAN RESULT IN DEATH, OR SERIOUS INJURY. DO NOT INSTALL THIS ANTENNA WHERE THERE IS ANY POSSIBILITY OF CONTACT WITH HIGH VOLTAGE ARC-OVER FROM POWER CABLES OR SERVICE DROPS TO BUILDINGS. THE ANTENNA, SUPPORTING MAST AND/OR TOWER MUST NOT BE CLOSE TO ANY POWER LINES DURING INSTALLATION REMOVAL IN THE EVENT PART OF THE SYSTEM SHOULD ACCIDENTALLY FALL. FOLLOW THE GUIDELINES FOR ANTENNA INSTALLATIONS RECOMMENDED BY THE U.S. CONSUMER PRODUCT SAFETY COMMISSION AND LISTED IN THE ENCLOSED PAMPHLET.**

MOUNTING

Mount the antenna clear of surrounding objects, the higher the better. Your Ringo Ranger may be mounted only a few feet above a horizontally polarized beam antenna. When side mounting your Ringo Ranger II on a tower, it should be spaced $\frac{1}{2}$ wave-length out from the tower.

ANTENNA ASSEMBLY

Attach the tuning ring (GG) as shown in figure 1. Assemble the tuning rod clamp (67), place it over the tuning ring (GG) and slide the rod (97) through it. Attach the flattened end to the coax connector. Be sure the tuning rod is on the side of the base shown in figure 1.

Using figure 3 assemble the radiating section. Each tube is inserted into the previous tube approximately 3 inches (7.5 cm). To assemble the phasing section, loosen the $\frac{3}{4}$ " screws in the insulator. Then insert both forks of the phasing section (FF) through the holes. Finger tighten the screws for now. Adjust the dimensions A, B, and C using Chart A. Tighten all fasteners snugly.

Assemble the radial ring as shown in figure 2. Then slide it into position and attach the hardware shown. **BE VERY CAREFUL NOT TO OVERTIGHTEN THE RADIAL RODS (JJ) OR THEIR CLAMPING NUTS (85).** Over tightening may cause permanent unwarranted damage. Install the coaxial cable (HH) between the tuning ring (GG) and the radial ring (KK). Coat the outside of all three aluminum connector threads and three PL-259s with silicone grease provided. Do not coat the connector center pins and sockets with silicone. Tighten all connections. Slide the vinyl boots over the connectors and against the plates for a good weather-tight connection. Follow the same procedure for your 50 ohm coaxial feed cable, and be sure to slide the vinyl boot over the cable before attaching the PL-259 connector. Cable losses increase with frequency, so use a "low loss" cable type.

If you plan to install the antenna in a salty or corrosive environment, you may want to consider coating it with clear marine varnish or equivalent.

TUNING

Testing and adjustment may be done on the ground using just 8' to 10' of mast. Attach a good quality VSWR Bridge to a coaxial cable as close to the antenna as practical but stand six feet away when taking readings. Note the VSWR at your frequency. Move the tuning rod $\frac{1}{4}$ " ($\frac{1}{2}$ cm) in either direction. Tighten the screws and note your VSWR. If the VSWR has increased, move the rod in the opposite direction and remeasure your VSWR. If the VSWR has decreased continue in the same direction until a minimum has been reached. If the VSWR is still above 1.5, re-check and adjust dimensions A, B and C for your frequency.

FIGURE 3

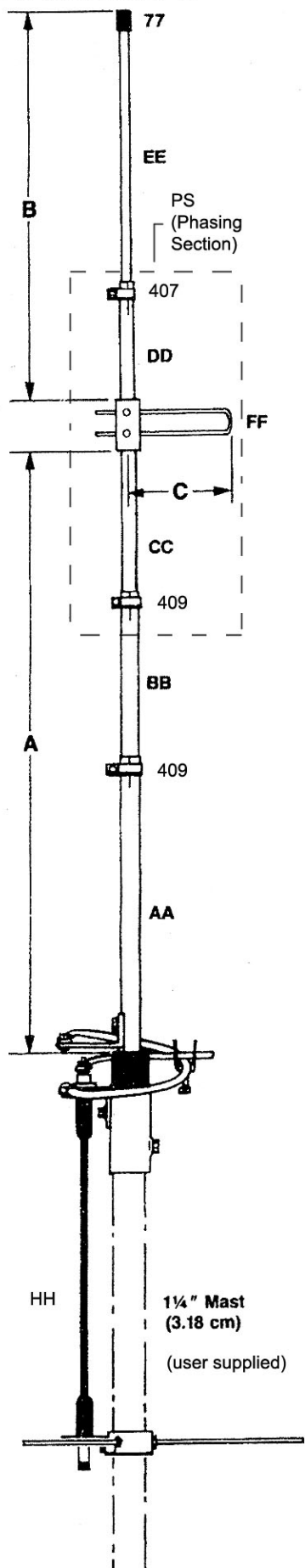

CHART A			
Freq. MHz	Dimension A	Dimension B	Dimension C
ARX-2B			
135	59 1/2" (1.51 m)	54 1/2" (1.38 m)	9 3/4" (24.8 cm)
137	58 3/4" (1.49 m)	53 3/4" (1.36 m)	9 1/2" (24.1 cm)
140	57 1/2" (1.46 m)	52 1/2" (1.33 m)	9 1/4" (23.5 cm)
142	56 3/4" (1.44 m)	51 3/4" (1.31 m)	9 1/8" (23.2 cm)
145	55 1/2" (1.41 m)	50 1/2" (1.28 m)	9" (22.9 cm)
146	55 1/8" (1.40 m)	50 1/8" (1.27 m)	8 15/16" (22.7 cm)
147	54 3/4" (1.39 m)	49 3/4" (1.26 m)	8 7/8" (22.5 cm)
150	53 1/2" (1.36 m)	48 3/4" (1.24 m)	8 3/4" (22.2 cm)
152	52 3/4" (1.34 m)	48" (1.22 m)	8 5/8" (21.9 cm)
155	51 3/4" (1.31 m)	47" (1.19 m)	8 1/2" (21.6 cm)
157	51" (1.29 m)	46 1/4" (1.17 m)	8 3/8" (21.3 cm)
160	50" (1.27 m)	45 1/2" (1.16 m)	8 1/4" (21.0 cm)
ARX-220B			
220-225	33 1/8" (84.1 cm)	32" (81.3 cm)	5 3/4" (14.6 cm)

P/N	KEY	DISPLAY	DISC	ARX-2B SIZE	ARX-220B SIZE	QTY
050077	77		PLASTIC CAP	3/8" (0.9 cm)	3/8" (0.9 cm)	1
030407	407		TELESCOPE CLAMP	1/2" (1.3 cm)	1/2" (1.3 cm)	1
030409	409		TELESCOPE CLAMP	5/8" (1.6 cm)	5/8" (1.6 cm)	2
	AA		BASE SECTION ASSEMBLY			1
	BB		ALUM. TUBING	5/8" x 15" (1.6 x 38.1 cm)	5/8" x 15" (1.59 x 38.1 cm)	1
PS	CC		ALUM. TUBING	1/2" x 21" (1.3 x 53.3 cm)	1/2" x 12" (1.2 x 30.5 cm)	1
	DD		ALUM. TUBING w/ INSULATOR	1/2" x 24" (1.3 x 70 cm)	1/2" x 12" (1.2 x 30.5 cm)	1
	EE		ALUM. TUBING	3/8" x 35" (0.9 x 88.9 cm)	3/8" x 24" (0.9 x 61 cm)	1
	FF		ALUM. PHASING STUB	ARX2BFF 10 1/2" (26.6 cm)	ARX220BFF 6 3/4" (17.1 cm)	1
290326	326		DANGER LABEL	ATTACH TO YOUR MAST AT EYE LEVEL		1

WARNING

THIS ANTENNA IS AN ELECTRICAL CONDUCTOR. CONTACT WITH POWER LINES CAN RESULT IN DEATH, OR SERIOUS INJURY. DO NOT INSTALL THIS ANTENNA WHERE THERE IS ANY POSSIBILITY OF CONTACT WITH HIGH VOLTAGE OR ARC-OVER FROM POWER CABLES OR SERVICE DROPS TO BUILDINGS. THE ANTENNA, SUPPORTING MAST AND/OR TOWER MUST NOT BE CLOSE TO ANY POWER LINES DURING INSTALLATION, REMOVAL OR IN THE EVENT PART OF THE SYSTEM SHOULD ACCIDENTALLY FALL. FOLLOW THE GUIDELINES FOR ANTENNA INSTALLATIONS RECOMMENDED BY THE U.S. CONSUMER PRODUCT SAFETY COMMISSION AND LISTED IN THE ENCLOSED PAMPHLET.

SPECIFICATIONS

MODEL	ARX2B	ARX220B
Frequency, MHz	134-164	220-225
Height, in (m)	168 (4.3)	112 (2.8)
Gain, dBd	5.5	5.5
Impedance, Ohms	50	50
2:1 VSWR Bandwidth	>3 MHz	>5 MHz
Power Rating, Watts	1000	500
Connector	UHF SO-239	UHF SO-239
Surface, ft (m)	.5 (.05)	.3 (.03)
Recommended Mast Dia, in (cm)	1.25 (3.18)	1.25 (3.18)
Weight, lb (kg)	6 (2.7)	5 (2.3)

LIMITED WARRANTY

Cushcraft Corporation, 48 Perimeter Road, Manchester, New Hampshire 03103, warrants to the original purchaser for one year from date of purchase that each Cushcraft antenna is free of defects in material or workmanship. If, in the judgement of Cushcraft, any such antenna is defective, then Cushcraft Corporation will, at its option, repair or replace the antenna at its expense within thirty days of the date the antenna is returned (at purchasers expense) to Cushcraft or one of its authorized representatives. This warranty is in lieu of all other expressed warranties, any implied warranty is limited in duration to one year. Cushcraft Corporation shall not be liable for any incidental or consequential damages which may result from a defect. Some states do not allow limitations on how long an implied warranty lasts or exclusions or limitations of incidental or consequential damages, so the above limitation and exclusion may not apply to you. This warranty gives you specific legal rights, and you may also have other rights which vary from state to state. This warranty does not extend to any products which have been subject the misuse, neglect, accident or improper installation. Any repairs or alterations outside of the Cushcraft factory will nullify this warranty.



48 PERIMETER ROAD, MANCHESTER, NH 03103 USA
TELEPHONE: 603-627-7877 - FAX: 603-627-1764 - E-mail: techsup@cushcraft.com

SPECIFICATIONS SUBJECT TO CHANGE WITHOUT NOTICE